



pamir[®]
aydınlatma



Profesyonel Aydınlatma Armatürleri
Professional Lighting Fixtures
Luminaires Professionnels

MODERN AYDINLATMA ARMATÜRLERİ
MODERN LIGHTING FIXTURES
LUMINAIRES MODERNES



Fabrika / Factory / Usine

KONYA



Karaköy Showroom

İSTANBUL

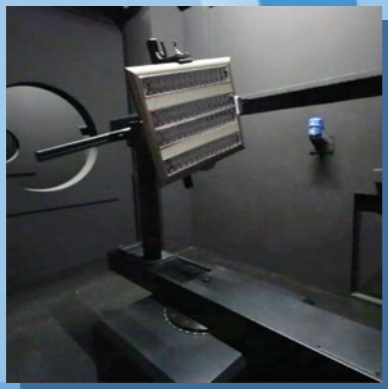
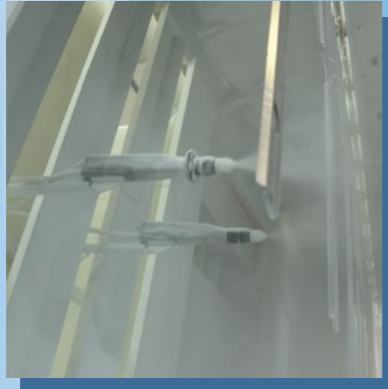
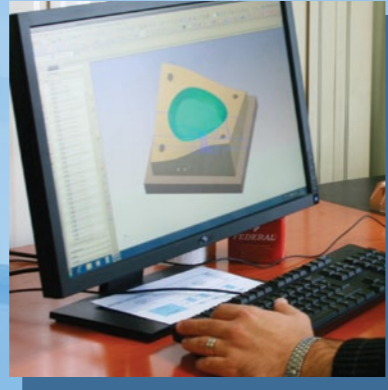

HAKKIMIZDA

PAMİR ELEKTRİK Anadolu'nun kalbinde sanayi kenti olan KONYA da yer almaktadır. 1974 yılında kurulan ve 1990 yılına kadar muhtelif elektrik malzemelerinin imalatını yapan firmamız 1990 yılından bu yana faaliyet alanını aydınlatma sektörü olarak belirlemiştir. Bugün aydınlatma sektörünün önde gelen şirketleri arasında geniş ürün yelpazesi, yüksek kaliteli ürün ve rekabetçi fiyatlarıyla yerini almıştır.

Ürün gamı:

- Ofisler ve alışveriş merkezleri için T5 floresan ve LED aydınlatma armatürleri,
- IP65 T5 ve LED Yüksek tavan aydınlatma armatürleri,
- IP65 T5/T8 ve LED Etanj floresan armatürler,
- Simit floresan armatürler,
- Glop armatürler,
- Aplikler,
- Hareket sensörü ve sensörlü armatürler,
- Manyetik ve elektronik balastlar.

GÜÇLÜ YANLARIMIZ

Firmamız, ürünleri gerekli estetik ve fonksiyonelliğin sağlanabilmesi amacıyla bilgisayar ortamında tasarlamakta ve üretiminde kaliteli malzemeler kullanmaktadır. Üretim tüm safhalarında titiz işçilik sergilenmekte ve kalite kontrol faaliyetleri yürütülmektedir.

Aldığımız her sipariş miktarına bakılmaksızın gerekli olan ilgi ve hassasiyeti görmektedir. Yaklaşık 40 yıldır bu sektörde üretim yapıyor olmamız, yurt içi ve dışı müşterilerimizden aldığımız tekrarlanan siparişler kalite ve ciddiyetimizin en önemli göstergesidir.

Sizleri tanımak ve hizmet vermekten onur duyacağız.

ABOUT US

PAMİR ELEKTRİK is located in the industrial city of KONYA, in the heart of Anatolia. Created in 1974, it was manufacturing originally some electrical equipment. However, since 1990, it shifted its production solely towards the lighting sector, and became a specialist in this field. It ranks today among the most performing Turkish companies in the sector, which offer a large array of products, combining aesthetic, quality and competitive price .

Range of products:

- T5 and LED fluorescent lighting fixtures for offices and shopping places
- IP65 T5 and LED highbay lighting fixture
- IP65 T5, T8 and LED Waterproof fluorescent lighting fixtures ,
- Circular Fluorescent and other lighting fixtures
- Glop lamps,
- Wall lamps,
- Motion sensor,
- Motion sensor lamps,
- Magnetic and electronic ballasts.

Our strengths:

PAMİR's catalogue offers a large variety of Elegant lighting fixtures, Proline lighting fixtures, circular lighting fixtures, wall lamps, waterproof lighting fixtures, motion sensor lamps... and accessories to be fitted either on the ceiling (suspended, recessed or surface mounted), or on the wall, all made with the finest materials and craftsmanship available.

We are able to conceive and offer products which combine both aesthetic and competitiveness, due to the fact that all the different stages – from conception to production are done in our factory.

All products are thought in our R&D department, by means of the latest softwares CAD/CAM and others, the moulds prepared in our own mould workshop, then once tested and approved, manufactured.

Every order – be it small or large – gets our personal attention and care down to the smallest details .

Whatever your lighting need may be, let us care for it. We have been in the business for nearly 40 years, and the repeated orders from our faithful clients both in Turkey and abroad are the best testimony for our quality and seriousness . We will be very honoured to get to know you and serve you.

NOUS CONNAITRE

PAMİR ELEKTRİK est située dans la ville industrielle de KONYA, en plein centre de l'Anatolie. Créée en 1974, elle produisait à l'origine des équipements électriques. Cependant, depuis 1990, elle s'est orientée exclusivement vers la fabrication de produits et accessoires d'éclairage.

Elle compte aujourd'hui parmi les entreprises turques les plus performantes et celles qui offrent une gamme de produits variés, alliant esthétique, qualité et prix .

Gamme de produits:

- Luminaires fluorescents T5 et LED pour bureaux et centres commerciaux,
- IP65 T5 et LED Luminaires Grande Hauteur,
- Luminaires étanches T8, T5 et LED IP65,
- Hublots muraux,
- Hublots,
- Détecteur De Mouvement,
- Hublots avec détecteur intégré,
- Plafonniers,
- Appliques,
- Ballasts magnétiques et électroniques.

Nos atouts:

Le catalogue de PAMİR montre une large gamme de luminaires, luminaires étanches, hublots avec détecteur de mouvement, hublots, appliques... et accessoires, suspendus et/ou encastrés à fixer au plafond, des appliques et hublots muraux, ... tous fabriqués avec des matières premières de qualité et une expertise hors pair.

Grace à l'existence au sein de la société des différentes étapes de conception et de fabrication, nous sommes en mesure de penser des produits qui allient aussi bien l'esthétique, la qualité, mais également la compétitivité.

Tous les produits sont conçus dans notre département R&D, avec l'utilisation des logiciels CAD/CAM et autres, les moules réalisés dans notre propre atelier de moulage, puis une fois testés et approuvés, fabriqués.

Chaque commande – petite ou grande – bénéficie de notre attention jusqu'au moindre détail.

Quels que soient vos besoins en éclairage, laissez nous le soin de les prendre en charge. Nous sommes dans le domaine depuis près de 40 ans, et les commandes répétées de nos fidèles clients, tant en Turquie qu'à l'Étranger, sont la meilleure preuve de notre qualité et sérieuse.

Nous serons très honorés de vous connaître et de vous servir.

GALAKSİ

SF-08
PAGE



PRİZMA

SF-26
PAGE



VEGA

SF-34
PAGE



VEGA SLIM

SF-52
PAGE



SİMETRİ

SF-60
PAGE



FLEKSİ

SF-64
PAGE



ELEGANT

SF-74
PAGE



APLİK

APPLIQUE

SF-114
PAGE



V TİPİ

V TYPE

SF-122
PAGE



STERİL

STERILE / STÉRILE

SF-126
PAGE

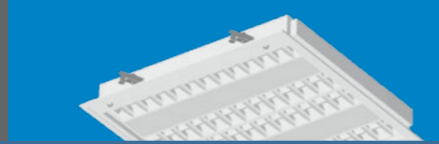

SIVA ALTI

RECESSED / ENCASTRE

SF-134
PAGE



CLIP-IN

SF-150
PAGE



TRIM LINE

SF-166
PAGE



SLIM LINE

SF-172
PAGE



PROLINE

SF-178
PAGE

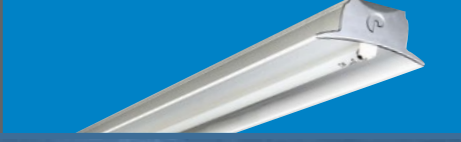

BANT

BATTEN / RÉGLETTES

SF-204
PAGE



WALL WASHER

SF-208
PAGE



ENDÜSTRİYEL

INDUSTRIAL / INDUSTRIEL

SF-212
PAGE



ETANJ

WATERPROOF / ETANCHE

SF-218
PAGE



METAL GLOP

SF-228
PAGE



SENSÖR

Sensor / Détecteur

SF-236
PAGE





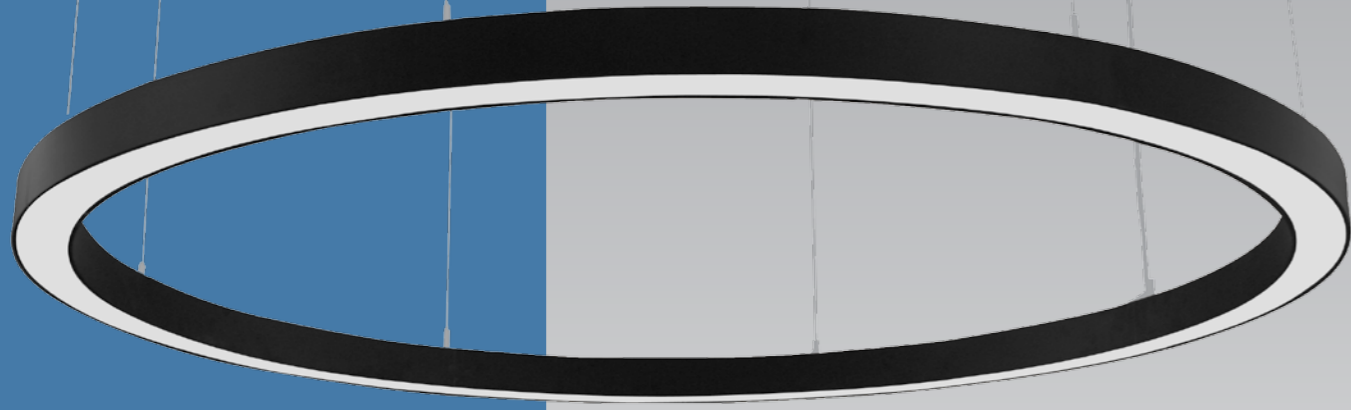

GALAKSİ O

Renk Seçenekleri
Color Options
Options de Couleur



LED

Sarkıt Buzlu Akrilik Difüzörlü Aydınlatma Armatürleri

Suspended Lighting Fixtures With Frosted Acrylic Diffuser

Luminaire Suspendus Avec Diffuseur Acrylique Givré

UYGULAMA ALANLARI

Alışveriş Merkezleri
Marketler
Ofisler
Toplantı Odaları
Mağazalar
Hastaneler
Okullar

APPLICATION AREAS

Shopping Malls
Supermarkets
Offices
Meeting rooms
Stores
Hospitals
Schools

DOMAINES D'UTILISATION

Centres Commerciaux
Supermarchés
Bureaux
Salles de Réunions
Magasins
Hopitaux
Ecoles

GÖVDE

Beyaz ve siyah renk seçenekleri ile zarif tasarıma sahip alüminyum.

DİFÜZÖR

UV korumalı akrilik difüzör.

KONVERTÖR

ENEC standartlarına uygun, uzun ömürlü sabit akımlı konvertör.

LED

50.000 saat ömürlü LUMILEDS / OSRAM / SEOUL marka LED'li LED modüller.

ASKI

1mm çelik örgü tel ve nikel kaplamalı pirinç parçalardan mamul, askı boyu ayarlanabilir, şeffaf elektrik kablosu ve tavana monte edilen estetik tasarıma sahip elektrik bağlantı kutusu ile birlikte.

BODY

Anodized aluminum with satin finishing. Black and white color options with elegant design.

DIFFUSER

UV stabilized acrylic diffuser.

CONVERTER

Long life, low power loss converter with constant current. Compatible with ENEC standards.

LED

LED modules with 50,000 hours lifetime LUMILEDS / OSRAM / SEOUL brand LEDs.

SUSPENSION

Composed of 1mm steel wire rope and nickel-plated brass components. Suspension height is adjustable. Supplied with transparent electric cord and ceiling mounted electrical junction box with aesthetic design.

CORPS

Corps en aluminium anodisé, satiné. Design élégant. Couleurs blanc, noir disponibles.

DIFFUSEUR

Diffuseur en acrylique. Anti UV.

CONVERTEUR

Convertisseur, conforme aux normes ENEC. Longue vie. Perte de puissance faible avec courant constant.

LED

Modules LED – Durée de vie 50.000 heures avec LED de marque LUMILEDS / OSRAM / SEOUL.

SYSTEME DE FIXATION

Composé d'un fil en acier de 1mm, de composants en laiton nickelés. Livré avec un cordon électrique transparent et une boîte de jonction électrique à fixer au plafond. Hauteur de fixation réglable.

LED'li Tip / LED Type / Type LED

Renk Geri Verim Indexi / Color Rendering Index / Indice de Rendu des Couleurs: (CRI): Ra>80

Kod Code	Güç Power Puissance (W)	LED Tipi LED Type Type De LED	LED Modül LED Module Module LED	Işık Akısı Lum. Flux Flux Lum. (lm)	Renk Sıcaklığı Color Temperature Température De Couleur (K)	Ölçüler Dimensions (mm) a d h	Ağırlık Weight Poids (kg)	Ambalaj Adedi Packing Quantity Colisage	Adet/20" Konteyner Pcs./20" Conteneur
PL8S06L15C	6x6,7	5630 SMD	PCB	4740	3000 / 4000 / 6500	79 620 73	3,9	1	690
PL8S06L25C	6x12,3	5630 SMD	PCB	8700	3000 / 4000 / 6500	79 620 73	3,9	1	690
PL8S08L15C	8x6,7	5630 SMD	PCB	6320	3000 / 4000 / 6500	79 800 73	5,1	1	425
PL8S08L25C	8x12,3	5630 SMD	PCB	11600	3000 / 4000 / 6500	79 800 73	5,3	1	425
PL8S010L15C	10x6,7	5630 SMD	PCB	7900	3000 / 4000 / 6500	79 980 73	6,3	1	285
PL8S010L25C	10x12,3	5630 SMD	PCB	14500	3000 / 4000 / 6500	79 980 73	6,5	1	285
PL8S012L15C	12x6,7	5630 SMD	PCB	9480	3000 / 4000 / 6500	79 1155 73	7,7	1	205
PL8S012L25C	12x12,3	5630 SMD	PCB	17400	3000 / 4000 / 6500	79 1155 73	7,9	1	205
PL8S014L15C	14x6,7	5630 SMD	PCB	11060	3000 / 4000 / 6500	79 1335 73	8,9	1	195
PL8S014L25C	14x12,3	5630 SMD	PCB	20300	3000 / 4000 / 6500	79 1335 73	9,1	1	195
PL8S016L15C	16x6,7	5630 SMD	PCB	12640	3000 / 4000 / 6500	79 1530 73	10,1	1	380
PL8S016L25C	16x12,3	5630 SMD	PCB	23200	3000 / 4000 / 6500	79 1530 73	10,3	1	380
PL8S020L15C	20x6,7	5630 SMD	PCB	15800	3000 / 4000 / 6500	79 1890 73	11,3	1	285
PL8S020L25C	20x12,3	5630 SMD	PCB	29000	3000 / 4000 / 6500	79 1890 73	11,7	1	285

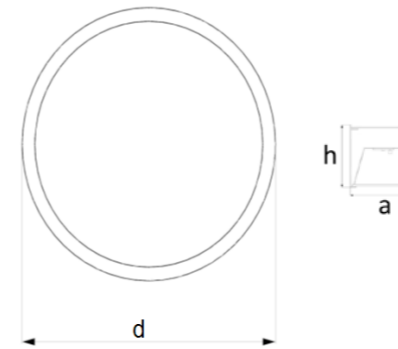

V / Hz 220 - 240 / 50 - 60

Opsiyonlar	Options	Options
DİM edilebilir konvertör. Acil durum kiti.	Dimmable convertor. Emergency kit for models.	Convertisseur dimmable Kit d'urgence.

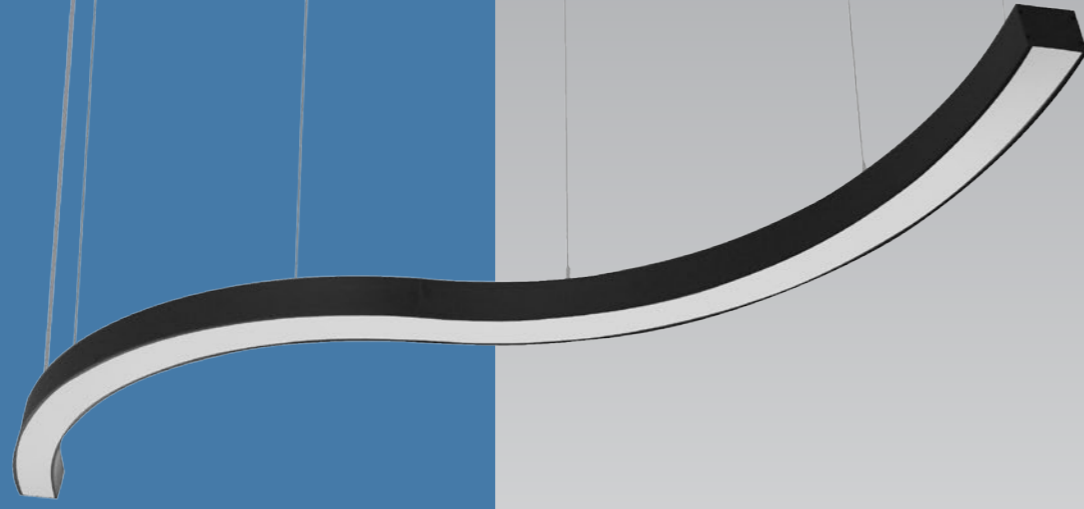

GALAKSİ S

Renk Seçenekleri
Color Options
Options de Couleur



LED

Sarkıt Buzlu Akrilik Difüzörlü Aydınlatma Armatürleri

Suspended Lighting Fixtures With Frosted Acrylic Diffuser

Luminaire Suspendus Avec Diffuseur Acrylique Givré

UYGULAMA ALANLARI

Alışveriş Merkezleri
Marketler
Ofisler
Toplantı Odaları
Mağazalar
Hastaneler
Okullar
Koridorlar

APPLICATION AREAS

Shopping Malls
Supermarkets
Offices
Meeting rooms
Stores
Hospitals
Schools
Corridors

DOMAINES D'UTILISATION

Centres Commerciaux
Supermarchés
Bureaux
Salles de Réunions
Magasins
Hopitaux
Ecoles
Couloirs

GÖVDE

Beyaz, ve siyah renk seçenekleri ile zarif tasarıma sahip alüminyum.

DİFÜZÖR

UV korumalı akrilik difüzör.

KONVERTÖR

ENEC standartlarına uygun, uzun ömürlü sabit akımlı konvertör.

LED

50.000 saat ömürlü LUMILEDS / OSRAM / SEOUL marka LED'li LED modüller.

ASKI

1mm çelik örgü tel ve nikel kaplamalı pirinç parçalardan mamul, askı boyu ayarlanabilir, şeffaf elektrik kablosu ve tavana monte edilen estetik tasarıma sahip elektrik bağlantı kutusu ile birlikte.

BODY

Anodized aluminum with satin finishing. Black and white color options with elegant design.

DIFFUSER

UV stabilized acrylic diffuser.

CONVERTER

Long life, low power loss converter with constant current. Compatible with ENEC standards.

LED

LED modules with 50,000 hours lifetime LUMILEDS / OSRAM / SEOUL brand LEDs.

SUSPENSION

Composed of 1mm steel wire rope and nickel-plated brass components. Suspension height is adjustable. Supplied with transparent electric cord and ceiling mounted electrical junction box with aesthetic design.

CORPS

Corps en aluminium anodisé, satiné. Design élégant. Couleurs blanc, noir disponibles.

DIFFUSEUR

Diffuseur en acrylique. Anti UV.

CONVERTEUR

Convertisseur, conforme aux normes ENEC. Longue vie. Perte de puissance faible avec courant constant.

LED

Modules LED – Durée de vie 50.000 heures avec LED de marque LUMILEDS / OSRAM / SEOUL.

SYSTEME DE FIXATION

Composé d'un fil en acier de 1mm, de composants en laiton nickelés. Livré avec un cordon électrique transparent et une boîte de jonction électrique à fixer au plafond. Hauteur de fixation réglable.

LED'li Tip / LED Type / Type LED

Renk Geri Verim Indexi / Color Rendering Index / Indice de Rendu des Couleurs: (CRI): Ra>80

Kod Code	Güç Power Puissance (W)	LED Tipi LED Type Type De LED	LED Modül LED Module Module LED	Işık Akısı Lum. Flux Flux Lum. (lm)	Renk Sıcaklığı Color Temperature Température De Couleur (K)	Ölçüler Dimensions (mm)				Ağırlık Weight Poids (kg)	Ambalaj Adedi Packing Quantity Colisage	Adet/20" Konteyner Pcs./20" Conteneur	Resim No Drawing No Dessin No
						l	k	a	h				
PL8SS23L15C	6x6,7	5630 SMD	PCB	4740	3000 / 4000 / 6500	1580	335	79	73	3,9	1	850	1
PL8SS23L25C	6x12,3	5630 SMD	PCB	8700	3000 / 4000 / 6500	1580	335	79	73	3,9	1	850	1
PL8SS33L15C	9x6,7	5630 SMD	PCB	7110	3000 / 4000 / 6500	2350	335	79	73	5,7	1	665	2
PL8SS33L25C	9x12,3	5630 SMD	PCB	13050	3000 / 4000 / 6500	2350	335	79	73	5,9	1	665	2
PL8SS24L15C	8x6,7	5630 SMD	PCB	6320	3000 / 4000 / 6500	2065	415	79	73	5,1	1	575	1
PL8SS24L25C	8x12,3	5630 SMD	PCB	11600	3000 / 4000 / 6500	2065	415	79	73	5,3	1	575	1
PL8SS34L15C	12x6,7	5630 SMD	PCB	9480	3000 / 4000 / 6500	3095	415	79	73	7,7	1	455	2
PL8SS34L25C	12x12,3	5630 SMD	PCB	17400	3000 / 4000 / 6500	3095	415	79	73	7,9	1	455	2
PL8SS25L15C	10x6,7	5630 SMD	PCB	7900	3000 / 4000 / 6500	2620	555	79	73	6,3	1	415	1
PL8SS25L25C	10x12,3	5630 SMD	PCB	14500	3000 / 4000 / 6500	2620	555	79	73	6,5	1	415	1
PL8SS35L15C	15x6,7	5630 SMD	PCB	11850	3000 / 4000 / 6500	3905	555	79	73	9,5	1	340	2
PL8SS35L25C	15x12,3	5630 SMD	PCB	21750	3000 / 4000 / 6500	3905	555	79	73	9,7	1	340	2
PL8SS26L15C	12x6,7	5630 SMD	PCB	9480	3000 / 4000 / 6500	3135	650	79	73	7,7	1	320	1
PL8SS26L25C	12x12,3	5630 SMD	PCB	17400	3000 / 4000 / 6500	3135	650	79	73	7,9	1	320	1
PL8SS36L15C	18x6,7	5630 SMD	PCB	14220	3000 / 4000 / 6500	4670	715	79	73	11,3	1	265	2
PL8SS36L25C	18x12,3	5630 SMD	PCB	26100	3000 / 4000 / 6500	4670	715	79	73	11,5	1	265	2

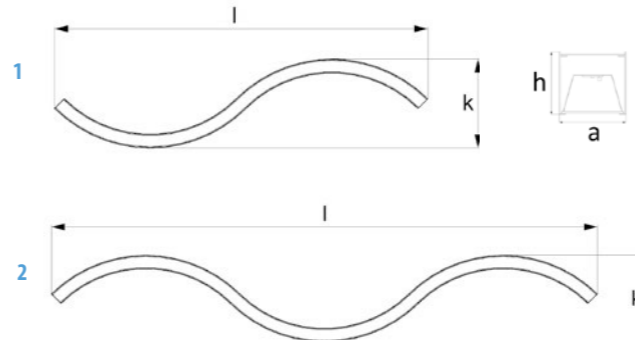

V / Hz 220 - 240 / 50 - 60

Opsiyonlar	Options	Options
DIM edilebilir konvertör.	Dimmable converter.	Convertisseur dimmable.
Acil durum kiti.	Emergency kit.	Kit d'urgence.



GALAKSİ OVAL

Renk Seçenekleri
Color Options
Options de Couleur



LED

Sarkıt Buzlu Akrilik Difüzörlü Aydınlatma Armatürleri

Suspended Lighting Fixtures With Frosted Acrylic Diffuser

Luminaire Suspendus Avec Diffuseur Acrylique Givré

UYGULAMA ALANLARI

Alışveriş Merkezleri
Marketler
Ofisler
Toplantı Odaları
Oturma Odaları
Bekleme Salonları
Mağazalar
Hastaneler
Okullar
Koridorlar

APPLICATION AREAS

Shopping Malls
Supermarkets
Offices
Meeting rooms
Living Rooms
Waiting Rooms
Stores
Hospitals
Schools
Corridors

DOMAINES D'UTILISATION

Centres Commerciaux
Supermarchés
Bureaux
Salles de Réunions
Salles de Séjour
Salles D'attente
Magasins
Hopitaux
Ecoles
Couloirs

GÖVDE

Beyaz, siyah, yeşil, turuncu, sarı renk seçenekleri ile zarif tasarıma sahip alüminyum.

DİFÜZÖR

UV korumalı akrilik difüzör.

KONVERTÖR

ENEC standartlarına uygun, uzun ömürlü sabit akımlı konvertör.

LED

50.000 saat ömürlü LUMILEDS / OSRAM / SEOUL marka LED'li LED modüller.

ASKI

1mm çelik örgü tel ve nikel kaplamalı pirinç parçalardan mamul, askı boyu ayarlanabilir, şeffaf elektrik kablosu ve tavana monte edilen estetik tasarıma sahip elektrik bağlantı kutusu ile birlikte.

BODY

Anodized aluminum with satin finishing. White, black, green, orange, yellow color options with elegant design.

DIFFUSEUR

UV stabilized acrylic diffuser.

CONVERTER

Long life, low power loss converter with constant current. Compatible with ENEC standards.

LED

LED modules with 50,000 hours lifetime LUMILEDS / OSRAM / SEOUL brand LEDs.

SUSPENSION

Composed of 1mm steel wire rope and nickel-plated brass components. Suspension height is adjustable. Supplied with transparent electric cord and ceiling mounted electrical junction box with aesthetic design.

CORPS

Corps en aluminium anodisé, satiné. Design élégant. Couleurs blanc, noir, vert, orange, jaune disponibles.

DIFFUSEUR

Diffuseur en acrylique. Anti UV.

CONVERTEUR

Convertisseur, conforme aux normes ENEC. Longue vie. Perte de puissance faible avec courant constant.

LED

Modules LED – Durée de vie 50.000 heures avec LED de marque LUMILEDS / OSRAM / SEOUL.

SYSTEME DE FIXATION

Composé d'un fil en acier de 1mm, de composants en laiton nickelés. Livré avec un cordon électrique transparent et une boîte de jonction électrique à fixer au plafond. Hauteur de fixation réglable.

LED'li Tip / LED Type / Type LED

Renk Geri Verim Indexi / Color Rendering Index / Indice de Rendu des Couleurs: (CRI): Ra>80

Kod Code	Güç Power Puissance (W)	LED Tipi LED Type Type De LED	LED Modül LED Module Module LED	Işık Akısı Lum. Flux Flux Lum. (lm)	Renk Sıcaklığı Color Temperature Température De Couleur (K)	Ölçüler Dimensions (mm) a b h	Ağırlık Weight Poids (kg)	Ambalaj Adedi Packing Quantity Colisage	Adet/20" Konteyner Pcs./20" Conteneur
PL8SV12L15C	6x6,7	5630 SMD	PCB	4740	3000 / 4000 / 6500	675 470 73	3.8	1	820
PL8SV12L25C	6x12,3	5630 SMD	PCB	8700	3000 / 4000 / 6500	675 470 73	3.9	1	820
PL8SV24L15C	12x6,7	5630 SMD	PCB	9480	3000 / 4000 / 6500	1275 825 73	7.7	1	260
PL8SV24L25C	12x12,3	5630 SMD	PCB	17400	3000 / 4000 / 6500	1275 825 73	7.9	1	260

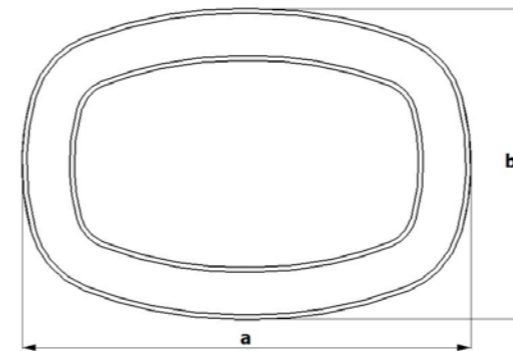

V / Hz 220 - 240 / 50 - 60

Opsiyonlar	Options	Options
DIM edilebilir konvertör.	Dimmable converter.	Convertisseur dimmable.
Acil durum kit.	Emergency kit.	Kit d'urgence.

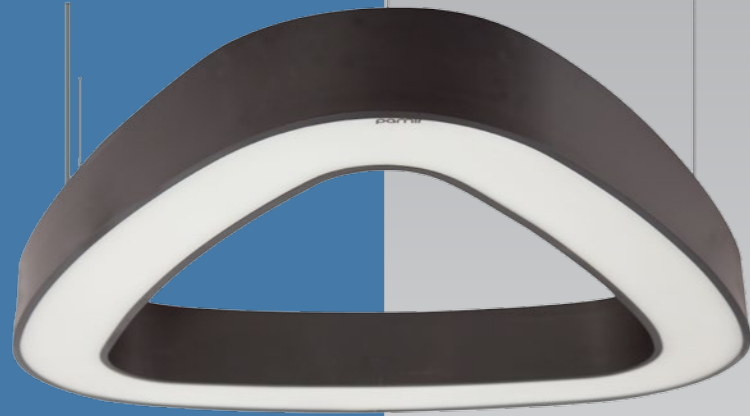

GALAKSİ TRILINE

Renk Seçenekleri
Color Options
Options de Couleur



LED

Sarkıt Buzlu Akrilik Difüzörlü
Aydınlatma Armatürleri

Suspended Lighting Fixtures With
Frosted Acrylic Diffuser

Luminares Suspendus Avec
Diffuseur Acrylique Givré

UYGULAMA ALANLARI

Alışveriş Merkezleri
Marketler
Ofisler
Toplantı Odaları
Oturma Odaları
Bekleme Salonları
Mağazalar
Hastaneler
Okullar
Koridorlar

APPLICATION AREAS

Shopping Malls
Supermarkets
Offices
Meeting rooms
Living Rooms
Waiting Rooms
Stores
Hospitals
Schools
Corridors

DOMAINES D'UTILISATION

Centres Commerciaux
Supermarchés
Bureaux
Salles de Réunions
Salles de Séjour
Salles D'attente
Magasins
Hopitaux
Ecoles
Coulloirs

GÖVDE

Beyaz, siyah, yeşil, turuncu, sarı renk seçenekleri ile zarif tasarıma sahip alüminyum.

DİFÜZÖR

UV korumalı akrilik difüzör.

KONVERTÖR

ENEC standartlarına uygun, uzun ömürlü sabit akımlı konvertör.

LED

50.000 saat ömürlü LUMILEDS / OSRAM / SEOUL marka LED'li LED modüller.

ASKI

1mm çelik örgü tel ve nikel kaplamalı pirinç parçalardan mamul, askı boyu ayarlanabilir, şeffaf elektrik kablosu ve tavana monte edilen estetik tasarıma sahip elektrik bağlantı kutusu ile birlikte.

BODY

Anodized aluminum with satin finishing. White, black, green, orange, yellow color options with elegant design.

DIFFUSEUR

UV stabilized acrylic diffuser.

CONVERTER

Long life, low power loss converter with constant current. Compatible with ENEC standards.

LED

LED modules with 50,000 hours lifetime LUMILEDS / OSRAM / SEOUL brand LEDs.

SUSPENSION

Composed of 1mm steel wire rope and nickel-plated brass components. Suspension height is adjustable. Supplied with transparent electric cord and ceiling mounted electrical junction box with aesthetic design.

CORPS

Corps en aluminium anodisé, satiné. Design élégant. Couleurs blanc, noir, vert, orange, jaune disponibles.

DIFFUSEUR

Diffuseur en acrylique. Anti UV.

CONVERTEUR

Convertisseur, conforme aux normes ENEC. Longue vie. Perte de puissance faible avec courant constant.

LED

Modules LED – Durée de vie 50.000 heures avec LED de marque LUMILEDS / OSRAM / SEOUL.

SYSTEME DE FIXATION

Composé d'un fil en acier de 1mm, de composants en laiton nickelés. Livré avec un cordon électrique transparent et une boîte de jonction électrique à fixer au plafond. Hauteur de fixation réglable.

LED'li Tip / LED Type / Type LED

Renk Geri Verim Indexi / Color Rendering Index / Indice de Rendu des Couleurs: (CRI): Ra>80

Kod Code	Güç Power Puissance (W)	LED Tipi LED Type Type De LED	LED Modül LED Module Module LED	Işık Akısı Lum. Flux Flux Lum. (lm)	Renk Sıcaklığı Color Temperature Température De Couleur (K)	Ölçüler Dimensions (mm) a h	Ağırlık Weight Poids (kg)	Ambalaj Adedi Packing Quantity Colisage	Adet/20" Konteyner Pcs./20" Conteneur
PL8ST6L15C	6x6,7	5630 SMD	PCB	4740	3000 / 4000 / 6500	595 73	4.2	1	710
PL8ST6L25C	6x12,3	5630 SMD	PCB	8700	3000 / 4000 / 6500	595 73	4.3	1	710
PL8ST9L15C	9x6,7	5630 SMD	PCB	7110	3000 / 4000 / 6500	890 73	6.1	1	340
PL8ST9L25C	9x12,3	5630 SMD	PCB	13050	3000 / 4000 / 6500	890 73	6.3	1	340
PL8ST12L15C	12x6,7	5630 SMD	PCB	9480	3000 / 4000 / 6500	1160 73	8.1	1	200
PL8ST12L25C	12x12,3	5630 SMD	PCB	17400	3000 / 4000 / 6500	1160 73	8.3	1	200

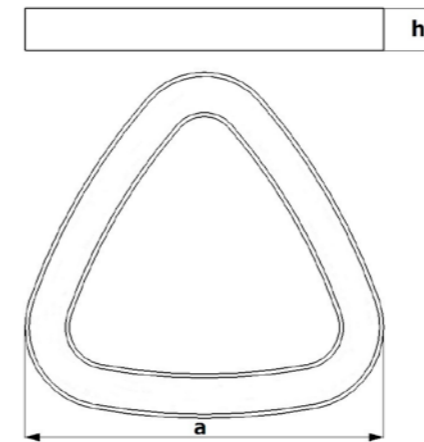

V / Hz 220 - 240 / 50 - 60

Opsiyonlar	Options	Options
DIM edilebilir konvertör.	Dimmable converter.	Convertisseur dimmable.
Acil durum kiti.	Emergency kit.	Kit d'urgence.



GALAKSİ TRIO

Renk Seçenekleri
Color Options
Options de Couleur



LED

Sarkıt Buzlu Akrilik Difüzörlü
Aydınlatma Armatürleri

Suspended Lighting Fixtures With
Frosted Acrylic Diffuser

Luminaire Suspendus Avec
Diffuseur Acrylique Givré

UYGULAMA ALANLARI

Alışveriş Merkezleri
Marketler
Ofisler
Toplantı Odaları
Oturma Odaları
Bekleme Salonları
Mağazalar
Hastaneler
Okullar
Koridorlar

APPLICATION AREAS

Shopping Malls
Supermarkets
Offices
Meeting rooms
Living Rooms
Waiting Rooms
Stores
Hospitals
Schools
Corridors

DOMAINES D'UTILISATION

Centres Commerciaux
Supermarchés
Bureaux
Salles de Réunions
Salles de Séjour
Salles D'attente
Magasins
Hopitaux
Ecoles
Couloirs

LED'li Tip / LED Type / Type LED

Renk Geri Verim Indexi / Color Rendering Index / Indice de Rendu des Couleurs: (CRI): Ra>80

Kod Code	Güç Power Puissance (W)	LED Tipi LED Type Type De LED	LED Modül LED Module Module LED	Işık Akısı Lum. Flux Flux Lum. (lm)	Renk Sıcaklığı Color Temperature Température De Couleur (K)	Ölçüler Dimensions (mm) a h	Ağırlık Weight Poids (kg)	Ambalaj Adedi Packing Quantity Colisage	Adet/20" Konteyner Pcs./20" Conteneur
PL8SU45U15C	45	3535 SMD	PCB	6150	3000 / 4000 / 6500	445 73	4.3	1	1200

GÖVDE

Beyaz, siyah, yeşil, turuncu, sarı renk seçenekleri ile zarif tasarıma sahip alüminyum.

DİFÜZÖR

UV korumalı akrilik difüzör.

KONVERTÖR

ENEC standartlarına uygun, uzun ömürlü sabit akımlı konvertör.

LED

50.000 saat ömürlü LUMILEDS / OSRAM / SEOUL marka LED'li LED modüller.

ASKI

1mm çelik örgü tel ve nikel kaplamalı pirinç parçalardan mamul, askı boyu ayarlanabilir, şeffaf elektrik kablosu ve tavana monte edilen estetik tasarıma sahip elektrik bağlantı kutusu ile birlikte.

BODY

Anodized aluminum with satin finishing. White, black, green, orange, yellow color options with elegant design.

DIFFUSER

UV stabilized acrylic diffuser.

CONVERTER

Long life, low power loss converter with constant current. Compatible with ENEC standards.

LED

LED modules with 50,000 hours lifetime LUMILEDS / OSRAM / SEOUL brand LEDs.

SUSPENSION

Composed of 1mm steel wire rope and nickel-plated brass components. Suspension height is adjustable. Supplied with transparent electric cord and ceiling mounted electrical junction box with aesthetic design.

CORPS

Corps en aluminium anodisé, satiné. Design élégant. Couleurs blanc, noir, vert, orange, jaune disponibles.

DIFFUSEUR

Diffuseur en acrylique. Anti UV.

CONVERTEUR

Convertisseur, conforme aux normes ENEC. Longue vie. Perte de puissance faible avec courant constant.

LED

Modules LED – Durée de vie 50.000 heures avec LED de marque LUMILEDS / OSRAM / SEOUL.

SYSTEME DE FIXATION

Composé d'un fil en acier de 1mm, de composants en laiton nickelés. Livré avec un cordon électrique transparent et une boîte de jonction électrique à fixer au plafond. Hauteur de fixation réglable.

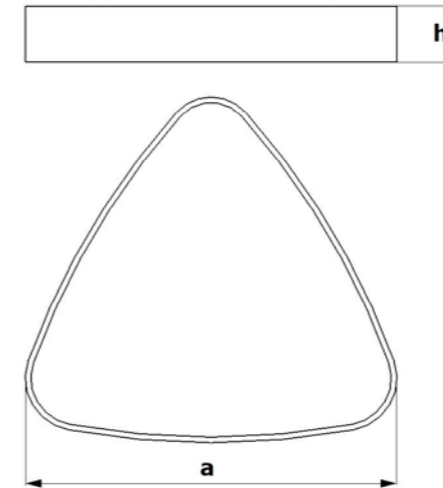

V / Hz 220 - 240 / 50 - 60

Opsiyonlar	Options	Options
DIM edilebilir konvertör.	Dimmable converter.	Convertisseur dimmable.
Acil durum kit.	Emergency kit.	Kit d'urgence.

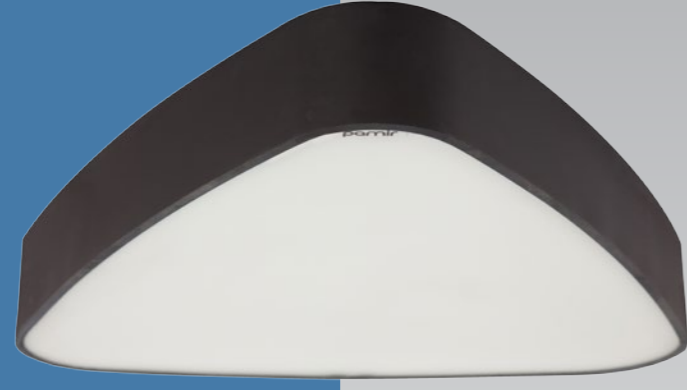

GALAKSİ TRIO

Renk Seçenekleri
Color Options
Options de Couleur



LED

Sıva Üstü Buzlu Akrilik Difüzörlü Aydınlatma Armatürleri

Surface Mounted Lighting Fixtures With Frosted Acrylic Diffuser

Luminaires Apparents Avec Diffuseur Acrylique Givré

UYGULAMA ALANLARI

Alışveriş Merkezleri
Marketler
Ofisler
Toplantı Odaları
Oturma Odaları
Bekleme Salonları
Mağazalar
Hastaneler
Okullar
Koridorlar

APPLICATION AREAS

Shopping Malls
Supermarkets
Offices
Meeting rooms
Living Rooms
Waiting Rooms
Stores
Hospitals
Schools
Corridors

DOMAINES D'UTILISATION

Centres Commerciaux
Supermarchés
Bureaux
Salles de Réunions
Salles de Séjour
Salles D'attente
Magasins
Hopitaux
Ecoles
Couloirs

GÖVDE

Beyaz, siyah, yeşil, turuncu, sarı renk seçenekleri ile zarif tasarıma sahip alüminyum.

DİFÜZÖR

UV korumalı akrilik difüzör.

KONVERTÖR

ENEC standartlarına uygun, uzun ömürlü sabit akımlı konvertör.

LED

50.000 saat ömürlü LUMILEDS / OSRAM / SEOUL marka LED'li LED modüller.

BODY

Anodized aluminum with satin finishing. White, black, green, orange, yellow color options with elegant design.

DIFFUSEUR

UV stabilized acrylic diffuser.

CONVERTER

Long life, low power loss converter with constant current. Compatible with ENEC standards.

LED

LED modules with 50,000 hours lifetime LUMILEDS / OSRAM / SEOUL brand LEDs.

CORPS

Corps en aluminium anodisé, satiné. Design élégant. Couleurs blanc, noir, vert, orange, jaune disponibles.

DIFFUSEUR

Diffuseur en acrylique. Anti UV.

CONVERTEUR

Convertisseur, conforme aux normes ENEC. Longue vie. Perte de puissance faible avec courant constant.

LED

Modules LED – Durée de vie 50.000 heures avec LED de marque LUMILEDS / OSRAM / SEOUL.

LED'li Tip / LED Type / Type LED

Renk Geri Verim Indexi / Color Rendering Index / Indice de Rendu des Couleurs: (CRI): Ra>80

Kod Code	Güç Power Puissance (W)	LED Tipi LED Type Type De LED	LED Modül LED Module Module LED	Işık Akısı Lum. Flux Flux Lum. (lm)	Renk Sıcaklığı Color Temperature Température De Couleur (K)	Ölçüler Dimensions (mm) a h	Ağırlık Weight Poids (kg)	Ambalaj Adedi Packing Quantity Colisage	Adet/20" Konteyner Pcs./20" Conteneur
PL8UU45U15C	45	3535 SMD	PCB	6150	3000 / 4000 / 6500	445 97	4.1	1	860

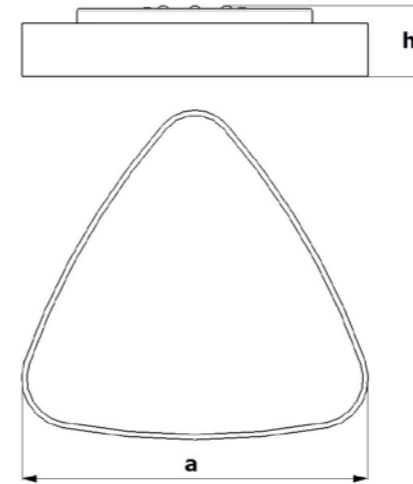

V / Hz 220 - 240 / 50 - 60

Opsiyonlar	Options	Options
DIM edilebilir konvertör.	Dimmable converter.	Convertisseur dimmable.
Acil durum kiti.	Emergency kit.	Kit d'urgence.



GALAKSİ DOLUNAY

Renk Seçenekleri
Color Options
Options de Couleur



LED

Sarkıt Buzlu Akrilik Difüzörlü
Aydınlatma Armatürleri

Suspended Lighting Fixtures With
Frosted Acrylic Diffuser

Luminaire Suspendus Avec
Diffuseur Acrylique Givré

UYGULAMA ALANLARI

Alışveriş Merkezleri
Marketler
Ofisler
Toplantı Odaları
Oturma Odaları
Bekleme Salonları
Mağazalar
Hastaneler
Okullar
Koridorlar

APPLICATION AREAS

Shopping Malls
Supermarkets
Offices
Meeting rooms
Living Rooms
Waiting Rooms
Stores
Hospitals
Schools
Corridors

DOMAINES D'UTILISATION

Centres Commerciaux
Supermarchés
Bureaux
Salles de Réunions
Salles de Séjour
Salles D'attente
Magasins
Hopitaux
Ecoles
Coulloirs

GÖVDE

Beyaz, siyah, yeşil, turuncu, sarı seçenekleri ile zarif tasarıma sahip alüminyum.

DİFÜZÖR

UV korumalı akrilik difüzör.

KONVERTÖR

ENEC standartlarına uygun, uzun ömürlü sabit akımlı konvertör.

LED

50.000 saat ömürlü LUMILEDS / OSRAM / SEOUL marka LED'li LED modüller.

ASKI

1mm çelik örgü tel ve nikel kaplamalı pirinç parçalardan mamul, askı boyu ayarlanabilir, şeffaf elektrik kablosu ve tavana monte edilen estetik tasarıma sahip elektrik bağlantı kutusu ile birlikte.

BODY

Anodized aluminum with satin finishing. White, black, green, orange, yellow color options with elegant design.

DIFFUSER

UV stabilized acrylic diffuser.

CONVERTER

Long life, low power loss converter with constant current. Compatible with ENEC standards.

LED

LED modules with 50,000 hours lifetime LUMILEDS / OSRAM / SEOUL brand LEDs.

SUSPENSION

Composed of 1mm steel wire rope and nickel-plated brass components. Suspension height is adjustable. Supplied with transparent electric cord and ceiling mounted electrical junction box with aesthetic design.

CORPS

Corps en aluminium anodisé, satiné. Design élégant. Couleurs blanc, noir, vert, orange, jaune disponibles.

DIFFUSEUR

Diffuseur en acrylique. Anti UV.

CONVERTEUR

Convertisseur, conforme aux normes ENEC. Longue vie. Perte de puissance faible avec courant constant.

LED

Modules LED – Durée de vie 50.000 heures avec LED de marque LUMILEDS / OSRAM / SEOUL.

SYSTEME DE FIXATION

Composé d'un fil en acier de 1mm, de composants en laiton nickelés. Livré avec un cordon électrique transparent et une boîte de jonction électrique à fixer au plafond. Hauteur de fixation réglable.

LED'li Tip / LED Type / Type LED

Renk Geri Verim Indexi / Color Rendering Index / Indice de Rendu des Couleurs: (CRI): Ra>80

Kod Code	Güç Power Puissance (W)	LED Tipi LED Type Type De LED	LED Modül LED Module Module LED	Işık Akısı Lum. Flux Flux Lum. (lm)	Renk Sıcaklığı Color Temperature Température De Couleur (K)	Ölçüler Dimensions (mm) d h	Ağırlık Weight Poids (kg)	Ambalaj Adedi Packing Quantity Colisage	Adet/20" Konteyner Pcs./20" Container Pcs./20" Conteneur
PL8SD52Y15C	52	3535 SMD	PCB	7150	3000 / 4000 / 6500	465 73	5.2	1	1160

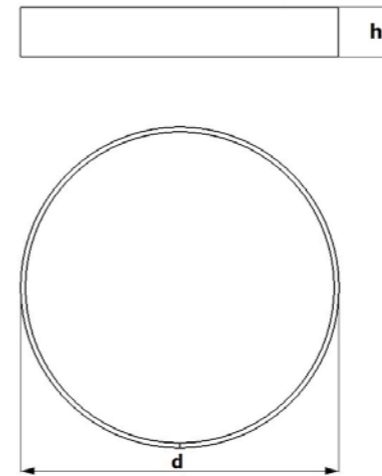

V / Hz 220 - 240 / 50 - 60

Opsiyonlar	Options	Options
DİM edilebilir konvertör.	Dimmable converter.	Convertisseur dimmable.
Acil durum kit.	Emergency kit.	Kit d'urgence.



GALAKSİ DOLUNAY

Renk Seçenekleri
Color Options
Options de Couleur



LED

Sıva Üstü Buzlu Akrilik Difüzörlü
Aydınlatma Armatürleri

Surface Mounted Lighting Fixtures
With Frosted Acrylic Diffuser

Luminaire Apparents Avec
Diffuseur Acrylique Givré

UYGULAMA ALANLARI

Alışveriş Merkezleri
Marketler
Ofisler
Toplantı Odaları
Oturma Odaları
Bekleme Salonları
Mağazalar
Hastaneler
Okullar
Koridorlar

APPLICATION AREAS

Shopping Malls
Supermarkets
Offices
Meeting rooms
Living Rooms
Waiting Rooms
Stores
Hospitals
Schools
Corridors

DOMAINES D'UTILISATION

Centres Commerciaux
Supermarchés
Bureaux
Salles de Réunions
Salles de Séjour
Salles D'attente
Magasins
Hopitaux
Ecoles
Couloirs

GÖVDE

Beyaz, siyah, yeşil, turuncu, sarı renk seçenekleri ile zarif tasarıma sahip alüminyum.

DİFÜZÖR

UV korumalı akrilik difüzör.

KONVERTÖR

ENEC standartlarına uygun, uzun ömürlü sabit akımlı konvertör.

LED

50.000 saat ömürlü LUMILEDS / OSRAM / SEOUL marka LED'li LED modüller.

BODY

Anodized aluminum with satin finishing. Black, white and silver color options with elegant design.

DIFFUSER

UV stabilized acrylic diffuser.

CONVERTER

Long life, low power loss converter with constant current. Compatible with ENEC standards.

LED

LED modules with 50,000 hours lifetime LUMILEDS / OSRAM / SEOUL brand LEDs.

CORPS

Corps en aluminium anodisé, satiné. Design élégant. Couleurs blanc, noir, vert, orange, jaune disponibles.

DIFFUSEUR

Diffuseur en acrylique. Anti UV.

CONVERTEUR

Convertisseur, conforme aux normes ENEC. Longue vie. Perte de puissance faible avec courant constant.

LED

Modules LED – Durée de vie 50.000 heures avec LED de marque LUMILEDS / OSRAM / SEOUL.

LED'li Tip / LED Type / Type LED

Renk Geri Verim Indexi / Color Rendering Index / Indice de Rendu des Couleurs: (CRI): Ra>80

Kod Code	Güç Power Puissance (W)	LED Tipi LED Type Type De LED	LED Modül LED Module Module LED	Işık Akısı Lum. Flux Flux Lum. (lm)	Renk Sıcaklığı Color Temperature Température De Couleur (K)	Ölçüler Dimensions (mm) d h	Ağırlık Weight Poids (kg)	Ambalaj Adedi Packing Quantity Colisage	Adet/20" Konteyner Pcs./20" Conteneur
PL8UD52Y15C	52	3535 SMD	PCB	7150	3000 / 4000 / 6500	465 97	5.0	1	830

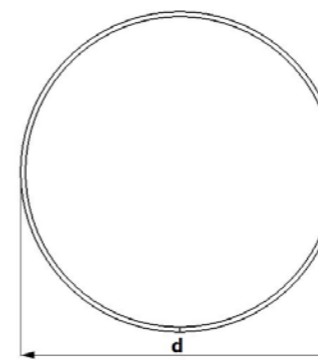

V / Hz 220 - 240 / 50 - 60

Opsiyonlar	Options	Options
DIM edilebilir konvertör.	Dimmable converter.	Convertisseur dimmable.
Acil durum kiti.	Emergency kit.	Kit d'urgence.



PRİZMA

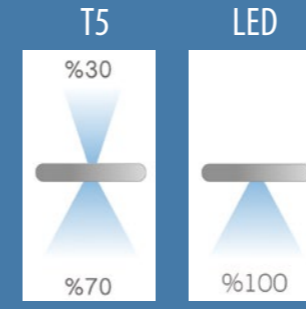

Renk Seçenekleri
Color Options
Options de Couleur



LED / T16 (T5)

Sarkıt 2X Buzlu Difüzörlü
Aydınlatma Armatürleri

Suspended 2X Lighting
Fixtures With Frosted Diffuser

Luminaire Suspendus 2X Avec
Diffuseur Givré

UYGULAMA ALANLARI

Ofisler
Toplantı Odaları
Mağazalar
Hastaneler
Okullar
Koridorlar

APPLICATION AREAS

Offices
Meeting rooms
Stores
Hospitals
Schools
Corridors

DOMAINES D'UTILISATION

Bureaux
Salles de Réunion
Magasins
Hopitaux
Ecoles
Coulors

GÖVDE

Beyaz, gümüş, siyah renk seçenekleri ile ince (32mm) zarif tasarıma sahip alüminyum.

DİFÜZÖR

UV korumalı buzlu difüzör.

BALAST (T5 Modeller için)

ENEC standartlarına uygun, uzun ömürlü sabit ışık akısına sahip, düşük enerji kayıplı (EEI=A2) elektronik balast.

KONVERTÖR (LED'li Modeller için)

ENEC standartlarına uygun, uzun ömürlü sabit akımlı konvertör.

LED (LED'li Modeller için)

50.000 saat ömürlü LUMILEDS / OSRAM / SEOUL marka LED'li LED modüller.

ASKI

1mm çelik örgü tel ve nikel kaplamalı pirinç parçalardan mamul, askı boyu ayarlanabilir, şeffaf elektrik kablosu ve tavana monte edilen estetik tasarıma sahip elektrik bağlantı kutusu ile birlikte.

BODY

Anodized aluminum with satin finishing. Black, white and silver color options with thin (32mm) elegant design.

DIFFUSEUR

UV stabilized frosted diffuser.

BALLAST (For T5 Models)

Electronic ballast with long life, low power loss EEI = A2 and constant flux. Compatible with ENEC standards.

CONVERTER (For LED Models)

Long life, low power loss converter with constant current. Compatible with ENEC standards.

LED (For LED Models)

LED modules with 50,000 hours lifetime LU-MILEDS / OSRAM / SEOUL brand LEDs.

SUSPENSION

Composed of 1mm steel wire rope and nickel plated brass components. Suspension height is adjustable. Supplied with transparent electric cord and ceiling mounted electrical junction box with aesthetic design.

CORPS

Corps en aluminium anodisé, satiné. Design élégant. Couleurs blanc, argent et noir disponibles. Epaisseur 32 mm.

DIFFUSEUR

Diffuseur givré. Anti UV.

BALLAST (Pour T5 Modèles)

Ballast électronique, conforme aux normes ENEC. Longue vie. Perte de puissance faible (EEI = A2). Flux de lumière régulier.

CONVERTEUR (Pour Modèles LED)

Convertisseur, conforme aux normes ENEC. Longue vie. Perte de puissance faible avec courant constant.

LED (Pour Modèles LED)

Modules LED – Durée de vie 50.000 heures avec LED de marque LUMILEDS / OSRAM / SEOUL.

SYSTEME DE FIXATION

Composé d'un fil en acier de 1mm, de composants en laiton nickelés. Livré avec un cordon électrique transparent et une boîte de jonction électrique à fixer au plafond. Hauteur de fixation réglable.

LED'li Tip / LED Type / Type LED

Renk Geri Verim Indexi / Color Rendering Index / Indice de Rendu des Couleurs: (CRI): Ra>80

Kod Code	Güç Power Puissance (W)	LED Tipi LED Type Type De LED	LED Modül LED Module Module LED	Işık Akısı Lum. Flux Flux Lum. (lm)	Renk Sıcaklığı Color Temperature Température De Couleur (K)	Ölçüler Dimensions (mm)			Ağırlık Weight Poids (kg)	Ambalaj Adedi Packing Quantity Colisage	Adet/20" Konteyner Pcs./20" Container Pcs./20" Conteneur
						a	b	h			
PL4S22L15C	4x6,5	3535 SMD	PCB	3400	3000 / 4000 / 6500	222	645	32	2.6	2	2610
PL4S23L15C	6x6,5	3535 SMD	PCB	5100	3000 / 4000 / 6500	222	925	32	3.3	2	1930
PL4S24L15C	8x6,5	3535 SMD	PCB	6800	3000 / 4000 / 6500	222	1206	32	4.0	2	1520
PL4S25L15C	10x6,5	3535 SMD	PCB	8500	3000 / 4000 / 6500	222	1486	32	4.8	2	1270

T5 Floresanlı Tip / T5 Fluorescent Type / Type T5 Fluorescent

Kod Code	Güç Power Puissance (W)	Ampul Tipi Lamp Type Typ. De Lamp.	Duy Tipi Socket Type Type De Douille	Işık Akısı Lum. Flux Flux Lum. (lm)	Akım Current Courant (A)	Ölçüler Dimensions (mm)			Ağırlık Weight Poids (kg)	Ambalaj Adedi Packing Quantity Colisage	Adet/20" Konteyner Pcs./20" Container Pcs./20" Conteneur
						a	b	h			
P54S214C	2x14	T16(T5)	G5	2400	0.14	222	593	32	2.40	2	2840
P54S224C	2x24	T16(T5)	G5	3500	0.23	222	593	32	2.40	2	2840
P54S221C	2x21	T16(T5)	G5	3800	0.20	222	893	32	3.20	2	2000
P54S228C	2x28	T16(T5)	G5	5200	0.26	222	1193	32	4.00	2	1540
P54S254C	2x54	T16(T5)	G5	8900	0.50	222	1193	32	4.00	2	1540
P54S235C	2x35	T16(T5)	G5	6600	0.33	222	1493	32	4.80	2	1260
P54S249C	2x49	T16(T5)	G5	8600	0.49	222	1493	32	4.80	2	1260
P54S280C	2x80	T16(T5)	G5	12300	0.76	222	1493	32	4.80	2	1260

V / Hz 220 - 240 / 50 - 60

Opsiyonlar	Options	Options
DIM edilebilir elektronik balast yada konvertör. LED'li modeller için acil durum kit.	Dimmable electronic ballast or convertor. Emergency kit for models with LED	Ballast électronique dimmable ou converteur. Kit d'urgence pour les modèles LED.

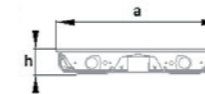

PRİZMA

Renk Seçenekleri
Color Options
Options de Couleur



LED / T16 (T5)

Sıva Üstü 2X Buzlu Difüzörlü
Aydınlatma Armatürleri

Surface Mounted 2X Lighting
Fixtures With Frosted Diffuser

Luminaire Apparents 2X Avec
Diffuseur Givré

UYGULAMA ALANLARI

Ofisler
Toplantı Odaları
Mağazalar
Hastaneler
Okullar
Koridorlar

APPLICATION AREAS

Offices
Meeting rooms
Stores
Hospitals
Schools
Corridors

DOMAINES D'UTILISATION

Bureaux
Salles de Réunion
Magasins
Hopitaux
Ecoles
Coulors

GÖVDE

Beyaz, gümüş, siyah renk seçenekleri ile ince (32mm) zarif tasarıma sahip alüminyum.

DİFÜZÖR

UV korumalı buzlu difüzör.

BALAST (T5 Modeller İçin)

ENEC standartlarına uygun, uzun ömürlü sabit ışık akısına sahip, düşük enerji kayıplı (EEI=A2) elektronik balast.

KONVERTÖR (LED'li Modeller İçin)

ENEC standartlarına uygun, uzun ömürlü sabit akımlı konvertör.

LED (LED'li Modeller İçin)

50.000 saat ömürlü LUMILEDS / OSRAM / SEOUL marka LED'li LED modüller.

BODY

Anodized aluminum with satin finishing. Black, white and silver color options with thin (32mm) elegant design.

DIFFUSER

UV stabilized frosted diffuser.

BALLAST (For T5 Models)

Electronic ballast with long life, low power loss EEI = A2 and constant flux. Compatible with ENEC standards.

CONVERTER (For LED Models)

Long life, low power loss converter with constant current. Compatible with ENEC standards.

LED (For LED Models)

LED modules with 50,000 hours lifetime LUMILEDS / OSRAM / SEOUL brand LEDs.

CORPS

Corps en aluminium anodisé, satiné. Design élégant. Couleurs blanc, argent et noir disponibles. Epaisseur 32 mm.

DIFFUSEUR

Diffuseur givré. Anti UV.

BALLAST (Pour T5 Modèles)

Ballast électronique, conforme aux normes ENEC. Longue vie. Perte de puissance faible (EEI = A2). Flux de lumière régulier.

CONVERTEUR (Pour Modèles LED)

Convertisseur, conforme aux normes ENEC. Longue vie. Perte de puissance faible avec courant constant.

LED (Pour Modèles LED)

Modules LED - Durée de vie 50.000 heures avec LED de marque LUMILEDS / OSRAM / SEOUL.

LED'li Tip / LED Type / Type LED

Renk Geri Verim Indexi / Color Rendering Index / Indice de Rendu des Couleurs: (CRI): Ra>80

Kod Code	Güç Power Puissance (W)	LED Tipi LED Type Type De LED	LED Modül LED Module Module LED	Işık Akısı Lum. Flux Flux Lum. (lm)	Renk Sıcaklığı Color Temperature Température De Couleur (K)	Ölçüler Dimensions (mm)			Ağırlık Weight Poids (kg)	Ambalaj Adedi Packing Quantity Colisage	Adet/20" Konteyner Pcs./20" Container Pcs./20" Conteneur
						a	b	h			
PL4U22L15C	4x6,5	3535 SMD	PCB	3400	3000 / 4000 / 6500	222	645	32	2.6	4	2610
PL4U23L15C	6x6,5	3535 SMD	PCB	5100	3000 / 4000 / 6500	222	925	32	3.3	2	1930
PL4U24L15C	8x6,5	3535 SMD	PCB	6800	3000 / 4000 / 6500	222	1206	32	4.0	2	1520
PL4U25L15C	10x6,5	3535 SMD	PCB	8500	3000 / 4000 / 6500	222	1486	32	4.8	2	1270

T5 Floresanlı Tip / T5 Fluorescent Type / Type T5 Fluorescent

Kod Code	Güç Power Puissance (W)	Ampul Tipi Lamp Type Type De Lampe	Duy Tipi Socket Type Type De Douille	Işık Akısı Lum. Flux Flux Lum. (lm)	Akım Current Courant (A)	Ölçüler Dimensions (mm)			Ağırlık Weight Poids (kg)	Ambalaj Adedi Packing Quantity Colisage	Adet/20" Konteyner Pcs./20" Container Pcs./20" Conteneur
						a	b	h			
P54U214C	2x14	T16(T5)	G5	2400	0.14	222	593	32	2.20	4	2680
P54U224C	2x24	T16(T5)	G5	3500	0.23	222	593	32	2.20	4	2680
P54U221C	2x21	T16(T5)	G5	3800	0.20	222	893	32	3.00	2	1920
P54U228C	2x28	T16(T5)	G5	5200	0.26	222	1193	32	3.80	2	1500
P54U254C	2x54	T16(T5)	G5	8900	0.50	222	1193	32	3.80	2	1500
P54U235C	2x35	T16(T5)	G5	6600	0.33	222	1493	32	4.60	2	1220
P54U249C	2x49	T16(T5)	G5	8600	0.49	222	1493	32	4.60	2	1220
P54U280C	2x80	T16(T5)	G5	12300	0.76	222	1493	32	4.60	2	1220

V / Hz 220 - 240 / 50 - 60

Opsiyonlar	Options	Options
DIM edilebilir elektronik balast yada konvertör.	Dimmable electronic ballast or convertor.	Ballast électronique dimmable ou converteur.
LED'li modeller için acil durum kit.	Emergency kit for models with LED	Kit d'urgence pour les modèles LED.

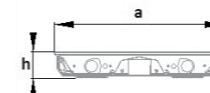



PRİZMA

Renk Seçenekleri
Color Options
Options de Couleur



LED / T16 (T5)

Sıva Üstü 4X Buzlu Difüzörlü
Aydınlatma Armatürleri

Surface Mounted 4X Lighting
Fixtures With Frosted Diffuser

Luminaire Apparents 4X Avec
Diffuseur Givré

UYGULAMA ALANLARI

Ofisler
Toplantı Odaları
Mağazalar
Hastaneler
Okullar
Koridorlar

APPLICATION AREAS

Offices
Meeting rooms
Stores
Hospitals
Schools
Corridors

DOMAINES D'UTILISATION

Bureaux
Salles de Réunion
Magasins
Hopitaux
Ecoles
Coulors

GÖVDE

Beyaz, gümüş, siyah renk seçenekleri ile ince (32mm) zarif tasarıma sahip alüminyum.

DİFÜZÖR

UV korumalı buzlu difüzör.

BALAST (T5 Modeller İçin)

ENEC standartlarına uygun, uzun ömürlü sabit ışık akısına sahip, düşük enerji kayıplı (EEI=A2) elektronik balast.

KONVERTÖR (LED'li Modeller İçin)

ENEC standartlarına uygun, uzun ömürlü sabit akımlı konvertör.

LED (LED'li Modeller İçin)

50.000 saat ömürlü LUMILEDS / OSRAM / SEOUL marka LED'li LED modüller.

BODY

Anodized aluminum with satin finishing. Black, white and silver color options with thin (32mm) elegant design.

DIFFUSER

UV stabilized frosted diffuser.

BALLAST (For T5 Models)

Electronic ballast with long life, low power loss EEI = A2 and constant flux. Compatible with ENEC standards.

CONVERTER (For LED Models)

Long life, low power loss converter with constant current. Compatible with ENEC standards.

LED (For LED Models)

LED modules with 50,000 hours lifetime LUMILEDS / OSRAM / SEOUL brand LEDs.

CORPS

Corps en aluminium anodisé, satiné. Design élégant. Couleurs blanc, argent et noir disponibles. Epaisseur 32 mm.

DIFFUSEUR

Diffuseur givré. Anti UV.

BALLAST (Pour T5 Modèles)

Ballast électronique, conforme aux normes ENEC. Longue vie. Perte de puissance faible (EEI = A2). Flux de lumière régulier.

CONVERTEUR (Pour Modèles LED)

Convertisseur, conforme aux normes ENEC. Longue vie. Perte de puissance faible avec courant constant.

LED (Pour Modèles LED)

Modules LED – Durée de vie 50.000 heures avec LED de marque LUMILEDS / OSRAM / SEOUL.

LED'li Tip / LED Type / Type LED

Renk Geri Verim Indexi / Color Rendering Index / Indice de Rendu des Couleurs: (CRI): Ra>80

Kod Code	Güç Power Puissance (W)	LED Tipi LED Type Type De LED	LED Modül LED Module Module LED	Işık Akısı Lum. Flux Flux Lum. (lm)	Renk Sıcaklığı Color Temperature Température De Couleur (K)	Ölçüler Dimensions (mm)			Ağırlık Weight Poids (kg)	Ambalaj Adedi Packing Quantity Colisage	Adet/20" Konteyner Pcs./20" Container Pcs./20" Conteneur
						a	b	h			
PL4U42L15C	8x6,5	3535 SMD	PCB	6800	3000 / 4000 / 6500	388	645	32	3.2	2	1560
PL4U43L15C	12x6,5	3535 SMD	PCB	10200	3000 / 4000 / 6500	388	925	32	4.5	2	1100
PL4U44L15C	16x6,5	3535 SMD	PCB	13600	3000 / 4000 / 6500	388	1206	32	5.9	2	840
PL4U45L15C	20x6,5	3535 SMD	PCB	17000	3000 / 4000 / 6500	388	1486	32	7.2	2	680

T5 Floresanlı Tip / T5 Fluorescent Type / Type T5 Fluorescent

Kod Code	Güç Power Puissance (W)	Ampul Tipi Lamp Type Type De Lampe	Duy Tipi Socket Type Type De Douille	Işık Akısı Lum. Flux Flux Lum. (lm)	Akım Current Courant (A)	Ölçüler Dimensions (mm)			Ağırlık Weight Poids (kg)	Ambalaj Adedi Packing Quantity Colisage	Adet/20" Konteyner Pcs./20" Container Pcs./20" Conteneur
						a	b	h			
P54U414C	4x14	T16(T5)	G5	4800	0.28	388	593	32	3.0	2	1700
P54U424C	4x24	T16(T5)	G5	7000	0.46	388	593	32	3.0	2	1700
P54U421C	4x21	T16(T5)	G5	7600	0.40	388	893	32	4.4	2	1150
P54U428C	4x28	T16(T5)	G5	10400	0.52	388	1193	32	5.8	2	850
P54U454C	4x54	T16(T5)	G5	17800	1.00	388	1193	32	5.8	2	850
P54U435C	4x35	T16(T5)	G5	13200	0.66	388	1493	32	7.2	2	680
P54U449C	4x49	T16(T5)	G5	17200	0.98	388	1493	32	7.2	2	680
P54U480C	4x80	T16(T5)	G5	24600	1.52	388	1493	32	7.2	2	680

V / Hz 220 - 240 / 50 - 60

Opsiyonlar	Options	Options
DIM edilebilir elektronik balast yada konvertör. LED'li modeller için acil durum kit.	Dimmable electronic ballast or convertor. Emergency kit for models with LED	Ballast électronique dimmable ou converteur. Kit d'urgence pour les modèles LED.

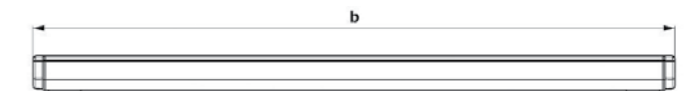





KARE VEGA

Renk Seçenekleri
Color Options
Options de Couleur



LED

Sarkıt Buzlu Akrilik Difüzörlü Aydınlatma Armatürleri

Suspended Lighting Fixtures With Frosted Acrylic Diffuser

Luminaire Suspendus Avec Diffuseur Acrylique Givré

UYGULAMA ALANLARI

Alışveriş Merkezleri
Marketler
Ofisler
Toplantı odaları
Mağazalar
Hastaneler
Okullar
Koridorlar

APPLICATION AREAS

Shopping Malls
Supermarkets
Offices
Meeting rooms
Stores
Hospitals
Schools
Corridors

DOMAINES D'UTILISATION

Centres Commerciaux
Supermarchés
Bureaux
Salles de Réunion
Magasins
Hopitaux
Ecoles
Coulloirs

LED'li Tip / LED Type / Type LED

Renk Geri Verim Indexi / Color Rendering Index / Indice de Rendu des Couleurs: (CRI): Ra>80

Kod Code	Güç Power Puissance (W)	LED Tipi LED Type Type De LED	LED Modül LED Module Module LED	Işık Akısı Lum. Flux Flux Lum. (lm)	Renk Sıcaklığı Color Temperature Température De Couleur (K)	Ölçüler Dimensions (mm) a b h	Ağırlık Weight Poids (kg)	Ambalaj Adedi Packing Quantity Colisage	Adet/20" Konteyner Pcs./20" Container Pcs./20" Conteneur
PL7SK22L15C	8x6,5	3535 SMD	PCB	6800	3000 / 4000 / 6500	640 640 99	5.5	2	420
PL7SK33L15C	12x6,5	3535 SMD	PCB	10200	3000 / 4000 / 6500	921 921 99	8.1	2	210
PL7SK44L15C	16x6,5	3535 SMD	PCB	13600	3000 / 4000 / 6500	1201 1201 99	10.2	2	125
PL7SK55L15C	20x6,5	3535 SMD	PCB	17000	3000 / 4000 / 6500	1482 1482 99	13.3	2	85
PL7SK23L15C	10x6,5	3535 SMD	PCB	8500	3000 / 4000 / 6500	640 921 99	6.8	2	296
PL7SK24L15C	12x6,5	3535 SMD	PCB	10200	3000 / 4000 / 6500	640 1201 99	7.9	2	230
PL7SK34L15C	14x6,5	3535 SMD	PCB	11900	3000 / 4000 / 6500	921 1201 99	9.2	2	162
PL7SK35L15C	16x6,5	3535 SMD	PCB	13600	3000 / 4000 / 6500	921 1482 99	10.2	2	132

GÖVDE

Beyaz, gümüş, siyah renk seçenekleri ile zarif tasarıma sahip alüminyum.

DİFÜZÖR

UV korumalı akrilik difüzör.

KONVERTÖR (LED'li Modeller İçin)

ENEC standartlarına uygun, uzun ömürlü sabit akımlı konvertör.

LED (LED'li Modeller İçin)

50.000 saat ömürlü LUMILEDS / OSRAM / SEOUL marka LED'li LED modülleri.

ASKI

1mm çelik örgü tel ve nikel kaplamalı pirinç parçalardan mamul, askı boyu ayarlanabilir, şeffaf elektrik kablosu ve tavana monte edilen estetik tasarıma sahip elektrik bağlantı kutusu ile birlikte.

BODY

Anodized aluminum with satin finishing. Black, white and silver color options with elegant design.

DIFFUSEUR

UV stabilized acrylic diffuser.

CONVERTER (For LED Models)

Long life, low power loss converter with constant current. Compatible with ENEC standards.

LED (For LED Models)

LED modules with 50,000 hours lifetime LUMILEDS / OSRAM / SEOUL brand LEDs.

SUSPENSION

Composed of 1mm steel wire rope and nickel-plated brass components. Suspension height is adjustable. Supplied with transparent electric cord and ceiling mounted electrical junction box with aesthetic design.

CORPS

Corps en aluminium anodisé, satiné. Design élégant. Couleurs blanc, argent et noir disponibles.

DIFFUSEUR

Diffuseur en acrylique. Anti UV.

CONVERTEUR (Pour Modèles LED)

Convertisseur, conforme aux normes ENEC. Longue vie. Perte de puissance faible avec courant constant.

LED (Pour Modèles LED)

Modules LED – Durée de vie 50.000 heures avec LED de marque LUMILEDS / OSRAM / SEOUL.

SYSTEME DE FIXATION

Composé d'un fil en acier de 1mm, de composants en laiton nickelés. Livré avec un cordon électrique transparent et une boîte de jonction électrique à fixer au plafond. Hauteur de fixation réglable.

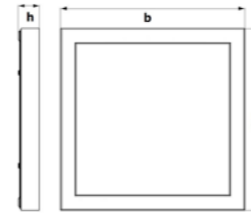

V / Hz 220 - 240 / 50 - 60

Opsiyonlar	Options	Options
DIM edilebilir konvertör. Acil durum kiti.	Dimmable convertor. Emergency kit.	Convertisseur dimmable. Kit d'urgence.

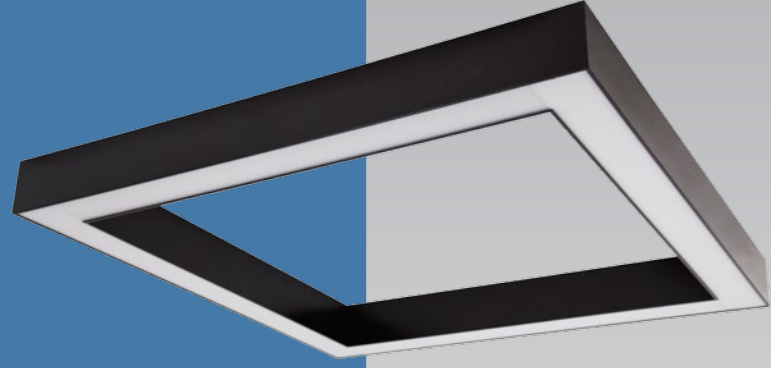

KARE VEGA

Renk Seçenekleri
Color Options
Options de Couleur



LED

Sıva Üstü Buzlu Akrilik Difüzörlü
Aydınlatma Armatürleri

Surface Mounted Lighting Fixtures
With Frosted Acrylic Diffuser

Luminaires Apparents Avec
Diffuseur Acrylique Givré

UYGULAMA ALANLARI

Alışveriş Merkezleri
Marketler
Ofisler
Toplantı odaları
Mağazalar
Hastaneler
Okullar
Koridorlar

APPLICATION AREAS

Shopping Malls
Supermarkets
Offices
Meeting rooms
Stores
Hospitals
Schools
Corridors

DOMAINES D'UTILISATION

Centres Commerciaux
Supermarchés
Bureaux
Salles de Réunion
Magasins
Hopitaux
Ecoles
Couloirs

LED'li Tip / LED Type / Type LED

Renk Geri Verim Indexi / Color Rendering Index / Indice de Rendu des Couleurs: (CRI): Ra>80

Kod Code	Güç Power Puissance (W)	LED Tipi LED Type Type De LED	LED Modül LED Module Module LED	Işık Akısı Lum. Flux Flux Lum. (lm)	Renk Sıcaklığı Color Temperature Température De Couleur (K)	Ölçüler Dimensions (mm) a b h	Ağırlık Weight Poids (kg)	Ambalaj Adedi Packing Quantity Colisage	Adet/20" Konteyner Pcs./20" Conteneur
PL7UK22L15C	8x6,5	3535 SMD	PCB	6800	3000 / 4000 / 6500	640 640 99	5.5	2	420
PL7UK33L15C	12x6,5	3535 SMD	PCB	10200	3000 / 4000 / 6500	921 921 99	8.1	2	210
PL7UK44L15C	16x6,5	3535 SMD	PCB	13600	3000 / 4000 / 6500	1201 1201 99	10.2	2	125
PL7UK55L15C	20x6,5	3535 SMD	PCB	17000	3000 / 4000 / 6500	1482 1482 99	13.3	2	85
PL7UK23L15C	10x6,5	3535 SMD	PCB	8500	3000 / 4000 / 6500	640 921 99	6.8	2	296
PL7UK24L15C	12x6,5	3535 SMD	PCB	10200	3000 / 4000 / 6500	640 1201 99	7.9	2	230
PL7UK34L15C	14x6,5	3535 SMD	PCB	11900	3000 / 4000 / 6500	921 1201 99	9.2	2	162
PL7UK35L15C	16x6,5	3535 SMD	PCB	13600	3000 / 4000 / 6500	921 1482 99	10.2	2	132

GÖVDE

Beyaz, gümüş, siyah renk seçenekleri ile zarif tasarıma sahip alüminyum.

DİFÜZÖR

UV korumalı akrilik difüzör.

KONVERTÖR (LED'li Modeller İçin)

ENEC standartlarına uygun, uzun ömürlü sabit akımlı konvertör.

LED (LED'li Modeller İçin)

50.000 saat ömürlü LUMILEDS / OSRAM / SEOUL marka LED'li LED modülleri.

BODY

Anodized aluminum with satin finishing. Black, white and silver color options with elegant design.

DIFFUSER

UV stabilized acrylic diffuser.

CONVERTER (For LED Models)

Long life, low power loss converter with constant current. Compatible with ENEC standards.

LED (For LED Models)

LED modules with 50,000 hours lifetime LUMILEDS / OSRAM / SEOUL brand LEDs.

CORPS

Corps en aluminium anodisé, satiné. Design élégant. Couleurs blanc, argent et noir disponibles.

DIFFUSEUR

Diffuseur en acrylique. Anti UV.

CONVERTEUR (Pour Modèles LED)

Convertisseur, conforme aux normes ENEC. Longue vie. Perte de puissance faible avec courant constant.

LED (Pour Modèles LED)

Modules LED – Durée de vie 50.000 heures avec LED de marque LUMILEDS / OSRAM / SEOUL.

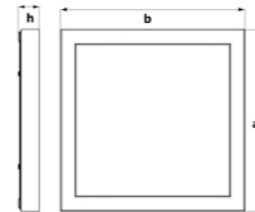

V / Hz 220 - 240 / 50 - 60

Opsiyonlar	Options	Options
DIM edilebilir konvertör. Acil durum kiti.	Dimmable convertor. Emergency kit.	Convertisseur dimmable. Kit d'urgence.

VEGA

Renk Seçenekleri
Color Options
Options de Couleur



LED

Sarkıt Buzlu Akrilik Difüzörlü Aydınlatma Armatürleri

Suspended Lighting Fixtures With Frosted Acrylic Diffuser

Luminaire Suspendus Avec Diffuseur Acrylique Givré

UYGULAMA ALANLARI

Alışveriş Merkezleri
Marketler
Ofisler
Toplantı odaları
Mağazalar
Hastaneler
Okullar
Koridorlar

APPLICATION AREAS

Shopping Malls
Supermarkets
Offices
Meeting rooms
Stores
Hospitals
Schools
Corridors

DOMAINES D'UTILISATION

Centres Commerciaux
Supermarchés
Bureaux
Salles de Réunion
Magasins
Hopitaux
Ecoles
Couloirs

GÖVDE

Beyaz, gümüş, siyah renk seçenekleri ile zarif tasarıma sahip alüminyum.

DİFÜZÖR

UV korumalı akrilik difüzör.

KONVERTÖR

ENEC standartlarına uygun, uzun ömürlü sabit akımlı konvertör.

LED

50.000 saat ömürlü LUMILEDS / OSRAM / SEOUL marka LED'li LED modüller.

ASKI

1mm çelik örgü tel ve nikel kaplamalı pirinç parçalardan mamul, askı boyu ayarlanabilir, şeffaf elektrik kablosu ve tavana monte edilen estetik tasarıma sahip elektrik bağlantı kutusu ile birlikte.

BODY

Anodized aluminum with satin finishing. Black, white and silver color options with elegant design.

DIFFUSER

UV stabilized acrylic diffuser.

CONVERTER

Long life, low power loss converter with constant current. Compatible with ENEC standards.

LED

LED modules with 50,000 hours lifetime LUMILEDS / OSRAM / SEOUL brand LEDs.

SUSPENSION

Composed of 1mm steel wire rope and nickel-plated brass components. Suspension height is adjustable. Supplied with transparent electric cord and ceiling mounted electrical junction box with aesthetic design.

CORPS

Corps en aluminium anodisé, satiné. Design élégant. Couleurs blanc, argent, noir disponibles.

DIFFUSEUR

Diffuseur en acrylique. Anti UV.

CONVERTEUR

Convertisseur, conforme aux normes ENEC. Longue vie. Perte de puissance faible avec courant constant.

LED

Modules LED – Durée de vie 50.000 heures avec LED de marque LUMILEDS / OSRAM / SEOUL.

SYSTEME DE FIXATION

Composé d'un fil en acier de 1mm, de composants en laiton nickelés. Livré avec un cordon électrique transparent et une boîte de jonction électrique à fixer au plafond. Hauteur de fixation réglable.

LED'li Tip / LED Type / Type LED

Renk Geri Verim Indexi / Color Rendering Index / Indice de Rendu des Couleurs: (CRI): Ra>80

Kod Code	Güç Power Puissance (W)	LED Tipi LED Type Type De LED	LED Modül LED Module Module LED	Işık Akısı Lum. Flux Flux Lum. (lm)	Renk Sıcaklığı Color Temperature Température De Couleur (K)	Ölçüler Dimensions (mm)			Ağırlık Weight Poids (kg)	Ambalaj Adedi Packing Quantity Colisage	Adet/20" Konteyner Pcs./20" Container Pcs./20" Conteneur
						a	l	h			
PL7S12L15C	2x6,5	3535 SMD	PCB	1700	3000 / 4000 / 6500	77	569	99	1.9	2	4582
PL7S12L25C	2x12	3535 SMD	PCB	3100	3000 / 4000 / 6500	77	569	99	2.0	2	4582
PL7S13L15C	3x6,5	3535 SMD	PCB	2550	3000 / 4000 / 6500	77	849	99	2.5	2	3106
PL7S13L25C	3x12	3535 SMD	PCB	4650	3000 / 4000 / 6500	77	849	99	2.6	2	3106
PL7S14L15C	4x6,5	3535 SMD	PCB	3400	3000 / 4000 / 6500	77	1130	99	3.1	2	2350
PL7S14L25C	4x12	3535 SMD	PCB	6200	3000 / 4000 / 6500	77	1130	99	3.2	2	2350
PL7S15L15C	5x6,5	3535 SMD	PCB	4250	3000 / 4000 / 6500	77	1410	99	3.7	2	1890
PL7S15L25C	5x12	3535 SMD	PCB	7750	3000 / 4000 / 6500	77	1410	99	3.8	2	1890
PL7S16L15C	6x6,5	3535 SMD	PCB	5100	3000 / 4000 / 6500	77	1691	99	4.3	2	1580
PL7S16L25C	6x12	3535 SMD	PCB	9300	3000 / 4000 / 6500	77	1691	99	4.4	2	1580
PL7S17L15C	7x6,5	3535 SMD	PCB	5950	3000 / 4000 / 6500	77	1971	99	4.9	2	1358
PL7S18L15C	8x6,5	3535 SMD	PCB	6800	3000 / 4000 / 6500	77	2252	99	5.5	2	1190
PL7S19L15C	9x6,5	3535 SMD	PCB	7650	3000 / 4000 / 6500	77	2532	99	6.1	2	1060
PL7S10L15C	10x6,5	3535 SMD	PCB	8500	3000 / 4000 / 6500	77	2813	99	6.7	2	955
PL7S11L15C	11x6,5	3535 SMD	PCB	9350	3000 / 4000 / 6500	77	3094	99	7.3	2	870



V / Hz 220 - 240 / 50 - 60

Opsiyonlar	Options	Options
DIM edilebilir konvertör.	Dimmable converter.	Convertisseur dimmable.
Acil durum kiti.	Emergency kit.	Kit d'urgence.

VEGA

Renk Seçenekleri
Color Options
Options de Couleur



T16 (T5)

Sarkıt Tek Sıralı Buzlu Akrilik
Difüzörlü Aydınlatma Armatürleri

Suspended Single Line Lighting

Fixtures with Frosted Acrylic Diffuser

Luminaire Suspendus

Avec Diffuseur

Acrylique Givré - 1 Ligne

UYGULAMA ALANLARI

Alışveriş Merkezleri
Marketler
Ofisler
Toplantı odaları
Mağazalar
Hastaneler
Okullar
Koridorlar

APPLICATION AREAS

Shopping Malls
Supermarkets
Offices
Meeting rooms
Stores
Hospitals
Schools
Corridors

DOMAINES D'UTILISATION

Centres Commerciaux
Supermarchés
Bureaux
Salles de Réunion
Magasins
Hopitaux
Ecoles
Couloirs

GÖVDE

Beyaz, gümüş, siyah renk seçenekleri ile zarif tasarıma sahip alüminyum.

DİFÜZÖR

UV korumalı akrilik difüzör.

BALAST

ENEC standartlarına uygun, uzun ömürlü sabit ışık akısına sahip, düşük enerji kayıplı (EEI=A2) elektronik balast.

ASKI

1mm çelik örgü tel ve nikel kaplamalı pirinç parçalardan mamul, askı boyu ayarlanabilir, şeffaf elektrik kablosu ve tavana monte edilen estetik tasarıma sahip elektrik bağlantı kutusu ile birlikte.

BODY

Anodized aluminum with satin finishing. Black, white and silver color options with elegant design.

DIFFUSER

UV stabilized acrylic diffuser.

BALLAST

Electronic ballast with long life, low power loss EEI = A2 and constant flux. Compatible with ENEC standards.

SUSPENSION

Composed of 1mm steel wire rope and nickel-plated brass components. Suspension height is adjustable. Supplied with transparent electric cord and ceiling mounted electrical junction box with aesthetic design.

CORPS

Corps en aluminium anodisé, satiné. Design élégant. Couleurs blanc, argent et noir disponibles.

DIFFUSEUR

Diffuseur prismatique en. Anti UV.

BALLAST

Ballast électronique, conforme aux normes ENEC. Longue vie. Perte de puissance faible (EEI = A2). Flux de lumière régulier.

SYSTEME DE FIXATION

Composé d'un fil en acier de 1mm, de composants en laiton nickelés. Livré avec un cordon électrique transparent et une boîte de jonction électrique à fixer au plafond. Hauteur de fixation réglable.

T5 Floresanlı Tip / T5 Fluorescent Type / Type T5 Fluorescent

Kod Code	Güç Power Puissance (W)	Ampul Tipi Lamp Type Typ. De Lamp.	Duy Tipi Socket Type Type De Douille	Işık Akısı Lum. Flux Flux Lum. (lm)	Akım Current Courant (A)	Ölçüler Dimensions (mm) a l h	Ağırlık Weight Poids (kg)	Ambalaj Adedi Packing Quantity Colisage	Adet/20" Konteyner Pcs./20" Conteneur	Resim No Drawing No
P57S114C	1x14	T16(T5)	G5	1200	0.08	77 569 99	2.1	2	4430	1
P57S124C	1x24	T16(T5)	G5	1750	0.12	77 569 99	2.1	2	4430	
P57S121C	1x21	T16(T5)	G5	1900	0.11	77 849 99	2.7	2	3020	
P57S128C	1x28	T16(T5)	G5	2600	0.14	77 1181 99	3.3	2	2190	
P57S154C	1x54	T16(T5)	G5	4450	0.26	77 1181 99	3.3	2	2190	
P57S135C	1x35	T16(T5)	G5	3300	0.17	77 1481 99	3.9	2	1760	
P57S149C	1x49	T16(T5)	G5	4300	0.24	77 1481 99	3.9	2	1760	
P57S180C	1x80	T16(T5)	G5	6150	0.38	77 1481 99	3.9	2	1760	
P57S228C	2x28	T16(T5)	G5	5200	0.26	77 2226 99	5.5	2	1180	
P57S254C	2x54	T16(T5)	G5	8900	0.50	77 2226 99	5.5	2	1180	
P57S235C	2x35	T16(T5)	G5	6600	0.33	77 2826 99	6.8	2	940	2
P57S249C	2x49	T16(T5)	G5	8600	0.49	77 2826 99	6.8	2	940	
P57S280C	2x80	T16(T5)	G5	12300	0.76	77 2826 99	6.8	2	940	

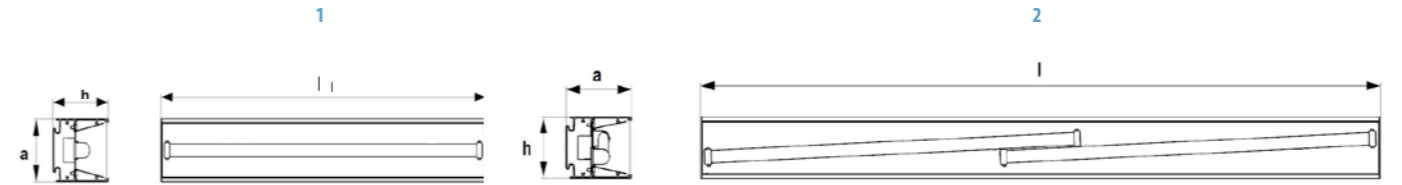

V / Hz 220 - 240 / 50 - 60

Opsiyonlar	Options	Options
DIM edilebilir ballast.	Dimmable ballast.	Ballast dimmable.
Acil durum kiti.	Emergency kit.	Kit d'urgence.

VEGA

Renk Seçenekleri
Color Options
Options de Couleur



T16 (T5)

Sarkıt Çift Sıralı Buzlu Akrilik
Difüzörlü Aydınlatma Armatürleri

Suspended Double Line Lighting

Fixtures with Frosted Acrylic Diffuser

Luminaire Suspendus Avec

Diffuseur Acrylique Givré – 2 Lignes

UYGULAMA ALANLARI

Alışveriş Merkezleri
Marketler
Ofisler
Toplantı odaları
Mağazalar
Hastaneler
Okullar
Koridorlar

APPLICATION AREAS

Shopping Malls
Supermarkets
Offices
Meeting rooms
Stores
Hospitals
Schools
Corridors

DOMAINES D'UTILISATION

Centres Commerciaux
Supermarchés
Bureaux
Salles de Réunion
Magasins
Hopitaux
Ecoles
Couloirs

T5 Floresanlı Tip / T5 Fluorescent Type / Type T5 Fluorescent

Kod Code	Güç Power Puissance (W)	Ampul Tipi Lamp Type Typ. De Lamp.	Duy Tipi Socket Type Type De Douille	Işık Akısı Lum. Flux Flux Lum. (lm)	Akım Current Courant (A)	Ölçüler Dimensions (mm)			Ağırlık Weight Poids (kg)	Ambalaj Adedi Packing Quantity Colisage	Adet/20" Konteyner Pcs./20" Container Pcs./20" Conteneur
						a	l	h			
P57S214C2	2x14	T16(T5)	G5	2400	0.14	77	569	99	2.0	2	4430
P57S224C2	2x24	T16(T5)	G5	3500	0.23	77	569	99	2.0	2	4430
P57S221C2	2x21	T16(T5)	G5	3800	0.20	77	849	99	2.7	2	3020
P57S228C2	2x28	T16(T5)	G5	5200	0.26	77	1181	99	3.4	2	2190
P57S254C2	2x54	T16(T5)	G5	8900	0.50	77	1181	99	3.4	2	2190
P57S235C2	2x35	T16(T5)	G5	6600	0.33	77	1481	99	4.1	2	1760
P57S249C2	2x49	T16(T5)	G5	8600	0.49	77	1481	99	4.1	2	1760
P57S280C2	2x80	T16(T5)	G5	12300	0.76	77	1481	99	4.1	2	1760

GÖVDE

Beyaz, gümüş, siyah renk seçenekleri ile zarif tasarıma sahip alüminyum.

DİFÜZÖR

UV korumalı akrilik difüzör.

BALAST

ENEC standartlarına uygun, uzun ömürlü sabit ışık akısına sahip, düşük enerji kayıplı (EEI=A2) elektronik balast.

ASKI

1mm çelik örgü tel ve nikel kaplamalı pirinç parçalardan mamul, askı boyu ayarlanabilir, şeffaf elektrik kablosu ve tavana monte edilen estetik tasarıma sahip elektrik bağlantı kutusu ile birlikte.

BODY

Anodized aluminum with satin finishing. Black, white and silver color options with elegant design.

DIFFUSER

UV stabilized acrylic diffuser.

BALLAST

Electronic ballast with long life, low power loss EEI = A2 and constant flux. Compatible with ENEC standards.

SUSPENSION

Composed of 1mm steel wire rope and nickel-plated brass components. Suspension height is adjustable. Supplied with transparent electric cord and ceiling mounted electrical junction box with aesthetic design.

CORPS

Corps en aluminium anodisé, satiné. Design élégant. Couleurs blanc, argent et noir disponibles.

DIFFUSEUR

Diffuseur en acrylique. Anti UV.

BALLAST

Ballast électronique, conforme aux normes ENEC. Longue vie. Perte de puissance faible (EEI = A2). Flux de lumière régulier.

SYSTEME DE FIXATION

Composé d'un fil en acier de 1mm, de composants en laiton nickelés. Livré avec un cordon électrique transparent et une boîte de jonction électrique à fixer au plafond. Hauteur de fixation réglable.

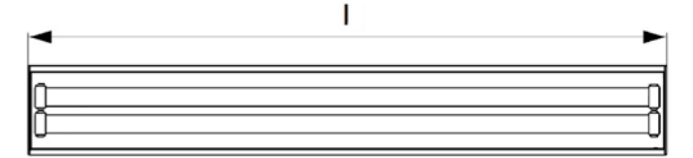
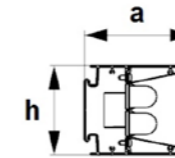

V / Hz 220 - 240 / 50 - 60

Opsiyonlar	Options	Options
DIM edilebilir ballast.	Dimmable ballast.	Ballast dimmable.
Acil durum kiti.	Emergency kit.	Kit d'urgence.

VEGA

Renk Seçenekleri
Color Options
Options de Couleur



LED

Sıva Üstü Buzlu Akrilik Difüzörlü Aydınlatma Armatürleri

Surface Mounted Lighting Fixtures
With Frosted Acrylic Diffuser
Luminares Apparents
Avec Diffuseur Acrylique Givré

UYGULAMA ALANLARI

Alışveriş Merkezleri
Marketler
Ofisler
Toplantı odaları
Mağazalar
Hastaneler
Okullar
Koridorlar

APPLICATION AREAS

Shopping Malls
Supermarkets
Offices
Meeting rooms
Stores
Hospitals
Schools
Corridors

DOMAINES D'UTILISATION

Centres Commerciaux
Supermarchés
Bureaux
Salles de Réunion
Magasins
Hopitaux
Ecoles
Couloirs

GÖVDE

Gümüş, beyaz ve siyah renkli, zarif tasarıma sahip, satin eloksallı kaplamalı alüminyum.

DİFÜZÖR

UV korumalı akrilik difüzör.

KONVERTÖR

ENEC standartlarına uygun, uzun ömürlü sabit akımlı konvertör.

LED

50.000 saat ömürlü LUMILEDS / OSRAM / SEOUL marka LED'li LED modülleri.

BODY

Anodized aluminum with satin finishing, elegant design with white, black and silver color.

DIFFUSER

UV stabilized acrylic diffuser.

CONVERTER

Long life, low power loss converter with constant current. Compatible with ENEC standards.

LED

LED modules with 50,000 hours lifetime LUMILEDS / OSRAM / SEOUL brand LEDs.

CORPS

Corps en aluminium anodisé, satiné. Design elegant couleur argent, blanc et noir.

DIFFUSEUR

Diffuseur en acrylique anti UV.

CONVERTEUR

Convertisseur, conforme aux normes ENEC. Longue vie. Perte de puissance faible avec courant constant.

LED

Modules LED - Durée de vie 50.000 heures avec LED de marque LUMILEDS / OSRAM / SEOUL.

V / Hz 220 - 240 / 50 - 60

Opsiyonlar	Options	Options
DİM edilebilir konvertör.	Dimmable converter.	Convertisseur dimmable.
Acil durum kiti.	Emergency kit.	Kit d'urgence.



Renk Geri Verim İndeksi / Color Rendering Index / Indice de Rendu des Couleurs: (CRI): Ra>80

Kod Code	Güç Power Puissance (W)	LED Tipi LED Type Type De LED	LED Modül LED Module Module LED	Işık Akısı Lum. Flux Flux Lum. (lm)	Renk Sıcaklığı Color Temperature Température De Couleur (K)	Ölçüler Dimensions (mm)			Ağırlık Weight Poids (kg)	Ambalaj Adedi Packing Quantity Colisage	Adet/20" Konteyner Pcs./20" Conteneur
						a	l	h			
PL7U12L15C	2x6,5	3535 SMD	PCB	1700	3000 / 4000 / 6500	77	569	99	1,7	2	4582
PL7U12L15CSB	2x6,5	3535 SMD	PCB	1700	3000 / 4000 / 6500	77	567	99	1,7	2	4582
PL7U12L15CSO	2x6,5	3535 SMD	PCB	1700	3000 / 4000 / 6500	77	566	99	1,7	2	4582
PL7U12L25C	2x12	3535 SMD	PCB	3100	3000 / 4000 / 6500	77	569	99	1,7	2	4582
PL7U12L25CSB	2x12	3535 SMD	PCB	3100	3000 / 4000 / 6500	77	567	99	1,7	2	4582
PL7U12L25CSO	2x12	3535 SMD	PCB	3100	3000 / 4000 / 6500	77	566	99	1,7	2	4582
PL7U13L15C	3x6,5	3535 SMD	PCB	2550	3000 / 4000 / 6500	77	849	99	2,3	2	3106
PL7U13L15CSB	3x6,5	3535 SMD	PCB	2550	3000 / 4000 / 6500	77	847	99	2,3	2	3106
PL7U13L15CSO	3x6,5	3535 SMD	PCB	2550	3000 / 4000 / 6500	77	846	99	2,3	2	3106
PL7U13L25C	3x12	3535 SMD	PCB	4650	3000 / 4000 / 6500	77	849	99	2,3	2	3106
PL7U13L25CSB	3x12	3535 SMD	PCB	4650	3000 / 4000 / 6500	77	847	99	2,3	2	3106
PL7U13L25CSO	3x12	3535 SMD	PCB	4650	3000 / 4000 / 6500	77	846	99	2,3	2	3106
PL7U14L15C	4x6,5	3535 SMD	PCB	3400	3000 / 4000 / 6500	77	1130	99	2,9	2	2350
PL7U14L15CSB	4x6,5	3535 SMD	PCB	3400	3000 / 4000 / 6500	77	1128	99	2,9	2	2350
PL7U14L15CSO	4x6,5	3535 SMD	PCB	3400	3000 / 4000 / 6500	77	1127	99	2,9	2	2350
PL7U14L25C	4x12	3535 SMD	PCB	6200	3000 / 4000 / 6500	77	1130	99	2,9	2	2350
PL7U14L25CSB	4x12	3535 SMD	PCB	6200	3000 / 4000 / 6500	77	1128	99	2,9	2	2350
PL7U14L25CSO	4x12	3535 SMD	PCB	6200	3000 / 4000 / 6500	77	1127	99	2,9	2	2350
PL7U15L15C	5x6,5	3535 SMD	PCB	4250	3000 / 4000 / 6500	77	1410	99	3,5	2	1890
PL7U15L15CSB	5x6,5	3535 SMD	PCB	4250	3000 / 4000 / 6500	77	1408	99	3,5	2	1890
PL7U15L15CSO	5x6,5	3535 SMD	PCB	4250	3000 / 4000 / 6500	77	1407	99	3,5	2	1890
PL7U15L25C	5x12	3535 SMD	PCB	7750	3000 / 4000 / 6500	77	1410	99	3,5	2	1890
PL7U15L25CSB	5x12	3535 SMD	PCB	7750	3000 / 4000 / 6500	77	1408	99	3,5	2	1890
PL7U15L25CSO	5x12	3535 SMD	PCB	7750	3000 / 4000 / 6500	77	1407	99	3,5	2	1890
PL7U16L15C	6x6,5	3535 SMD	PCB	5100	3000 / 4000 / 6500	77	1691	99	4,1	2	1580
PL7U16L15CSB	6x6,5	3535 SMD	PCB	5100	3000 / 4000 / 6500	77	1689	99	4,1	2	1580
PL7U16L15CSO	6x6,5	3535 SMD	PCB	5100	3000 / 4000 / 6500	77	1688	99	4,1	2	1580
PL7U16L25C	6x12	3535 SMD	PCB	9300	3000 / 4000 / 6500	77	1691	99	4,1	2	1580
PL7U16L25CSB	6x12	3535 SMD	PCB	9300	3000 / 4000 / 6500	77	1689	99	4,1	2	1580
PL7U16L25CSO	6x12	3535 SMD	PCB	9300	3000 / 4000 / 6500	77	1688	99	4,1	2	1580
PL7U17L15C	7x6,5	3535 SMD	PCB	5950	3000 / 4000 / 6500	77	1971	99	4,7	2	1358
PL7U17L15CSB	7x6,5	3535 SMD	PCB	5950	3000 / 4000 / 6500	77	1969	99	4,7	2	1358
PL7U17L15CSO	7x6,5	3535 SMD	PCB	5950	3000 / 4000 / 6500	77	1968	99	4,7	2	1358
PL7U18L15C	8x6,5	3535 SMD	PCB	6800	3000 / 4000 / 6500	77	2252	99	5,3	2	1190
PL7U18L15CSB	8x6,5	3535 SMD	PCB	6800	3000 / 4000 / 6500	77	2250	99	5,3	2	1190
PL7U18L15CSO	8x6,5	3535 SMD	PCB	6800	3000 / 4000 / 6500	77	2249	99	5,3	2	1190
PL7U19L15C	9x6,5	3535 SMD	PCB	7650	3000 / 4000 / 6500	77	2532	99	5,9	2	1060
PL7U19L15CSB	9x6,5	3535 SMD	PCB	7650	3000 / 4000 / 6500	77	2530	99	5,9	2	1060
PL7U19L15CSO	9x6,5	3535 SMD	PCB	7650	3000 / 4000 / 6500	77	2529	99	5,9	2	1060
PL7U10L15C	10x6,5	3535 SMD	PCB	8500	3000 / 4000 / 6500	77	2813	99	6,5	2	955
PL7U10L15CSB	10x6,5	3535 SMD	PCB	8500	3000 / 4000 / 6500	77	2811	99	6,5	2	955
PL7U10L15CSO	10x6,5	3535 SMD	PCB	8500	3000 / 4000 / 6500	77	2810	99	6,5	2	955
PL7U11L15C	11x6,5	3535 SMD	PCB	9350	3000 / 4000 / 6500	77	3093	99	7,1	2	870
PL7U11L15CSB	11x6,5	3535 SMD	PCB	9350	3000 / 4000 / 6500	77	3091	99	7,1	2	870
PL7U11L15CSO	11x6,5	3535 SMD	PCB	9350	3000 / 4000 / 6500	77	3090	99	7,1	2	870

VEGA

Renk Seçenekleri
Color Options
Options de Couleur



T16 (T5)

Sıva Üstü Tek Sıralı Buzlu Akrilik
Difüzörlü Aydınlatma Armatürleri

Surface Mounted Single Line Lighting
Fixtures with Frosted Acrylic Diffuser
Luminaires Apparents Avec
Diffuseur Acrylique Givré - 1 Ligne

UYGULAMA ALANLARI

Alışveriş Merkezleri
Marketler
Ofisler
Toplantı odaları
Mağazalar
Hastaneler
Okullar
Koridorlar

APPLICATION AREAS

Shopping Malls
Supermarkets
Offices
Meeting rooms
Stores
Hospitals
Schools
Corridors

DOMAINES D'UTILISATION

Centres Commerciaux
Supermarchés
Bureaux
Salles de Réunion
Magasins
Hopitaux
Ecoles
Couloirs

GÖVDE

Beyaz, siyah ve gümüş renkli, zarif tasarıma sahip, saten eloksallı alüminyum.

DİFÜZÖR

UV korumalı akrilik difüzör.

BALAST

ENEC standartlarına uygun, uzun ömürlü sabit ışık akısına sahip, düşük enerji kayıplı (EEI=A2) elektronik balast.

BODY

Anodized aluminum with satin finishing, elegant design with black, white and silver color.

DIFFUSER

UV stabilized acrylic diffuser.

BALLAST

Electronic ballast with long life, low power loss EEI = A2 and constant flux. Compatible with ENEC standards.

CORPS

Corps en aluminium anodisé, satiné. Design elegant couleur argent, blanc et noir.

DIFFUSEUR

Diffuseur en acrylique anti UV.

BALLAST

Ballast électronique, conforme aux normes ENEC. Longue vie. Perte de puissance faible (EEI = A2). Flux de lumière régulier.

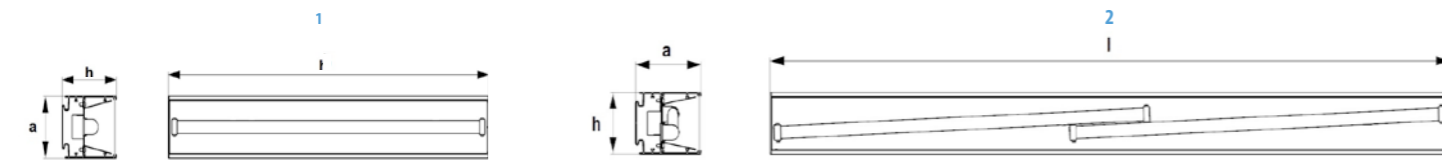

Opsiyonlar	Options	Options
DIM edilebilir balast.	Dimmable ballast.	Ballast dimmable.
Acil durum kit.	Emergency kit.	Kit d'urgence.

V / Hz

220 - 240 / 50 - 60

T5 Floresanlı Tip / T5 Fluorescent Type / Type T5 Fluorescent

Kod Code	Güç Power Puissance (W)	Ampul Tipi Lamp Type Typ. De Lamp.	Duy Tipi Socket Type Type De Douille	Işık Akısı Lum. Flux Flux Lum. (lm)	Akım Current Courant (A)	Ölçüler Dimensions (mm) a l h	Ağırlık Weight Poids (kg)	Ambalaj Adedi Packing Quantity Colisage	Adet/20" Konteyner Pcs./20" Conteneur	Resim No Drawing No Dessin No
P57U114C	1x14	T16(T5)	G5	1200	0.08	77 581 99	1.9	2	5280	1
P57U114CSB	1x14	T16(T5)	G5	1200	0.08	77 579 99	1.9	2	5280	
P57U114CSO	1x14	T16(T5)	G5	1200	0.08	77 578 99	1.9	2	5280	
P57U124C	1x24	T16(T5)	G5	1750	0.12	77 581 99	1.9	2	5280	
P57U124CSB	1x24	T16(T5)	G5	1750	0.12	77 579 99	1.9	2	5280	
P57U124CSO	1x24	T16(T5)	G5	1750	0.12	77 578 99	1.9	2	5280	
P57U121C	1x21	T16(T5)	G5	1900	0.11	77 881 99	2.5	2	3080	
P57U121CSB	1x21	T16(T5)	G5	1900	0.11	77 879 99	2.5	2	3080	
P57U121CSO	1x21	T16(T5)	G5	1900	0.11	77 878 99	2.5	2	3080	
P57U128C	1x28	T16(T5)	G5	2600	0.14	77 1181 99	3.1	2	2252	
P57U128CSB	1x28	T16(T5)	G5	2600	0.14	77 1179 99	3.1	2	2252	
P57U128CSO	1x28	T16(T5)	G5	2600	0.14	77 1178 99	3.1	2	2252	
P57U154C	1x54	T16(T5)	G5	4450	0.26	77 1181 99	3.1	2	2252	
P57U154CSB	1x54	T16(T5)	G5	4450	0.26	77 1179 99	3.1	2	2252	
P57U154CSO	1x54	T16(T5)	G5	4450	0.26	77 1178 99	3.1	2	2252	
P57U135C	1x35	T16(T5)	G5	3300	0.17	77 1481 99	3.7	2	1802	
P57U135CSB	1x35	T16(T5)	G5	3300	0.17	77 1479 99	3.7	2	1802	
P57U135CSO	1x35	T16(T5)	G5	3300	0.17	77 1478 99	3.7	2	1802	
P57U149C	1x49	T16(T5)	G5	4300	0.24	77 1481 99	3.7	2	1802	
P57U149CSB	1x49	T16(T5)	G5	4300	0.24	77 1479 99	3.7	2	1802	
P57U149CSO	1x49	T16(T5)	G5	4300	0.24	77 1478 99	3.7	2	1802	
P57U180C	1x80	T16(T5)	G5	6150	0.38	77 1481 99	3.7	2	1802	
P57U180CSB	1x80	T16(T5)	G5	6150	0.38	77 1479 99	3.7	2	1802	
P57U180CSO	1x80	T16(T5)	G5	6150	0.38	77 1478 99	3.7	2	1802	
P57U228C	2x28	T16(T5)	G5	5200	0.26	77 2226 99	5.3	2	1200	
P57U228CSB	2x28	T16(T5)	G5	5200	0.26	77 2224 99	5.3	2	1200	
P57U228CSO	2x28	T16(T5)	G5	5200	0.26	77 2223 99	5.3	2	1200	
P57U254C	2x54	T16(T5)	G5	8900	0.50	77 2226 99	5.3	2	1200	
P57U254CSB	2x54	T16(T5)	G5	8900	0.50	77 2224 99	5.3	2	1200	
P57U254CSO	2x54	T16(T5)	G5	8900	0.50	77 2223 99	5.3	2	1200	
P57U235C	2x35	T16(T5)	G5	6600	0.33	77 2826 99	6.6	2	948	
P57U235CSB	2x35	T16(T5)	G5	6600	0.33	77 2824 99	6.6	2	948	
P57U235CSO	2x35	T16(T5)	G5	6600	0.33	77 2823 99	6.6	2	948	
P57U249C	2x49	T16(T5)	G5	8600	0.49	77 2826 99	6.6	2	948	
P57U249CSB	2x49	T16(T5)	G5	8600	0.49	77 2824 99	6.6	2	948	
P57U249CSO	2x49	T16(T5)	G5	8600	0.49	77 2823 99	6.6	2	948	
P57U280C	2x80	T16(T5)	G5	12300	0.76	77 2826 99	6.6	2	948	
P57U280CSB	2x80	T16(T5)	G5	12300	0.76	77 2824 99	6.6	2	948	
P57U280CSO	2x80	T16(T5)	G5	12300	0.76	77 2823 99	6.6	2	948	

2

VEGA

Renk Seçenekleri
Color Options
Options de Couleur



T16 (T5)

Sıva Üstü Çift Sıralı Buzlu Akrilik
Difüzörlü Aydınlatma Armatürleri

Surface Mounted Double Line Lighting
Fixtures with Frosted Acrylic Diffuser

Luminaire Apparents Avec Diffuseur
Acrylique Givré – 2 Lignes

UYGULAMA ALANLARI

Alışveriş Merkezleri
Marketler
Ofisler
Toplantı odaları
Mağazalar
Hastaneler
Okullar
Koridorlar

APPLICATION AREAS

Shopping Malls
Supermarkets
Offices
Meeting rooms
Stores
Hospitals
Schools
Corridors

DOMAINES D'UTILISATION

Centres Commerciaux
Supermarchés
Bureaux
Salles de Réunion
Magasins
Hopitaux
Ecoles
Coulloirs

GÖVDE

Beyaz, siyah ve gümüş renkli, zarif tasarıma sahip, saten eloksallı alüminyum.

DİFÜZÖR

UV korumalı akrilik difüzör.

BALAST

ENEC standartlarına uygun, uzun ömürlü sabit ışık akısına sahip, düşük enerji kayıplı (EEI=A2) elektronik balast.

BODY

Anodized aluminum with satin finishing, elegant design with black, white and silver color.

DIFFUSER

UV stabilized acrylic diffuser.

BALLAST

Electronic ballast with long life, low power loss EEI = A2 and constant flux. Compatible with ENEC standards.

CORPS

Corps en aluminium anodisé, satiné. Design elegant couleur argent, blanc et noir.

DIFFUSEUR

Diffuseur en acrylique anti UV.

BALLAST

Ballast électronique, conforme aux normes ENEC. Longue vie. Perte de puissance faible (EEI = A2). Flux de lumière régulier.

T5 Floresanlı Tip / T5 Fluorescent Type / Type T5 Fluorescent

Kod Code	Güç Power Puissance (W)	Ampul Tipi Lamp Type Typ. De Lamp.	Duy Tipi Socket Type Type De Douille	Işık Akısı Lum. Flux Flux Lum. (lm)	Akım Current Courant (A)	Ölçüler Dimensions (mm)			Ağırlık Weight Poids (kg)	Ambalaj Adedi Packing Quantity Colisage	Adet/20" Konteyner Pcs./20" Conteneur	Resim No Drawing No Dessin No
						a	l	h				
P57U214C2	2x14	T16(T5)	G5	2400	0.14	77	581	99	1.8	2	4570	1
P57U214C2SB	2x14	T16(T5)	G5	2400	0.14	77	643	99	1.9	2	4130	
P57U214C2S0	2x14	T16(T5)	G5	2400	0.14	77	576	99	1.9	2	4610	2
P57U224C2	2x24	T16(T5)	G5	3500	0.23	77	581	99	1.8	2	4570	1
P57U224C2SB	2x24	T16(T5)	G5	3500	0.23	77	643	99	1.9	2	4130	
P57U224C2S0	2x24	T16(T5)	G5	3500	0.23	77	576	99	1.9	2	4610	2
P57U221C2	2x21	T16(T5)	G5	3800	0.20	77	881	99	2.5	2	3016	1
P57U221C2SB	2x21	T16(T5)	G5	3800	0.20	77	943	99	2.6	2	2820	
P57U221C2S0	2x21	T16(T5)	G5	3800	0.20	77	876	99	2.6	2	3030	2
P57U228C2	2x28	T16(T5)	G5	5200	0.26	77	1181	99	3.2	2	2250	1
P57U228C2SB	2x28	T16(T5)	G5	5200	0.26	77	1243	99	3.3	2	2140	
P57U228C2S0	2x28	T16(T5)	G5	5200	0.26	77	1176	99	3.3	2	2260	2
P57U254C2	2x54	T16(T5)	G5	8900	0.50	77	1181	99	3.2	2	2250	1
P57U254C2SB	2x54	T16(T5)	G5	8900	0.50	77	1243	99	3.3	2	2140	
P57U254C2S0	2x54	T16(T5)	G5	8900	0.50	77	1176	99	3.3	2	2260	2
P57U235C2	2x35	T16(T5)	G5	6600	0.33	77	1481	99	3.9	2	1800	1
P57U235C2SB	2x35	T16(T5)	G5	6600	0.33	77	1543	99	4.0	2	1730	
P57U235C2S0	2x35	T16(T5)	G5	6600	0.33	77	1476	99	4.0	2	1810	2
P57U249C2	2x49	T16(T5)	G5	8600	0.49	77	1481	99	3.9	2	1800	1
P57U249C2SB	2x49	T16(T5)	G5	8600	0.49	77	1543	99	4.0	2	1730	
P57U249C2S0	2x49	T16(T5)	G5	8600	0.49	77	1476	99	4.0	2	1810	2
P57U280C2	2x80	T16(T5)	G5	12300	0.76	77	1481	99	3.9	2	1800	1
P57U280C2SB	2x80	T16(T5)	G5	12300	0.76	77	1543	99	4.0	2	1730	
P57U280C2S0	2x80	T16(T5)	G5	12300	0.76	77	1476	99	4.0	2	1810	2

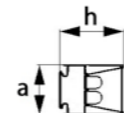
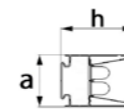

V / Hz 220 - 240 / 50 - 60

Opsiyonlar	Options	Options
DIM edilebilir ballast.	Dimmable ballast.	Ballast dimmable.
Acil durum kit.	Emergency kit.	Kit d'urgence.



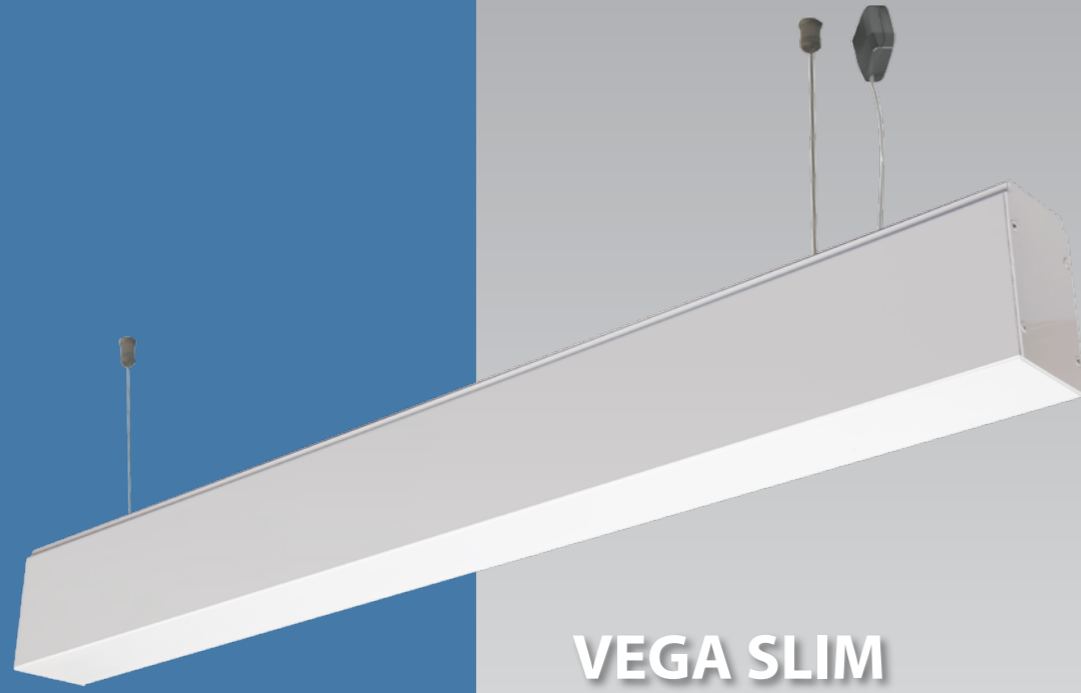

VEGA SLIM

Renk Seçenekleri
Color Options
Options de Couleur



LED / T16 (T5)

Sarkıt Difüzörlü
Aydınlatma Armatürleri

Suspended Lighting Fixtures
With Diffuser

Luminares Suspendus Avec
Diffuseur

UYGULAMA ALANLARI

Alışveriş Merkezleri
Marketler
Ofisler
Toplantı odaları
Mağazalar
Hastaneler
Okullar
Koridorlar

APPLICATION AREAS

Shopping Malls
Supermarkets
Offices
Meeting rooms
Stores
Hospitals
Schools
Corridors

DOMAINES D'UTILISATION

Centres Commerciaux
Supermarchés
Bureaux
Salles de Réunion
Magasins
Hopitaux
Ecoles
Coulloirs

GÖVDE

Beyaz, gümüş, siyah renk seçenekleri ile ince, zarif tasarıma sahip alüminyum.

DİFÜZÖR

UV korumalı PC difüzör.

BALAST (T5 Modeller İçin)

ENEC standartlarına uygun, uzun ömürlü sabit ışık akısına sahip, düşük enerji kayıplı (EEI=A2) elektronik balast.

KONVERTÖR (LED'li Modeller İçin)

ENEC standartlarına uygun, uzun ömürlü sabit akımlı konvertör.

LED (LED'li Modeller İçin)

50.000 saat ömürlü LUMILEDS / OSRAM / SEOUL marka LED'li LED modüller.

ASKI

1mm çelik örgü tel ve nikel kaplamalı pirinç parçalardan mamul, askı boyu ayarlanabilir, şeffaf elektrik kablosu ve tavana monte edilen estetik tasarıma sahip elektrik bağlantı kutusu ile birlikte.

BODY

Anodized aluminum with satin finishing. Black, white and silver color options with thin elegant design.

DIFFUSEUR

UV stabilized PC diffuser.

BALLAST (For T5 Models)

Electronic ballast with long life, low power loss EEI = A2 and constant flux. Compatible with ENEC standards.

CONVERTER (For LED Models)

Long life, low power loss converter with constant current. Compatible with ENEC standards.

LED (For LED Models)

LED modules with 50,000 hours lifetime LUMILEDS / OSRAM / SEOUL brand LEDs.

SUSPENSION

Composed of 1mm steel wire rope and nickel plated brass components. Suspension height is adjustable. Supplied with transparent electric cord and ceiling mounted electrical junction box with aesthetic design.

CORPS

Corps en aluminium anodisé, satiné. Design élégant. Couleurs blanc, argent et noir disponibles.

DIFFUSEUR

Diffuseur en PC Anti UV.

BALLAST (Pour T5 Modèles)

Ballast électronique, conforme aux normes ENEC. Longue vie. Perte de puissance faible (EEI = A2). Flux de lumière régulier.

CONVERTEUR (Pour Modèles LED)

Convertisseur, conforme aux normes ENEC. Longue vie. Perte de puissance faible avec courant constant.

LED (Pour Modèles LED)

Modules LED - Durée de vie 50.000 heures avec LED de marque LUMILEDS / OSRAM / SEOUL.

SYSTEME DE FIXATION

Composé d'un fil en acier de 1mm, de composants en laiton nickelés. Livré avec un cordon électrique transparent et une boîte de jonction électrique à fixer au plafond. Hauteur de fixation réglable.

LED'li Tip / LED Type / Type LED

Renk Geri Verim Indexi / Color Rendering Index / Indice de Rendu des Couleurs: (CRI): Ra>80

Kod Code	Güç Power Puissance (W)	LED Tipi LED Type Type De LED	LED Modül LED Module Module LED	Işık Akısı Lum. Flux Flux Lum. (lm)	Renk Sıcaklığı Color Temperature Température De Couleur (K)	Ölçüler Dimensions (mm)			Ağırlık Weight Poids (kg)	Ambalaj Adedi Packing Quantity Colisage	Adet/20" Konteyner Pcs./20" Container Pcs./20" Conteneur
						a	l	h			
PL13S12L15C	2x6,5	3535 SMD	PCB	1700	3000 / 4000 / 6500	64	569	97	1.5	2	4630
PL13S12L25C	2x12	3535 SMD	PCB	3100	3000 / 4000 / 6500	64	569	97	1.6	2	4630
PL13S13L15C	3x6,5	3535 SMD	PCB	2550	3000 / 4000 / 6500	64	849	97	1.9	2	3480
PL13S13L25C	3x12	3535 SMD	PCB	4650	3000 / 4000 / 6500	64	849	97	2.0	2	3480
PL13S14L15C	4x6,5	3535 SMD	PCB	3400	3000 / 4000 / 6500	64	1130	97	2.3	2	2790
PL13S14L25C	4x12	3535 SMD	PCB	6200	3000 / 4000 / 6500	64	1130	97	2.4	2	2790
PL13S15L15C	5x6,5	3535 SMD	PCB	4250	3000 / 4000 / 6500	64	1410	97	2.7	2	2320
PL13S15L25C	5x12	3535 SMD	PCB	7750	3000 / 4000 / 6500	64	1410	97	2.8	2	2320
PL13S16L15C	6x6,5	3535 SMD	PCB	5100	3000 / 4000 / 6500	64	1691	97	3.1	2	1990
PL13S16L25C	6x12	3535 SMD	PCB	9300	3000 / 4000 / 6500	64	1691	97	3.2	2	1990
PL13S17L15C	7x6,5	3535 SMD	PCB	5950	3000 / 4000 / 6500	64	1971	97	3.5	2	1740
PL13S18L15C	8x6,5	3535 SMD	PCB	6800	3000 / 4000 / 6500	64	2252	97	3.9	2	1550
PL13S19L15C	9x6,5	3535 SMD	PCB	7650	3000 / 4000 / 6500	64	2532	97	4.3	2	1400
PL13S10L15C	10x6,5	3535 SMD	PCB	8500	3000 / 4000 / 6500	64	2813	97	4.7	2	1270
PL13S11L15C	11x6,5	3535 SMD	PCB	9350	3000 / 4000 / 6500	64	3094	97	5.1	2	1160

T5 Floresanlı Tip / T5 Fluorescent Type / Type T5 Fluorescent

Kod Code	Güç Power Puissance (W)	Ampul Tipi Lamp Type Type De Lamp.	Duy Tipi Socket Type Type De Douille	Işık Akısı Lum. Flux Flux Lum. (lm)	Akım Current Courant (A)	Ölçüler Dimensions (mm)			Ağırlık Weight Poids (kg)	Ambalaj Adedi Packing Quantity Colisage	Adet/20" Konteyner Pcs./20" Container Pcs./20" Conteneur
						a	l	h			
P513S114C	1x14	T16(T5)	G5	1200	0.08	64	581	97	1.6	2	4560
P513S124C	1x24	T16(T5)	G5	1750	0.12	64	581	97	1.6	2	4560
P513S121C	1x21	T16(T5)	G5	1900	0.11	64	881	97	2.2	2	3380
P513S128C	1x28	T16(T5)	G5	2600	0.14	64	1181	97	2.8	2	2690
P513S154C	1x54	T16(T5)	G5	4450	0.26	64	1181	97	3.4	2	2690
P513S135C	1x35	T16(T5)	G5	3300	0.17	64	1481	97	3.4	2	2230
P513S149C	1x49	T16(T5)	G5	4300	0.24	64	1481	97	3.4	2	2230
P513S180C	1x80	T16(T5)	G5	6150	0.38	64	1481	97	3.4	2	2230



V / Hz 220 - 240 / 50 - 60

Opsiyonlar	Options	Options
DİM edilebilir elektronik balast yada konvertör. LED'li modeller için acil durum kit.	Dimmable electronic ballast or convertor. Emergency kit for models with LED	Ballast électronique dimmable ou converteur. Kit d'urgence pour les modèles LED.

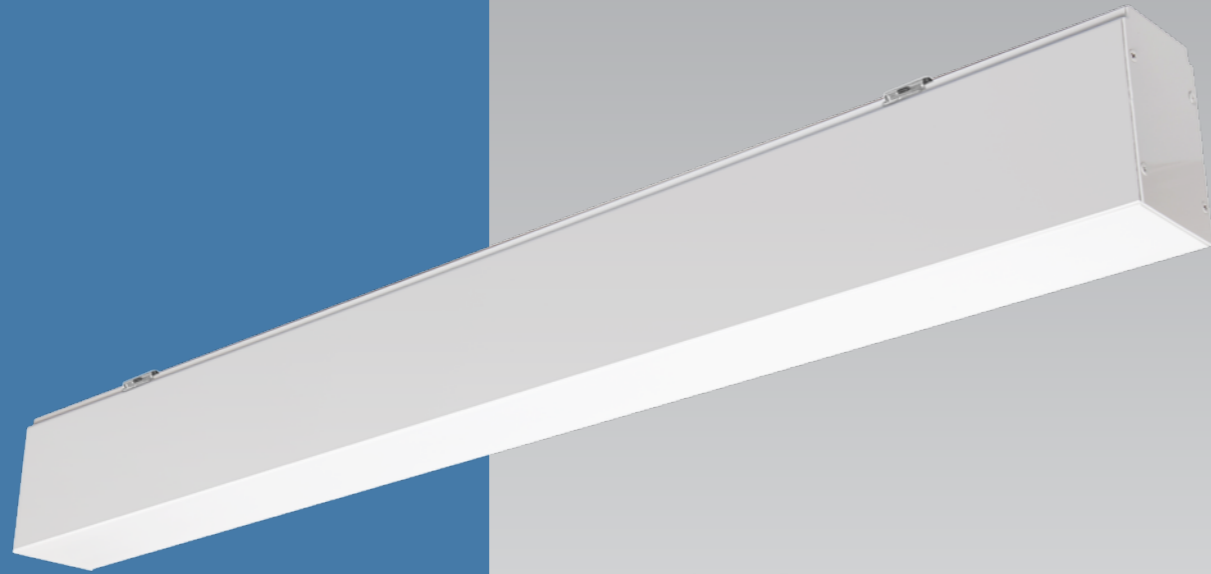

VEGA SLIM

Renk Seçenekleri
Color Options
Options de Couleur



T16 (T5)

Sıva Üstü Tek Sıralı Difüzörlü
Aydınlatma Armatürleri

Surface Mounted Single Line Lighting

Fixtures with Diffuser

Luminaires Apparents Avec
Diffuseur - 1 Ligne

UYGULAMA ALANLARI

Alışveriş Merkezleri
Marketler
Ofisler
Toplantı odaları
Mağazalar
Hastaneler
Okullar
Koridorlar

APPLICATION AREAS

Shopping Malls
Supermarkets
Offices
Meeting rooms
Stores
Hospitals
Schools
Corridors

DOMAINES D'UTILISATION

Centres Commerciaux
Supermarchés
Bureaux
Salles de Réunion
Magasins
Hopitaux
Ecoles
Coulors

GÖVDE

Gümüş, beyaz ve siyah renkli, zarif tasarıma sahip, saten eloksallı kaplamalı alüminyum.

DİFÜZÖR

UV korumalı PC difüzör

BALAST

ENEC standartlarına uygun, uzun ömürlü sabit ışık akısına sahip, düşük enerji kayıplı (EEI=A2) elektronik balast.

BODY

Anodized aluminum with satin finishing, elegant design with white, black and silver color.

DIFFUSER

UV stabilized PC diffuser.

BALLAST

Electronic ballast with long life, low power loss EEI = A2 and constant flux. Compatible with ENEC standards.

CORPS

Corps en aluminium anodisé, satiné. Design elegant couleur argent, blanc et noir.

DIFFUSEUR

Diffuseur en PC anti UV.

BALLAST

Ballast électronique, conforme aux normes ENEC. Longue vie. Perte de puissance faible (EEI = A2). Flux de lumière régulier.

T5 Floresanlı Tip / T5 Fluorescent Type / Type T5 Fluorescent

Kod Code	Güç Power Puissance (W)	Ampul Tipi Lamp Type Typ. De Lamp.	Duy Tipi Socket Type Type De Douille	Işık Akısı Lum. Flux Flux Lum. (lm)	Akım Current Courant (A)	Ölçüler Dimensions (mm)			Ağırlık Weight Poids (kg)	Ambalaj Adedi Packing Quantity Colisage	Adet/20" Konteyner Pcs./20" Conteneur
						a	l	h			
P513U114C	1x14	T16(T5)	G5	1200	0.08	64	581	97	1.4	2	6650
P513U124C	1x24	T16(T5)	G5	1750	0.12	64	581	97	1.4	2	6650
P513U121C	1x21	T16(T5)	G5	1900	0.11	64	881	97	2.0	2	4650
P513U128C	1x28	T16(T5)	G5	2600	0.14	64	1181	97	2.6	2	3470
P513U154C	1x54	T16(T5)	G5	4450	0.26	64	1181	97	2.6	2	3470
P513U135C	1x35	T16(T5)	G5	3300	0.17	64	1481	97	3.2	2	2770
P513U149C	1x49	T16(T5)	G5	4300	0.24	64	1481	97	3.2	2	2770
P513U180C	1x80	T16(T5)	G5	6150	0.38	64	1481	97	3.2	2	2770

V / Hz 220 - 240 / 50 - 60

Opsiyonlar	Options	Options
DIM edilebilir elektronik balast yada konvertör.	Dimmable electronic ballast or convertor.	Ballast électronique dimmable ou converteur.
LED'li modeller için acil durum kiti.	Emergency kit for models with LED	Kit d'urgence pour les modèles LED.





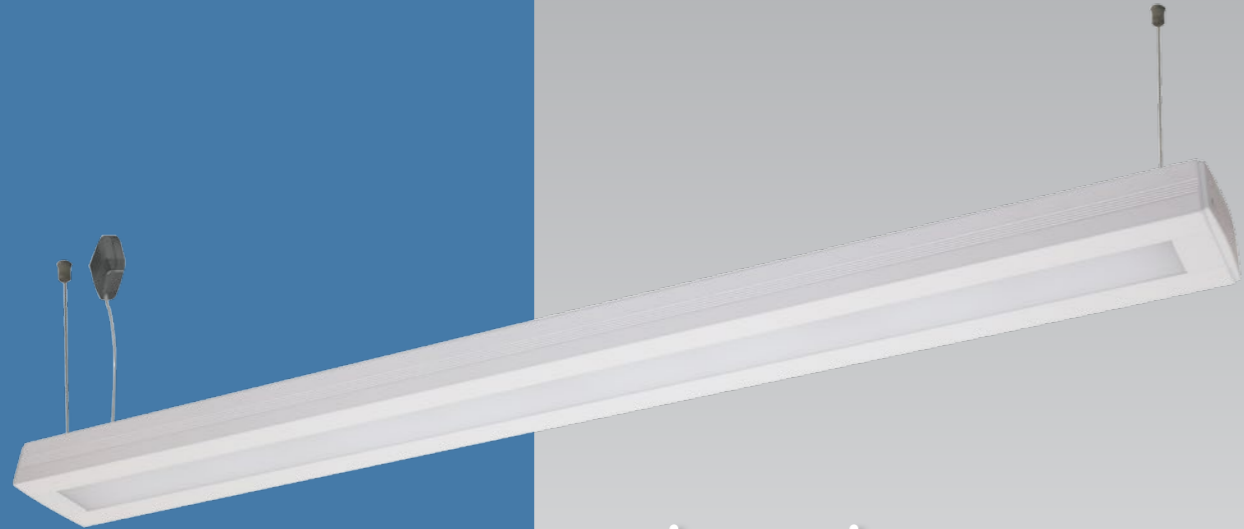

SİMETRİ



Direkt - Endirekt Aydınlatma
Direct - Indirect Lighting
Eclairage Direct - Indirect

Renk Seçenekleri
Color Options
Options de Couleur



LED / T16 (T5)

Sarkıt Akrilik Difüzörlü
Aydınlatma Armatürleri

Suspended Lighting Fixtures With
Acrylic Diffuser

Luminaires Suspendus Avec
Diffuseur Acrylique

UYGULAMA ALANLARI

Alışveriş Merkezleri
Marketler
Ofisler
Toplantı odaları
Mağazalar
Hastaneler
Okullar
Koridorlar

APPLICATION AREAS

Shopping Malls
Supermarkets
Offices
Meeting rooms
Stores
Hospitals
Schools
Corridors

DOMAINES D'UTILISATION

Centres Commerciaux
Supermarchés
Bureaux
Salles de Réunion
Magasins
Hopitaux
Ecoles
Couloirs

GÖVDE

Beyaz, gümüş, siyah renk seçenekleri ile zarif tasarıma sahip alüminyum.

DİFÜZÖR

UV korumalı akrilik difüzör.

BALAST (T5 Modeller İçin)

ENEC standartlarına uygun, uzun ömürlü sabit ışık akısına sahip, düşük enerji kayıplı (EEI=A2) elektronik balast.

KONVERTÖR (LED'li Modeller İçin)

ENEC standartlarına uygun, uzun ömürlü sabit akımlı konvertör.

LED (LED'li Modeller İçin)

50.000 saat ömürlü LUMILEDS / OSRAM / SEOUL marka LED'li LED modülleri.

ASKI

1mm çelik örgü tel ve nikel kaplamalı pirinç parçalardan mamul, askı boyu ayarlanabilir, şeffaf elektrik kablosu ve tavana monte edilen estetik tasarıma sahip elektrik bağlantı kutusu ile birlikte.

BODY

Anodized aluminum with satin finishing. Black, white and silver color options with elegant design.

DİFFÜZÖR

UV stabilized acrylic diffuser.

BALLAST (For T5 Models)

Electronic ballast with long life, low power loss EEI = A2 and constant flux. Compatible with ENEC standards.

CONVERTER (For LED Models)

Long life, low power loss converter with constant current. Compatible with ENEC standards.

LED (For LED Models)

LED modules with 50,000 hours lifetime LUMILEDS / OSRAM / SEOUL brand LEDs.

SUSPENSION

Composed of 1mm steel wire rope and nickel-plated brass components. Suspension height is adjustable. Supplied with transparent electric cord and ceiling mounted electrical junction box with aesthetic design.

CORPS

Corps en aluminium anodisé, satiné. Design élégant. Couleurs blanc, argent et noir disponibles.

DİFFUSEUR

Diffuseur en acrylique. Anti UV.

BALLAST (Pour T5 Modèles)

Ballast électronique, conforme aux normes ENEC. Longue vie. Perte de puissance faible (EEI = A2). Flux de lumière régulier.

CONVERTEUR (Pour Modèles LED)

Convertisseur, conforme aux normes ENEC. Longue vie. Perte de puissance faible avec courant constant.

LED (Pour Modèles LED)

Modules LED - Durée de vie 50.000 heures avec LED de marque LUMILEDS / OSRAM / SEOUL.

SYSTEME DE FIXATION

Composé d'un fil en acier de 1mm, de composants en laiton nickelés. Livré avec un cordon électrique transparent et une boîte de jonction électrique à fixer au plafond. Hauteur de fixation réglable.

LED'li Tip / LED Type / Type LED

Renk Geri Verim Indexi / Color Rendering Index / Indice de Rendu des Couleurs: (CRI): Ra>80

Kod Code	Güç Power Puissance (W)	LED Tipi LED Type Type De LED	LED Modül LED Module Module LED	Işık Akısı Lum. Flux Flux Lum. (lm)	Renk Sıcaklığı Color Temperature Température De Couleur (K)	Ölçüler Dimensions (mm) a l h	Ağırlık Weight Poids (kg)	Ambalaj Adedi Packing Quantity Colisage	Adet/20" Konteyner Pcs./20" Conteneur
PL6S21L15C	3x6,5	3535 SMD	PCB	2550	3000 / 4000 / 6500	104 588 48	1.3	2	5530
PL6S32L15C	5x6,5	3535 SMD	PCB	4250	3000 / 4000 / 6500	104 868 48	1.7	2	4180
PL6S43L15C	7x6,5	3535 SMD	PCB	5950	3000 / 4000 / 6500	104 1149 48	2.1	2	3360
PL6S54L15C	9x6,5	3535 SMD	PCB	7650	3000 / 4000 / 6500	104 1429 48	2.5	2	2810

T5 Floresanlı Tip / T5 Fluorescent Type / Type T5 Fluorescent

Kod Code	Güç Power Puissance (W)	Ampul Tipi Lamp Type Type De Lampe	Duy Tipi Socket Type Type De Douille	Işık Akısı Lum. Flux Flux Lum. (lm)	Akım Current Courant (A)	Ölçüler Dimensions (mm) a l h	Ağırlık Weight Poids (kg)	Ambalaj Adedi Packing Quantity Colisage	Adet/20" Konteyner Pcs./20" Conteneur
P56S114C	1x14	T16(T5)	G5	1200	0.08	104 588 48	1.5	2	5530
P56S124C	1x24	T16(T5)	G5	1750	0.12	104 588 48	1.5	2	5530
P56S121C	1x21	T16(T5)	G5	1900	0.11	104 888 48	1.9	2	4110
P56S128C	1x28	T16(T5)	G5	2600	0.14	104 1188 48	2.4	2	3270
P56S154C	1x54	T16(T5)	G5	4450	0.26	104 1188 48	2.4	2	3270
P56S135C	1x35	T16(T5)	G5	3300	0.17	104 1488 48	2.8	2	2710
P56S149C	1x49	T16(T5)	G5	4300	0.24	104 1488 48	2.8	2	2710
P56S180C	1x80	T16(T5)	G5	6150	0.38	104 1488 48	2.8	2	2710

V / Hz 220 - 240 / 50 - 60

Opsiyonlar	Options	Options
DİM edilebilir elektronik balast yada konvertör.	Dimmable electronic ballast or convertor.	Ballast électronique dimmable ou converteur.
LED'li modeller için acil durum kiti.	Emergency kit for models with LED	Kit d'urgence pour les modèles LED.

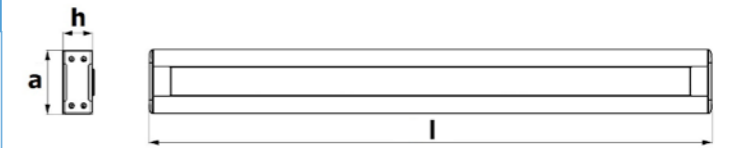



 **pamir**[®]
aydınlatma

FLEKSİ

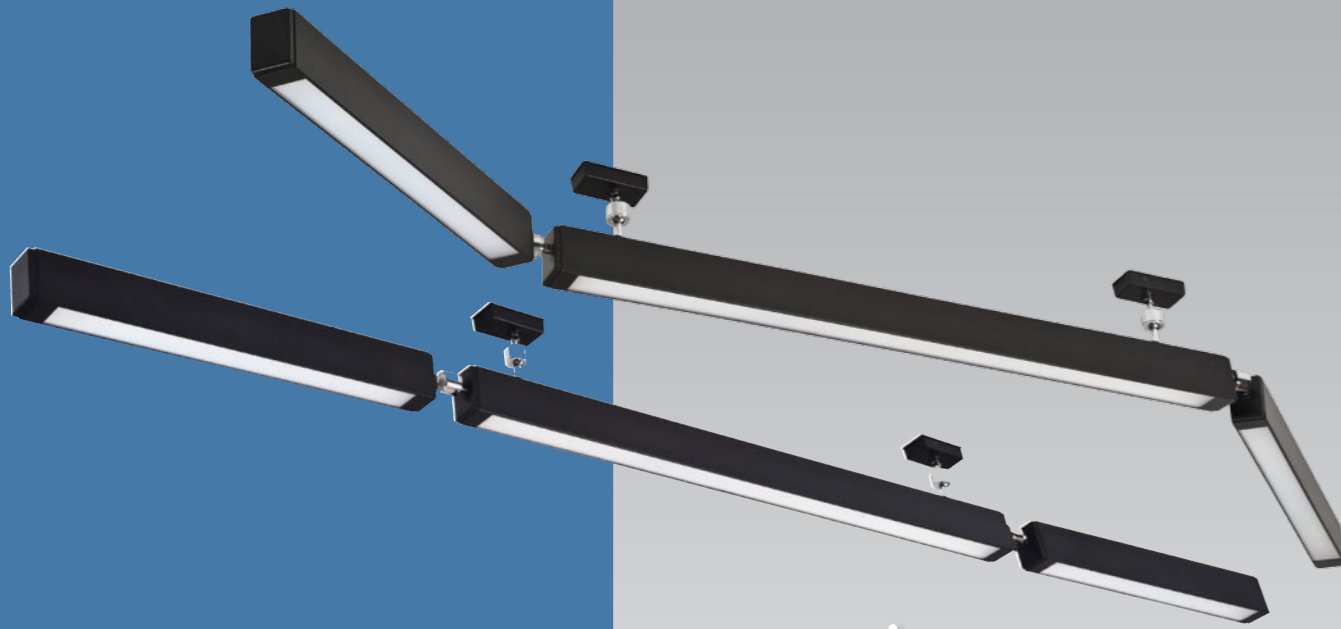

FLEKSİ

Renk Seçenekleri
Color Options
Options de Couleur

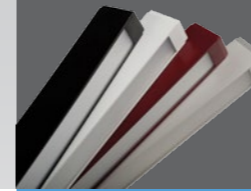

LED / T16 (T5)

Üçlü Mafsallı Buzlu Akrilik Difüzörlü Aydınlatma Armatürleri

Triple Articulated Lighting Fixtures With Frosted Acrylic Diffuser

Luminaires Articulés Trois Éléments Avec Diffuseur Acrylique Givré

UYGULAMA ALANLARI

Alışveriş Merkezleri
Marketler
Ofisler
Toplantı Odaları
Mağazalar
Hastaneler
Okullar
Koridorlar

APPLICATION AREAS

Shopping Malls
Supermarkets
Offices
Meeting rooms
Stores
Hospitals
Schools
Corridors

DOMAINES D'UTILISATION

Centres Commerciaux
Supermarchés
Bureaux
Salles de Réunions
Magasins
Hopitaux
Ecoles
Couloirs

GÖVDE

Beyaz, gümüş, siyah, bordo renk seçenekleri ile zarif tasarıma sahip alüminyum.

DİFÜZÖR

UV korumalı akrilik difüzör.

MAFSAL

Gövdenin parçalarının her yöne 40° dönmesine olanak sağlayan krom kaplamalı çelik mafsallı.

BALAST (T5 Modeller İçin)

ENEC standartlarına uygun, uzun ömürlü sabit ışık akısına sahip, düşük enerji kayıplı (EEI=A2) elektronik balast.

KONVERTÖR (LED'li Modeller İçin)

ENEC standartlarına uygun, uzun ömürlü sabit akımlı konvertör.

LED (LED'li Modeller İçin)

50.000 saat ömürlü LUMILEDS / OSRAM / SEOUL marka LED'li LED modülleri.

BODY

Anodized aluminum with satin finishing. Black, white, silver and red color options with elegant design.

DİFÜZÖR

UV stabilized acrylic diffuser.

JOINT

Chrome plated steel joints, allowing body parts to rotate 40° in all directions.

BALAST (For T5 Models)

Electronic ballast with long life, low power loss EEI = A2 and constant flux. Compatible with ENEC standards.

CONVERTER (For LED Models)

Long life, low power loss converter with constant current. Compatible with ENEC standards.

LED (For LED Models)

LED modules with 50,000 hours lifetime LUMILEDS / OSRAM / SEOUL brand LEDs.

CORPS

Corps en aluminium anodisé, satiné. Design élégant. Couleurs blanc, argent, noir et rouge disponibles.

DİFÜZÖR

Diffuseur en acrylique. Anti UV.

JOINT

Joints en acier chromé, permettant aux parties du corps de tourner à 40° dans toutes les directions.

BALAST (Pour T5 Modèles)

Ballast électronique, conforme aux normes ENEC. Longue vie. Perte de puissance faible (EEI = A2). Flux de lumière régulier.

CONVERTEUR (Pour Modèles LED)

Convertisseur, conforme aux normes ENEC. Longue vie. Perte de puissance faible avec courant constant.

LED (Pour Modèles LED)

Modules LED - Durée de vie 50.000 heures avec LED de marque LUMILEDS / OSRAM / SEOUL.

LED'li Tip / LED Type / Type LED

Renk Geri Verim Indexi / Color Rendering Index / Indice de Rendu des Couleurs: (CRI): Ra>80

Kod Code	Güç Power Puissance (W)	LED Tipi LED Type Type De LED	LED Modül LED Module Module LED	Işık Akısı Lum. Flux Flux Lum. (lm)	Renk Sıcaklığı Color Temperature Température De Couleur (K)	Ölçüler Dimensions (mm)			Ağırlık Weight Poids (kg)	Ambalaj Adedi Packing Quantity Colisage	Adet/20" Konteyner Pcs./20" Container Pcs./20" Conteneur
						a	c	h			
PL3M232L15C	7x6,5	3535 SMD	PCB	5950	3000 / 4000 / 6500	58	2330	87	5.1	2	1600
PL3M232L25C	7x12	3535 SMD	PCB	10850	3000 / 4000 / 6500	58	2330	87	5.1	2	1600
PL3M242L15C	8x6,5	3535 SMD	PCB	6800	3000 / 4000 / 6500	58	2610	87	5.6	2	1430
PL3M242L25C	8x12	3535 SMD	PCB	12400	3000 / 4000 / 6500	58	2610	87	5.6	2	1430
PL3M252L15C	9x6,5	3535 SMD	PCB	7650	3000 / 4000 / 6500	58	2890	87	6.0	2	1310
PL3M252L25C	9x12	3535 SMD	PCB	13950	3000 / 4000 / 6500	58	2890	87	6.0	2	1310

T5 Floresanlı Tip / T5 Fluorescent Type / Type T5 Fluorescent

Kod Code	Güç Power Puissance (W)	Ampul Tipi Lamp Type Type De Lamp.	Duy Tipi Socket Type Type De Douille	Işık Akısı Lum. Flux Flux Lum. (lm)	Akım Current Courant (A)	Ölçüler Dimensions (mm)					Ağırlık Weight Poids (kg)	Ambalaj Adedi Packing Quantity Colisage	Adet/20" Konteyner Pcs./20" Container Pcs./20" Conteneur
						a	b1	b2	c	h			
P53M121214C	1x21 + 2x14	T16(T5)	G5	4300	0.25	58	920	620	2290	87	5.0	2	1620
P53M139224C	1x39 + 2x24	T16(T5)	G5	6600	0.41	58	920	620	2290	87	5.0	2	1620
P53M128214C	1x28 + 2x14	T16(T5)	G5	5000	0.28	58	1220	620	2590	87	5.5	2	1450
P53M154224C	1x54 + 2x24	T16(T5)	G5	7950	0.49	58	1220	620	2590	87	5.5	2	1450
P53M135214C	1x35 + 2x14	T16(T5)	G5	5700	0.31	58	1520	620	2890	87	6.0	2	1310
P53M149224C	1x49 + 2x24	T16(T5)	G5	7800	0.47	58	1520	620	2890	87	6.0	2	1310
P53M180224C	1x80 + 2x24	T16(T5)	G5	9650	0.61	58	1520	620	2890	87	6.0	2	1310

V / Hz 220 - 240 / 50 - 60

Opsiyonlar	Options	Options
DİM edilebilir elektronik balast yada konvertör.	Dimmable electronic ballast or convertor.	Ballast électronique dimmable ou converteur.
LED'li modeller için acil durum kiti.	Emergency kit for models with LED	Kit d'urgence pour les modèles LED.

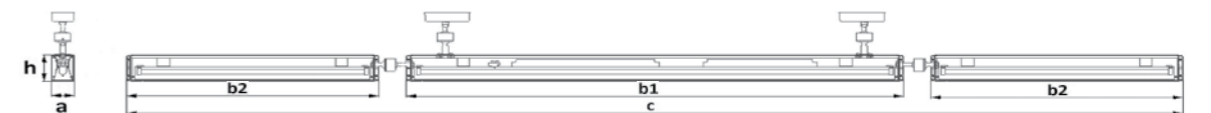

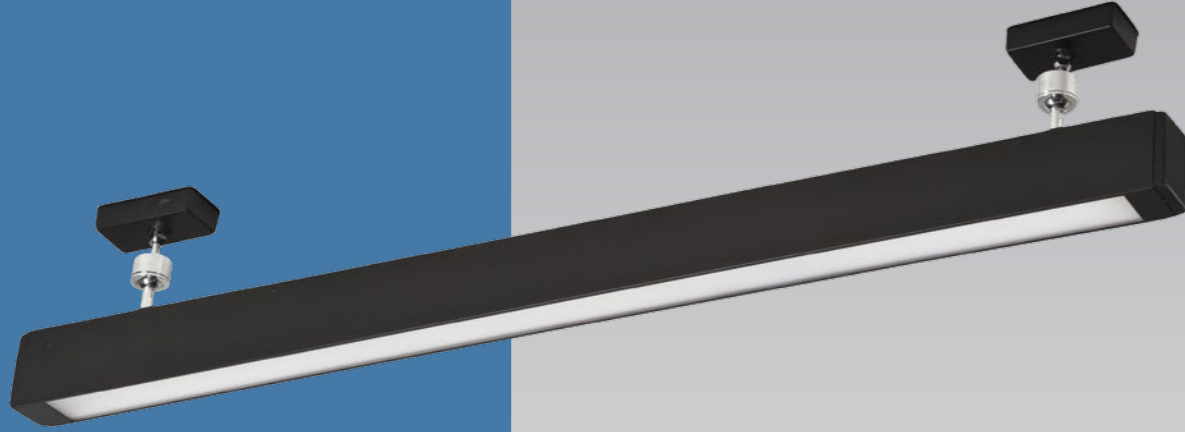

FLEKSİ

Renk Seçenekleri
Color Options
Options de Couleur



LED /T16 (T5)

Tekli Mafsallı Buzlu Akrilik Difüzörlü
Aydınlatma Armatürleri

Single Articulated Lighting Fixtures
With Frosted Acrylic Diffuser

Luminaires Articulés Un Élément
Avec Diffuseur Acrylique Givré

UYGULAMA ALANLARI

Alışveriş Merkezleri
Marketler
Ofisler
Toplantı Odaları
Mağazalar
Hastaneler
Okullar
Koridorlar

APPLICATION AREAS

Shopping Malls
Supermarkets
Offices
Meeting rooms
Stores
Hospitals
Schools
Corridors

DOMAINES D'UTILISATION

Centres Commerciaux
Supermarchés
Bureaux
Salles de Réunions
Magasins
Hopitaux
Ecoles
Coulloirs

GÖVDE

Beyaz, gümüş, siyah, bordo renk seçenekleri ile zarif tasarıma sahip alüminyum.

DİFÜZÖR

UV korumalı akrilik difüzör.

MAFSAL

Gövdenin tavan ile her iki yönde 40° lik açı yapmasına olanak sağlayan krom kaplamalı çelik mafsal.

BALAST (T5 Modeller için)

ENEC standartlarına uygun, uzun ömürlü sabit ışık akısına sahip, düşük enerji kayıplı (EEI=A2) elektronik balast.

KONVERTÖR (LED'li Modeller için)

ENEC standartlarına uygun, uzun ömürlü sabit akımlı konvertör.

LED (LED'li Modeller için)

50.000 saat ömürlü LUMILEDS / OSRAM / SEOUL marka LED'li LED modüller.

BODY

Anodized aluminum with satin finishing. Black, white, silver and red color options with elegant design.

DIFFUSER

UV stabilized acrylic diffuser.

JOINT

Chrome plated steel joints, allowing body to be aligned 40° in both directions.

BALLAST (For T5 Models)

Electronic ballast with long life, low power loss EEI = A2 and constant flux. Compatible with ENEC standards.

CONVERTER (For LED Models)

Long life, low power loss converter with constant current. Compatible with ENEC standards.

LED (For LED Models)

LED modules with 50,000 hours lifetime LUMILEDS / OSRAM / SEOUL brand LEDs.

CORPS

Corps en aluminium anodisé, satiné. Design élégant. Couleurs blanc, argent, noir et rouge disponibles.

DIFFUSEUR

Diffuseur en acrylique. Anti UV.

JOINT

Joints en acier chromé, permettant d'aligner le corps 40° dans les deux sens.

BALLAST (Pour T5 Modèles)

Ballast électronique, conforme aux normes ENEC. Longue vie. Perte de puissance faible (EEI = A2). Flux de lumière régulier.

CONVERTEUR (Pour Modèles LED)

Convertisseur, conforme aux normes ENEC. Longue vie. Perte de puissance faible avec courant constant.

LED (Pour Modèles LED)

Modules LED - Durée de vie 50.000 heures avec LED de marque LUMILEDS / OSRAM / SEOUL.

LED'li Tip / LED Type / Type LED

Renk Geri Verim Indexi / Color Rendering Index / Indice de Rendu des Couleurs: (CRI): Ra>80

Kod Code	Güç Power Puissance (W)	LED Tipi LED Type Type De LED	LED Modül LED Module Module LED	Işık Akısı Lum. Flux Flux Lum. (lm)	Renk Sıcaklığı Color Temperature Température De Couleur (K)	Ölçüler Dimensions (mm)			Ağırlık Weight Poids (kg)	Ambalaj Adedi Packing Quantity Colisage	Adet/20" Konteyner Pcs./20" Conteneur
						a	b	h			
PL3M12L15C	2x6,5	3535 SMD	PCB	1700	3000 / 4000 / 6500	58	640	87	2.1	2	5400
PL3M12L25C	2x12	3535 SMD	PCB	3100	3000 / 4000 / 6500	58	640	87	2.1	2	5400
PL3M13L15C	3x6,5	3535 SMD	PCB	2550	3000 / 4000 / 6500	58	920	87	2.5	2	3600
PL3M13L25C	3x12	3535 SMD	PCB	4650	3000 / 4000 / 6500	58	920	87	2.5	2	3600
PL3M14L15C	4x6,5	3535 SMD	PCB	3400	3000 / 4000 / 6500	58	1200	87	2.9	2	2800
PL3M14L25C	4x12	3535 SMD	PCB	6200	3000 / 4000 / 6500	58	1200	87	2.9	2	2800
PL3M15L15C	5x6,5	3535 SMD	PCB	4250	3000 / 4000 / 6500	58	1480	87	3.4	2	2330
PL3M15L25C	5x12	3535 SMD	PCB	7750	3000 / 4000 / 6500	58	1480	87	3.4	2	2330

T5 Floresanlı Tip / T5 Fluorescent Type / Type T5 Fluorescent

Kod Code	Güç Power Puissance (W)	Ampul Tipi Lamp Type Typ. De Lamp.	Duy Tipi Socket Type Type De Douille	Işık Akısı Lum. Flux Flux Lum. (lm)	Akım Current Courant (A)	Ölçüler Dimensions (mm)			Ağırlık Weight Poids (kg)	Ambalaj Adedi Packing Quantity Colisage	Adet/20" Konteyner Pcs./20" Conteneur
						a	b	h			
P53M114C	1x14	T16(T5)	G5	1200	0.08	58	620	87	2.0	2	5400
P53M124C	1x24	T16(T5)	G5	1750	0.12	58	620	87	2.0	2	5400
P53M121C	1x21	T16(T5)	G5	1900	0.11	58	920	87	2.5	2	3600
P53M128C	1x28	T16(T5)	G5	2600	0.14	58	1220	87	3.0	2	2800
P53M154C	1x54	T16(T5)	G5	4450	0.26	58	1220	87	3.0	2	2800
P53M135C	1x35	T16(T5)	G5	3300	0.17	58	1520	87	3.5	2	2330
P53M149C	1x49	T16(T5)	G5	4300	0.24	58	1520	87	3.5	2	2330
P53M180C	1x80	T16(T5)	G5	6150	0.38	58	1520	87	3.5	2	2330

V / Hz 220 - 240 / 50 - 60

Opsiyonlar	Options	Options
DIM edilebilir elektronik balast yada konvertör.	Dimmable electronic ballast or convertor.	Ballast électronique dimmable ou converteur.
LED'li modeller için acil durum kiti.	Emergency kit for models with LED	Kit d'urgence pour les modèles LED.





FLEKSİ

Renk Seçenekleri
Color Options
Options de Couleur

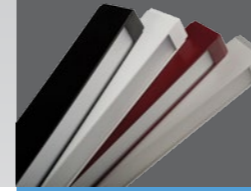

LED /T16 (T5)

Sarkıt Buzlu Akrilik Difüzörlü
Aydınlatma Armatürleri

Suspended Lighting Fixtures With
Frosted Acrylic Diffuser

Luminaire Suspendus Avec
Diffuseur Acrylique Givré

UYGULAMA ALANLARI

Alışveriş Merkezleri
Marketler
Ofisler
Toplantı Odaları
Mağazalar
Hastaneler
Okullar
Koridorlar

APPLICATION AREAS

Shopping Malls
Supermarkets
Offices
Meeting rooms
Stores
Hospitals
Schools
Corridors

DOMAINES D'UTILISATION

Centres Commerciaux
Supermarchés
Bureaux
Salles de Réunions
Magasins
Hopitaux
Ecoles
Couloirs

GÖVDE

Beyaz, gümüş, siyah, bordo renk seçenekleri ile zarif tasarıma sahip alüminyum.

DİFÜZÖR

UV korumalı akrilik difüzör.

BALAST (T5 Modelleri İçin)

ENEC standartlarına uygun, uzun ömürlü sabit ışık akısına sahip, düşük enerji kayıplı (EEI=A2) elektronik balast.

KONVERTÖR (LED'li Modeller İçin)

ENEC standartlarına uygun, uzun ömürlü sabit akımlı konvertör.

LED (LED'li Modeller İçin)

50.000 saat ömürlü LUMILEDS / OSRAM / SEOUL marka LED'li LED modülleri.

ASKI

1mm çelik örgü tel ve nikel kaplamalı piriñ parçalardan mamul, askı boyu ayarlanabilir, şeffaf elektrik kablosu ve tavana monte edilen estetik tasarıma sahip elektrik bağlantı kutusu ile birlikte.

BODY

Anodized aluminum with satin finishing. Black, white, silver and red color options with elegant design.

DIFFUSER

UV stabilized acrylic diffuser.

BALLAST (For T5 Models)

Electronic ballast with long life, low power loss EEI = A2 and constant flux. Compatible with ENEC standards.

CONVERTER (For LED Models)

Long life, low power loss converter with constant current. Compatible with ENEC standards.

LED (For LED Models)

LED modules with 50,000 hours lifetime LUMILEDS / OSRAM / SEOUL brand LEDs.

SUSPENSION

Composed of 1mm steel wire rope and nickel-plated brass components. Suspension height is adjustable. Supplied with transparent electric cord and ceiling mounted electrical junction box with aesthetic design.

CORPS

Corps en aluminium anodisé, satiné. Design élégant. Couleurs blanc, argent, noir et rouge disponibles.

DIFFUSEUR

Diffuseur en acrylique. Anti UV.

BALLAST (Pour T5 Modèles)

Ballast électronique, conforme aux normes ENEC. Longue vie. Perte de puissance faible (EEI = A2). Flux de lumière régulier.

CONVERTEUR (Pour Modèles LED)

Convertisseur, conforme aux normes ENEC. Longue vie. Perte de puissance faible avec courant constant.

LED (Pour Modèles LED)

Modules LED - Durée de vie 50.000 heures avec LED de marque LUMILEDS / OSRAM / SEOUL.

SYSTEME DE FIXATION

Composé d'un fil en acier de 1mm, de composants en laiton nickelés. Livré avec un cordon électrique transparent et une boîte de jonction électrique à fixer au plafond. Hauteur de fixation réglable.

LED'li Tip / LED Type / Type LED

Renk Geri Verim Indexi / Color Rendering Index / Indice de Rendu des Couleurs: (CRI): Ra>80

Kod Code	Güç Power Puissance (W)	LED Tipi LED Type Type De LED	LED Modül LED Module Module LED	Işık Akısı Lum. Flux Flux Lum. (lm)	Renk Sıcaklığı Color Temperature Température De Couleur (K)	Ölçüler Dimensions (mm)			Ağırlık Weight Poids (kg)	Ambalaj Adedi Packing Quantity Colisage	Adet/20" Konteyner Pcs./20" Container Pcs./20" Conteneur
						a	b	h			
PL3S12L15C	2x6,5	3535 SMD	PCB	1700	3000 / 4000 / 6500	58	640	87	1.6	2	5400
PL3S12L25C	2x12	3535 SMD	PCB	3100	3000 / 4000 / 6500	58	640	87	1.6	2	5400
PL3S13L15C	3x6,5	3535 SMD	PCB	2550	3000 / 4000 / 6500	58	920	87	2.0	2	3600
PL3S13L25C	3x12	3535 SMD	PCB	4650	3000 / 4000 / 6500	58	920	87	2.0	2	3600
PL3S14L15C	4x6,5	3535 SMD	PCB	3400	3000 / 4000 / 6500	58	1200	87	2.4	2	2800
PL3S14L25C	4x12	3535 SMD	PCB	6200	3000 / 4000 / 6500	58	1200	87	2.4	2	2800
PL3S15L15C	5x6,5	3535 SMD	PCB	4250	3000 / 4000 / 6500	58	1480	87	2.9	2	2330
PL3S15L25C	5x12	3535 SMD	PCB	7750	3000 / 4000 / 6500	58	1480	87	2.9	2	2330

T5 Floresanlı Tip / T5 Fluorescent Type / Type T5 Fluorescent

Kod Code	Güç Power Puissance (W)	Ampul Tipi Lamp Type Typ. De Lampe.	Duy Tipi Socket Type Type De Douille	Işık Akısı Lum. Flux Flux Lum. (lm)	Akım Current Courant (A)	Ölçüler Dimensions (mm)			Ağırlık Weight Poids (kg)	Ambalaj Adedi Packing Quantity Colisage	Adet/20" Konteyner Pcs./20" Container Pcs./20" Conteneur
						a	b	h			
P53S114C	1x14	T16(T5)	G5	1200	0.08	58	620	87	1.7	2	5400
P53S124C	1x24	T16(T5)	G5	1750	0.12	58	620	87	1.7	2	5400
P53S121C	1x21	T16(T5)	G5	1900	0.11	58	920	87	2.2	2	3600
P53S128C	1x28	T16(T5)	G5	2600	0.14	58	1220	87	2.7	2	2800
P53S154C	1x54	T16(T5)	G5	4450	0.26	58	1220	87	2.7	2	2800
P53S135C	1x35	T16(T5)	G5	3300	0.17	58	1520	87	3.2	2	2330
P53S149C	1x49	T16(T5)	G5	4300	0.24	58	1520	87	3.2	2	2330
P53S180C	1x80	T16(T5)	G5	6150	0.38	58	1520	87	3.2	2	2330

V / Hz 220 - 240 / 50 - 60

Opsiyonlar	Options	Options
DIM edilebilir elektronik balast yada konvertör.	Dimmable electronic ballast or convertor.	Ballast électronique dimmable ou converteur.
LED'li modeller için acil durum kiti.	Emergency kit for models with LED	Kit d'urgence pour les modèles LED.



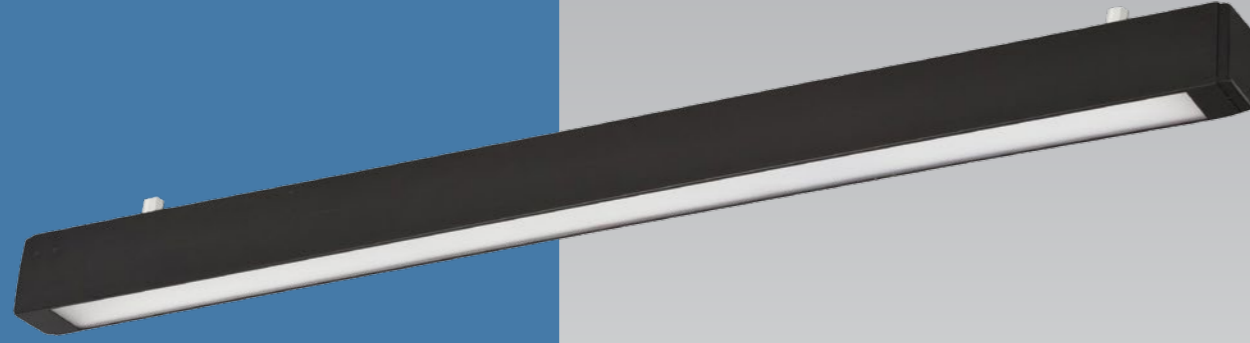

FLEKSİ

Renk Seçenekleri
Color Options
Options de Couleur



LED /T16 (T5)

Sıva Üstü Buzlu Akrilik Difüzörlü
Aydınlatma Armatürleri

Surface Mounted Lighting Fixtures
With Frosted Acrylic Diffuser

Luminaire Apparents Avec
Diffuseur Acrylique Givré

UYGULAMA ALANLARI

Alışveriş Merkezleri
Marketler
Ofisler
Toplantı Odaları
Mağazalar
Hastaneler
Okullar
Koridorlar

APPLICATION AREAS

Shopping Malls
Supermarkets
Offices
Meeting rooms
Stores
Hospitals
Schools
Corridors

DOMAINES D'UTILISATION

Centres Commerciaux
Supermarchés
Bureaux
Salles de Réunions
Magasins
Hopitaux
Ecoles
Couloirs

GÖVDE

Beyaz, gümüş, siyah, bordo renk seçenekleri ile zarif tasarıma sahip alüminyum.

DİFÜZÖR

UV korumalı akrilik difüzör.

BALAST (T5 Modeller İçin)

ENEC standartlarına uygun, uzun ömürlü sabit ışık akısına sahip, düşük enerji kayıplı (EEI=A2) elektronik balast.

KONVERTÖR (LED'li Modeller İçin)

ENEC standartlarına uygun, uzun ömürlü sabit akımlı konvertör.

LED (LED'li Modeller İçin)

50.000 saat ömürlü LUMILEDS / OSRAM / SEOUL marka LED'li LED modüller.

BODY

Anodized aluminum with satin finishing. Black, white, silver and red color options with elegant design.

DIFFUSER

UV stabilized acrylic diffuser.

BALLAST (For T5 Models)

Electronic ballast with long life, low power loss EEI = A2 and constant flux. Compatible with ENEC standards.

CONVERTER (For LED Models)

Long life, low power loss converter with constant current. Compatible with ENEC standards.

LED (For LED Models)

LED modules with 50,000 hours lifetime LUMILEDS / OSRAM / SEOUL brand LEDs.

CORPS

Corps en aluminium anodisé, satiné. Design élégant. Couleurs blanc, argent, noir et rouge disponibles.

DIFFUSEUR

Diffuseur en acrylique. Anti UV.

BALLAST (Pour T5 Modèles)

Ballast électronique, conforme aux normes ENEC. Longue vie. Perte de puissance faible (EEI = A2). Flux de lumière régulier.

CONVERTEUR (Pour Modèles LED)

Convertisseur, conforme aux normes ENEC. Longue vie. Perte de puissance faible avec courant constant.

LED (Pour Modèles LED)

Modules LED – Durée de vie 50.000 heures avec LED de marque LUMILEDS / OSRAM / SEOUL.

LED'li Tip / LED Type / Type LED

Renk Geri Verim Indexi / Color Rendering Index / Indice de Rendu des Couleurs: (CRI): Ra>80

Kod Code	Güç Power Puissance (W)	LED Tipi LED Type Type De LED	LED Modül LED Module Module LED	Işık Akısı Lum. Flux Flux Lum. (lm)	Renk Sıcaklığı Color Temperature Température De Couleur (K)	Ölçüler Dimensions (mm)			Ağırlık Weight Poids (kg)	Ambalaj Adedi Packing Quantity Colisage	Adet/20" Konteyner Pcs./20" Container Pcs./20" Conteneur
						a	b	h			
PL3U12L15C	2x6,5	3535 SMD	PCB	1700	3000 / 4000 / 6500	58	640	87	1.9	2	6800
PL3U12L25C	2x12	3535 SMD	PCB	3100	3000 / 4000 / 6500	58	640	87	1.9	2	6800
PL3U13L15C	3x6,5	3535 SMD	PCB	2550	3000 / 4000 / 6500	58	920	87	2.2	2	4750
PL3U13L25C	3x12	3535 SMD	PCB	4650	3000 / 4000 / 6500	58	920	87	2.2	2	4750
PL3U14L15C	4x6,5	3535 SMD	PCB	3400	3000 / 4000 / 6500	58	1200	87	2.7	2	3500
PL3U14L25C	4x12	3535 SMD	PCB	6200	3000 / 4000 / 6500	58	1200	87	2.7	2	3500
PL3U15L15C	5x6,5	3535 SMD	PCB	4250	3000 / 4000 / 6500	58	1480	87	3.2	2	2800
PL3U15L25C	5x12	3535 SMD	PCB	7750	3000 / 4000 / 6500	58	1480	87	3.2	2	2800

T5 Floresanlı Tip / T5 Fluorescent Type / Type T5 Fluorescent

Kod Code	Güç Power Puissance (W)	Ampul Tipi Lamp Type Typ. De Lamp.	Duy Tipi Socket Type Type De Douille	Işık Akısı Lum. Flux Flux Lum. (lm)	Akım Current Courant (A)	Ölçüler Dimensions (mm)			Ağırlık Weight Poids (kg)	Ambalaj Adedi Packing Quantity Colisage	Adet/20" Konteyner Pcs./20" Container Pcs./20" Conteneur
						a	b	h			
P53U114C	1x14	T16(T5)	G5	1200	0.08	58	620	87	1.5	2	6800
P53U124C	1x24	T16(T5)	G5	1750	0.12	58	620	87	1.5	2	6800
P53U121C	1x21	T16(T5)	G5	1900	0.11	58	920	87	2.0	2	4750
P53U128C	1x28	T16(T5)	G5	2600	0.14	58	1220	87	2.5	2	3500
P53U154C	1x54	T16(T5)	G5	4450	0.26	58	1220	87	2.5	2	3500
P53U135C	1x35	T16(T5)	G5	3300	0.17	58	1520	87	3.0	2	2800
P53U149C	1x49	T16(T5)	G5	4300	0.24	58	1520	87	3.0	2	2800
P53U180C	1x80	T16(T5)	G5	6150	0.38	58	1520	87	3.0	2	2800

V / Hz 220 - 240 / 50 - 60

Opsiyonlar	Options	Options
DIM edilebilir elektronik balast yada konvertör.	Dimmable electronic ballast or convertor.	Ballast électronique dimmable ou converteur.
LED'li modeller için acil durum kiti.	Emergency kit for models with LED	Kit d'urgence pour les modèles LED.





 pamir[®]
aydınlık

ELEGANT

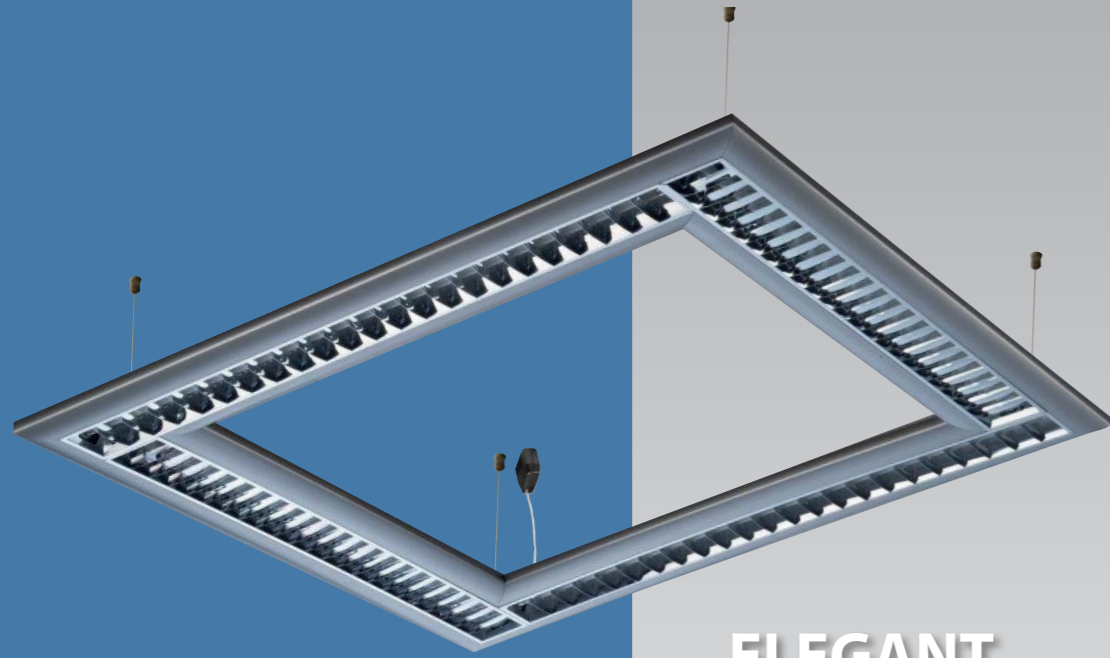

ELEGANT



Direkt - Endirekt Aydınlatma
Direct - Indirect Lighting
Eclairage Direct - Indirect

Renk Seçenekleri
Color Options
Options de Couleur

Gümüş
Silver
Argent

Bronz
Bronze



T16 (T5)

Kare Sarkıt Alüminyum Reflektörlü Aydınlatma Armatürleri

Suspended Square Lighting Fixtures With Aluminum Reflector

Luminaire Carrés Suspendus Avec Reflecteur en Aluminium

UYGULAMA ALANLARI

Ofisler
Toplantı Odaları
Mağazalar
Hastaneler
Okullar
Koridorlar

APPLICATION AREAS

Offices
Meeting rooms
Stores
Hospitals
Schools
Corridors

DOMAINES D'UTILISATION

Bureaux
Salles de Réunion
Magasins
Hopitaux
Ecoles
Coulors

GÖVDE

Bronz ve Gümüş renk seçeneği, ince (37mm) zarif tasarıma sahip, saten eloksallı kaplamalı alüminyum.

REFLEKTÖR

%99 Safılıkta, ayna yüzeyi parlaklığında ve yüksek yansıtma performansına sahip ışığın verimli bir şekilde dağılımını sağlayan zarif tasarımlı eloksallı kaplamalı alüminyum.

ARKA YÜZ DİFÜZÖRLER

UV korumalı akrilik prizmatik difüzör.

BALAST

ENEC standartlarına uygun, uzun ömürlü sabit ışık akısına sahip, düşük enerji kayıplı (EEI=A2) elektronik balast

ASKI

1mm çelik örgü tel ve nikel kaplamalı prınç parçalardan mamul, askı boyu ayarlanabilir, şeffaf elektrik kablosu ve tavana monte edilen estetik tasarıma sahip elektrik bağlantı kutusu ile birlikte.

BODY

Anodized aluminum with satin finishing. Bronze and silver color options with thin (37mm) elegant design.

REFLECTOR

Anodized aluminum with %99,9 purity and with mirror like glossy surface having high reflection performance. Elegant design enables the efficient distribution of the light to the targeted area.

BACK SIDE DIFFUSERS

UV stabilized acrylic prismatic diffuser.

BALLAST

Electronic ballast with long life, low power loss EEI = A2 and constant flux. Compatible with ENEC standards.

SUSPENSION

Composed of 1mm steel wire rope and nickel-plated brass components. Suspension height is adjustable. Supplied with transparent electric cord and ceiling mounted electrical junction box with aesthetic design.

CORPS

En aluminium anodisé, satiné. Design élégant. Couleurs argent et bronze disponibles. Epaisseur : 37mm.

REFLECTEUR

En aluminium anodisé a 99,99% de pureté et avec une surface brillante comme un miroir, assurant un niveau élevé de réflexion. Design élégant. Permet une répartition efficace de la lumière vers l'endroit ciblé.

DIFFUSEURS DE LA FACE ARRIERE

Diffuseur prismatique en acrylique. Anti UV.

BALLAST

Ballast électronique, conforme aux normes ENEC. Longue vie. Perte de puissance faible (EEI=A2). Flux de lumière régulier.

SYSTEME DE FIXATION

Composé d'un câble en acier de 1 mm, de composants en laiton nickelés. Livré avec un cordon électrique transparent et une boîte de jonction électrique à fixer au plafond.

Kod Code	Güç Power Puissance (W)	Ampul Tipi Lamp Type Typ. De Lamp.	Duy Tipi Socket Type Type De Douille	Işık Akısı Lum. Flux Flux Lum. (lm)	Akım Current Courant (A)	Ölçüler Dimensions (mm)			Ağırlık Weight Poids (kg)	Ambalaj Adedi Packing Quantity Colisage	Adet/20" Konteyner Pcs./20" Conteneur
						a	b	h			
P51SK414A	4x14	T16(T5)	G5	4800	0.28	730	730	37	3.2	1	1040
P51SK421A	4x21	T16(T5)	G5	7600	0.40	1030	1030	37	6.2	1	530
P51SK428A	4x28	T16(T5)	G5	10400	0.52	1330	1330	37	9.2	1	320
P51SK214221A	2x14 + 2x21	T16(T5)	G5	6200	0.34	730	1030	37	4.8	1	740
P51SK214228A	2x14 + 2x28	T16(T5)	G5	7600	0.40	730	1330	37	6.2	1	580
P51SK221228A	2x21 + 2x28	T16(T5)	G5	9000	0.46	1030	1330	37	7.6	1	410

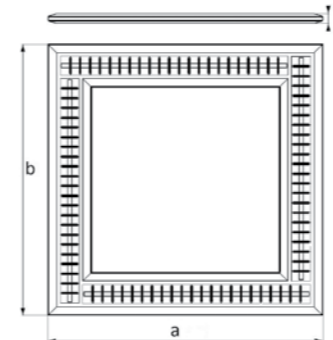

V / Hz 220 - 240 / 50 - 60

Opsiyonlar	Options	Options
DIM edilebilir elektronik balast.	Dimmable electronic ballast.	Ballast électronique dimmable.



ELEGANT

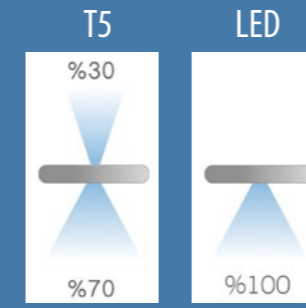

Renk Seçenekleri
Color Options
Options de Couleur

Gümüş
Silver
Argent

Bronz
Bronze



LED / T16 (T5)

Kare Sarkıt Prizmatik
Difüzörlü Aydınlatma Armatürleri

Suspended Square Lighting
Fixtures With Prismatic Diffuser

Luminaire Carrés Suspendus
Avec Diffuseur Prismatique

UYGULAMA ALANLARI

Ofisler
Toplantı Odaları
Mağazalar
Hastaneler
Okullar
Koridorlar

APPLICATION AREAS

Offices
Meeting rooms
Stores
Hospitals
Schools
Corridors

DOMAINES D'UTILISATION

Bureaux
Salles de Réunion
Magasins
Hopitaux
Ecoles
Couloirs

GÖVDE

Bronz ve Gümüş renk seçenekli, ince (37mm) zarif tasarıma sahip, saten eloksallı kaplamalı alüminyum.

ÖN VE ARKA YÜZ DİFÜZÖRLER

UV korumalı akrilik prizmatik difüzör.

BALAST (T5 Modeller İçin)

ENEC standartlarına uygun, uzun ömürlü sabit ışık akısına sahip, düşük enerji kayıplı (EEI=A2) elektronik balast.

KONVERTÖR (LED'li Modeller İçin)

ENEC standartlarına uygun, uzun ömürlü sabit akımlı konvertör.

LED (LED'li Modeller İçin)

50.000 saat ömürlü LUMILEDS / OSRAM / SEOUL marka LED'li LED modüller.

ASKI

1mm çelik örgü tel ve nikel kaplamalı prınç parçalardan mamul, askı boyu ayarlanabilir, şeffaf elektrik kablosu ve tavana monte edilen estetik tasarıma sahip elektrik bağlantı kutusu ile birlikte.

BODY

Anodized aluminum with satin finishing. Bronze and silver color options with thin (37mm) elegant design.

BACK AND FRONT SIDES DIFFUSERS

UV stabilized acrylic prismatic diffuser.

BALLAST (For T5 Models)

Electronic ballast with long life, low power loss EEI = A2 and constant flux. Compatible with ENEC standards.

CONVERTER (For LED Models)

Long life, low power loss converter with constant current. Compatible with ENEC standards.

LED (For LED Models)

LED modules with 50,000 hours lifetime LUMILEDS / OSRAM / SEOUL brand LEDs.

SUSPENSION

Composed of 1mm steel wire rope and nickel-plated brass components. Suspension height is adjustable. Supplied with transparent electric cord and ceiling mounted electrical junction box with aesthetic design.

CORPS

Corps en aluminium anodisé, satiné. Design élégant. Couleurs argent et bronze disponibles. Epaisseur 37 mm.

DIFFUSEURS AVANT ET ARRIERE

Diffuseur prismatique en acrylique. Anti UV.

BALLAST (Pour T5 Modèles)

Ballast électronique, conforme aux normes ENEC. Longue vie. Perte de puissance faible (EEI = A2). Flux de lumière régulier.

CONVERTEUR (Pour Modèles LED)

Convertisseur, conforme aux normes ENEC. Longue vie. Perte de puissance faible avec courant constant.

LED (Pour Modèles LED)

Modules LED - Durée de vie 50.000 heures avec LED de marque LUMILEDS / OSRAM / SEOUL.

SYSTEME DE FIXATION

Composé d'un câble en acier de 1 mm, de composants en laiton nickelés. Livré avec un cordon électrique transparent et une boîte de jonction électrique à fixer au plafond.

LED'li Tip / LED Type / Type LED

Renk Geri Verim Indexi / Color Rendering Index / Indice de Rendu des Couleurs: (CRI): Ra>80

Kod Code	Güç Power Puissance (W)	LED Tipi LED Type Type De LED	LED Modül LED Module Module LED	Işık Akısı Lum. Flux Flux Lum. (lm)	Renk Sıcaklığı Color Temperature Température De Couleur (K)	Ölçüler Dimensions (mm)			Ağırlık Weight Poids (kg)	Ambalaj Adedi Packing Quantity Colisage	Adet/20" Konteyner Pcs./20" Container Pcs./20" Conteneur
						a	b	h			
PL15K22L15C	8x6,5	3535 SMD	PCB	6800	3000 / 4000 / 6500	806	806	37	5.9	1	850
PL15K33L15C	12x6,5	3535 SMD	PCB	10200	3000 / 4000 / 6500	1086	1086	37	9.3	1	480
PL15K44L15C	16x6,5	3535 SMD	PCB	13600	3000 / 4000 / 6500	1366	1366	37	12.9	1	300
PL15K23L15C	10x6,5	3535 SMD	PCB	8500	3000 / 4000 / 6500	806	1086	37	7.9	1	630
PL15K24L15C	12x6,5	3535 SMD	PCB	10200	3000 / 4000 / 6500	806	1366	37	9.7	1	510
PL15K34L15C	14x6,5	3535 SMD	PCB	11900	3000 / 4000 / 6500	1086	1366	37	11.1	1	380

T5 Floresanlı Tip / T5 Fluorescent Type / Type T5 Fluorescent

Kod Code	Güç Power Puissance (W)	Ampul Tipi Lamp Type Typ. De Lamp.	Duy Tipi Socket Type Type De Douille	Işık Akısı Lum. Flux Flux Lum. (lm)	Akım Current Courant (A)	Ölçüler Dimensions (mm)			Ağırlık Weight Poids (kg)	Ambalaj Adedi Packing Quantity Colisage	Adet/20" Konteyner Pcs./20" Container Pcs./20" Conteneur
						a	b	h			
P515K414C	4x14	T16(T5)	G5	4800	0.28	730	730	37	4.8	1	1040
P515K421C	4x21	T16(T5)	G5	7600	0.40	1030	1030	37	8.4	1	530
P515K428C	4x28	T16(T5)	G5	10400	0.52	1330	1330	37	12.1	1	320
P515K214221C	2x14 + 2x21	T16(T5)	G5	6200	0.34	730	1030	37	6.7	1	740
P515K214228C	2x14 + 2x28	T16(T5)	G5	7600	0.40	730	1330	37	8.5	1	580
P515K221228C	2x21 + 2x28	T16(T5)	G5	9000	0.46	1030	1330	37	10.3	1	410

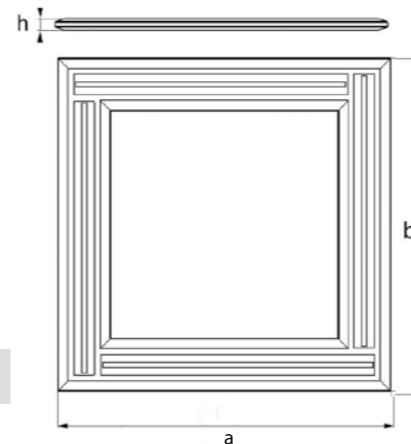

V / Hz 220 - 240 / 50 - 60

Opsiyonlar	Options	Options
DIM edilebilir elektronik balast yada konvertör.	Dimmable electronic ballast or convertor.	Ballast électronique dimmable ou converteur.
LED'li modeller için acil durum kiti.	Emergency kit for models with LED	Kit d'urgence pour les modèles LED.

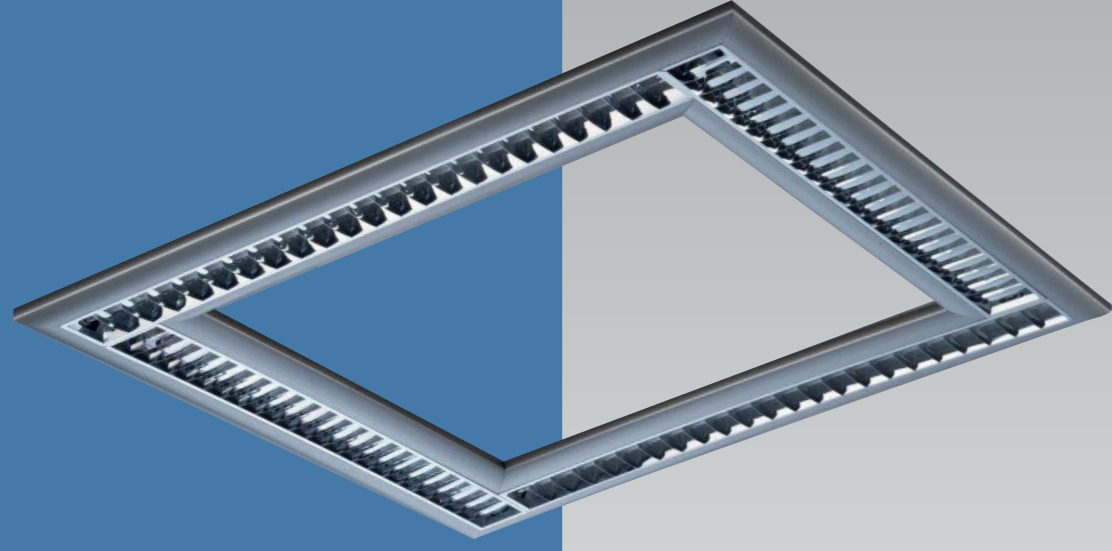

ELEGANT

Renk Seçenekleri
Color Options
Options de Couleur

Gümüş
Silver
Argent

Bronz
Bronze



T16 (T5)

Kare Sıva Üstü Alüminyum Reflektörlü Aydınlatma Armatürleri

Surface Mounted Square Lighting Fixtures With Aluminum Reflector

Luminares Carrés Apparents Avec Reflecteur en Aluminium

UYGULAMA ALANLARI

Ofisler
Toplantı Odaları
Mağazalar
Hastaneler
Okullar
Koridorlar

APPLICATION AREAS

Offices
Meeting rooms
Stores
Hospitals
Schools
Corridors

DOMAINES D'UTILISATION

Bureaux
Salles de Réunion
Magasins
Hopitaux
Ecoles
Couloirs

Kod Code	Güç Power Puissance (W)	Ampul Tipi Lamp Type Typ. De Lamp.	Duy Tipi Socket Type Type De Douille	Işık Akısı Lum. Flux Flux Lum. (lm)	Akım Current Courant (A)	Ölçüler Dimensions (mm)			Ağırlık Weight Poids (kg)	Ambalaj Adedi Packing Quantity Colisage	Adet/20" Konteyner Pcs./20" Container
						a	b	h			
P51UK414A	4x14	T16(T5)	G5	4800	0.28	730	730	37	3.4	1	1040
P51UK421A	4x21	T16(T5)	G5	7600	0.40	1030	1030	37	6.4	1	530
P51UK428A	4x28	T16(T5)	G5	10400	0.52	1330	1330	37	9.4	1	320
P51UK214221A	2x14 + 2x21	T16(T5)	G5	6200	0.34	730	1030	37	5.0	1	740
P51UK214228A	2x14 + 2x28	T16(T5)	G5	7600	0.40	730	1330	37	6.4	1	580
P51UK221228A	2x21 + 2x28	T16(T5)	G5	9000	0.46	1030	1330	37	7.8	1	410

V / Hz 220 - 240 / 50 - 60

Opsiyonlar	Options	Options
DIM edilebilir elektronik balast.	Dimmable electronic ballast.	Ballast électronique dimmable.

GÖVDE

Bronz ve Gümüş renk seçeneği, ince (37mm) zarif tasarıma sahip, saten eloksallı alüminyum.

REFLEKTÖR

%99,9 Safılıkta, ayna yüzeyi parlaklığında ve yüksek yansıtma performansına sahip ışığın verimli bir şekilde dağılımını sağlayan zarif tasarımlı eloksallı alüminyum.

BALAST

ENEC standartlarına uygun, uzun ömürlü sabit ışık akısına sahip, düşük enerji kayıplı (EEI=A2) elektronik balast

BODY

Anodized aluminum with satin finishing. Bronze and silver color options with thin (37mm) elegant design.

REFLECTOR

Anodized aluminum with %99,9 purity and with mirror like glossy surface having high reflection performance. Elegant design enables the efficient distribution of the light to the targeted area.

BALLAST

Electronic ballast with long life, low power loss EEI = A2 and constant flux. Compatible with ENEC standards.

CORPS

Corps en aluminium anodisé, satiné. Design Élégant. Couleurs argent et bronze disponibles. Epaisseur : 37 mm.

REFLECTEUR

En aluminium anodisé à 99,9% de pureté et avec une surface brillante comme un miroir assurant un niveau élevé de réflexion. Design Élégant. Permet une répartition efficace de la lumière vers l'endroit ciblé.

BALLAST

Ballast électronique, conforme aux normes ENEC. Longue vie. Perte de puissance faible (EEI=A2). Flux de lumière régulier.

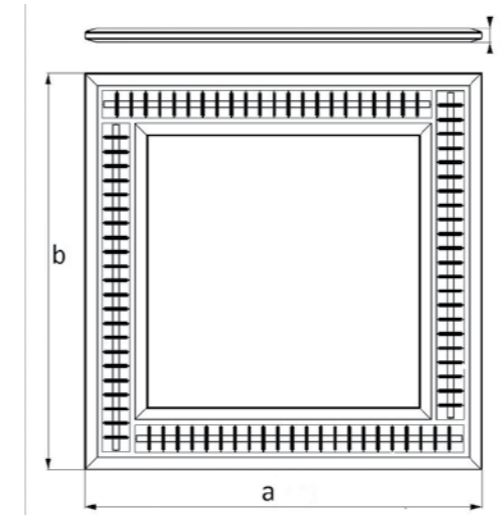

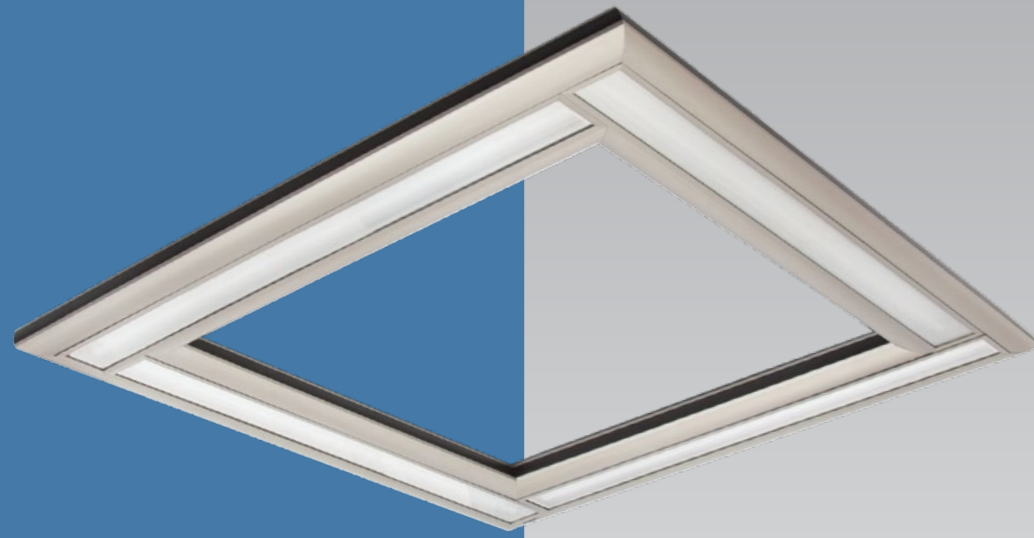

ELEGANT

Renk Seçenekleri
Color Options
Options de Couleur

Gümüş
Silver
Argent

Bronz
Bronze



LED / T16 (T5)

Kare Sıva Üstü Prizmatik Difüzörlü
Aydınlatma Armatürleri

Surface Mounted Square Lighting
Fixtures With Prismatic Diffuser

Luminaire Carrés Apparents Avec
Diffuseur Prismatique

UYGULAMA ALANLARI

Ofisler
Toplantı Odaları
Mağazalar
Hastaneler
Okullar
Koridorlar

APPLICATION AREAS

Offices
Meeting rooms
Stores
Hospitals
Schools
Corridors

DOMAINES D'UTILISATION

Bureaux
Salles de Réunion
Magasins
Hopitaux
Ecoles
Coulors

GÖVDE

Bronz ve Gümüş renk seçeneği, ince (37mm) zarif tasarıma sahip, saten eloksal kaplamalı alüminyum.

DİFÜZÖR

UV korumalı akrilik prizmatik difüzör.

BALAST (T5 Modeller İçin)

ENEC standartlarına uygun, uzun ömürlü sabit ışık akısına sahip, düşük enerji kayıplı (EEI=A2) elektronik balast.

KONVERTÖR (LED'li Modeller İçin)

ENEC standartlarına uygun, uzun ömürlü sabit akımlı konvertör.

LED (LED'li Modeller İçin)

50.000 saat ömürlü LUMILEDS / OSRAM / SEOUL marka LED'li LED modüller.

BODY

Anodized aluminum with satin finishing. Bronze and silver color options with thin (37mm) elegant design.

DIFFUSER

UV stabilized acrylic prismatic diffuser.

BALLAST (For T5 Models)

Electronic ballast with long life, low power loss EEI = A2 and constant flux. Compatible with ENEC standards.

CONVERTER (For LED Models)

Long life, low power loss converter with constant current. Compatible with ENEC standards.

LED (For LED Models)

LED modules with 50,000 hours lifetime LUMILEDS / OSRAM / SEOUL brand LEDs.

CORPS

Corps en aluminium anodisé, satiné. Design Élégant. Couleurs argent et bronze disponibles. Epaisseur : 37mm.

DIFFUSEUR

Diffuseur prismatique en acrylique. Anti UV.

BALLAST (Pour T5 Modèles)

Ballast électronique, conforme aux normes ENEC. Longue vie. Perte de puissance faible (EEI = A2). Flux de lumière régulier.

CONVERTEUR (Pour Modèles LED)

Convertisseur, conforme aux normes ENEC. Longue vie. Perte de puissance faible avec courant constant.

LED (Pour Modèles LED)

Modules LED - Durée de vie 50.000 heures avec LED de marque LUMILEDS / OSRAM / SEOUL.

LED'li Tip / LED Type / Type LED

Renk Geri Verim Indexi / Color Rendering Index / Indice de Rendu des Couleurs: (CRI): Ra>80

Kod Code	Güç Power Puissance (W)	LED Tipi LED Type Type De LED	LED Modül LED Module Module LED	Işık Akısı Lum. Flux Flux Lum. (lm)	Renk Sıcaklığı Color Temperature Température De Couleur (K)	Ölçüler Dimensions (mm)			Ağırlık Weight Poids (kg)	Ambalaj Adedi Packing Quantity Colisage	Adet/20" Konteyner Pcs./20" Container Pcs./20" Conteneur
						a	b	h			
PL1UK22L15C	8x6,5	3535 SMD	PCB	6800	3000 / 4000 / 6500	806	806	37	6.1	1	850
PL1UK33L15C	12x6,5	3535 SMD	PCB	10200	3000 / 4000 / 6500	1086	1086	37	9.5	1	480
PL1UK44L15C	16x6,5	3535 SMD	PCB	13600	3000 / 4000 / 6500	1366	1366	37	13.1	1	300
PL1UK23L15C	10x6,5	3535 SMD	PCB	8500	3000 / 4000 / 6500	806	1086	37	8.1	1	630
PL1UK24L15C	12x6,5	3535 SMD	PCB	10200	3000 / 4000 / 6500	806	1366	37	9.9	1	510
PL1UK34L15C	14x6,5	3535 SMD	PCB	11900	3000 / 4000 / 6500	1086	1366	37	11.3	1	380

T5 Floresanlı Tip / T5 Fluorescent Type / Type T5 Fluorescent

Kod Code	Güç Power Puissance (W)	Ampul Tipi Lamp Type Type De Lampe	Duy Tipi Socket Type Type De Douille	Işık Akısı Lum. Flux Flux Lum. (lm)	Akım Current Courant (A)	Ölçüler Dimensions (mm)			Ağırlık Weight Poids (kg)	Ambalaj Adedi Packing Quantity Colisage	Adet/20" Konteyner Pcs./20" Container Pcs./20" Conteneur
						a	b	h			
P51UK414C	4x14	T16(T5)	G5	4800	0.28	730	730	37	5.0	1	1040
P51UK421C	4x21	T16(T5)	G5	7600	0.40	1030	1030	37	8.6	1	530
P51UK428C	4x28	T16(T5)	G5	10400	0.52	1330	1330	37	12.3	1	320
P51UK214221C	2x14 + 2x21	T16(T5)	G5	6200	0.34	730	1030	37	6.9	1	740
P51UK214228C	2x14 + 2x28	T16(T5)	G5	7600	0.40	730	1330	37	8.7	1	580
P51UK221228C	2x21 + 2x28	T16(T5)	G5	9000	0.46	1030	1330	37	10.5	1	410

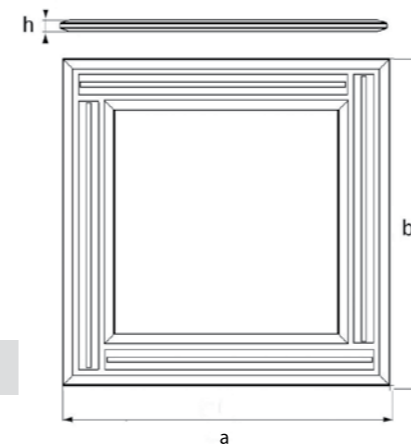

V / Hz 220 - 240 / 50 - 60

Opsiyonlar	Options	Options
DIM edilebilir elektronik balast yada konvertör. LED'li modeller için acil durum kiti.	Dimmable electronic ballast or convertor. Emergency kit for models with LED	Ballast électronique dimmable ou converteur. Kit d'urgence pour les modèles LED.



ELEGANT



Direkt - Endirekt Aydınlatma
Direct - Indirect Lighting
Eclairage Direct - Indirect

Renk Seçenekleri
Color Options
Options de Couleur

Gümüş
Silver
Argent

Bronz
Bronze



T16 (T5)

Sarkıt 1X Alüminyum Reflektörlü
Aydınlatma Armatürleri

Suspended 1X Lighting Fixtures
With Aluminum Reflector

Luminaire Suspendus 1X Avec
Reflecteur en Aluminium

UYGULAMA ALANLARI

Ofisler
Toplantı Odaları
Mağazalar
Hastaneler
Okullar
Koridorlar

APPLICATION AREAS

Offices
Meeting rooms
Stores
Hospitals
Schools
Corridors

DOMAINES D'UTILISATION

Bureaux
Salles de Réunion
Magasins
Hopitaux
Ecoles
Couloirs

GÖVDE

Bronz ve Gümüş renk seçeneği, ince (37mm) zarif tasarıma sahip, saten eloksallı alüminyum.

REFLEKTÖR

%99 Safılıkta, ayna yüzeyi parlaklığında ve yüksek yansıtma performansına sahip ışığın verimli bir şekilde dağılımını sağlayan zarif tasarımlı eloksallı alüminyum.

ARKA YÜZ DİFÜZÖRLER

UV korumalı akrilik prizmatik difüzör.

BALAST

ENEC standartlarına uygun, uzun ömürlü sabit ışık akısına sahip, düşük enerji kayıplı (EEI=A2) elektronik balast

ASKI

1mm çelik örgü tel ve nikel kaplamalı prınç parçalardan mamul, askı boyu ayarlanabilir, şeffaf elektrik kablosu ve tavana monte edilen estetik tasarıma sahip elektrik bağlantı kutusu ile birlikte.

BODY

Anodized aluminum with satin finishing. Bronze and silver color options with thin (37mm) elegant design.

REFLECTOR

Anodized aluminum with %99,9 purity and with mirror like glossy surface having high reflection performance. Elegant design enables the efficient distribution of the light to the targeted area.

BACK SIDE DIFFUSERS

UV stabilized acrylic prismatic diffuser.

BALLAST

Electronic ballast with long life, low power loss EEI = A2 and constant flux. Compatible with ENEC standards.

SUSPENSION

Composed of 1mm steel wire rope and nickel-plated brass components. Suspension height is adjustable. Supplied with transparent electric cord and ceiling mounted electrical junction box with aesthetic design.

CORPS

En aluminium anodisé, satiné. Design élégant. Couleurs argent et bronze disponibles. Epaisseur : 37mm.

REFLECTEUR

En aluminium anodisé a 99,99% de pureté et avec une surface brillante comme un miroir, assurant un niveau élevé de réflexion. Design élégant. Permet une répartition efficace de la lumière vers l'endroit ciblé.

DIFFUSEURS DE LA FACE ARRIERE

Diffuseur prismatique en acrylique. Anti UV.

BALLAST

Ballast électronique, conforme aux normes ENEC. Longue vie. Perte de puissance faible (EEI=A2). Flux de lumière régulier.

SYSTEME DE FIXATION

Composé d'un câble en acier de 1 mm, de composants en laiton nickelés. Livré avec un cordon électrique transparent et une boîte de jonction électrique à fixer au plafond.

T5 Floresanlı Tip / T5 Fluorescent Type / Type T5 Fluorescent

Kod Code	Güç Power Puissance (W)	Ampul Tipi Lamp Type Typ. De Lamp.	Duy Tipi Socket Type Type De Douille	Işık Akısı Lum. Flux Flux Lum. (lm)	Akım Current Courant (A)	Ölçüler Dimensions (mm)			Ağırlık Weight Poids (kg)	Ambalaj Adedi Packing Quantity Colisage	Adet/20" Konteyner Pcs./20" Container Pcs./20" Conteneur
						a	b	h			
P51S114A	1x14	T16(T5)	G5	1200	0.08	165	650	37	1.5	2	4300
P51S124A	1x24	T16(T5)	G5	1750	0.12	165	650	37	1.5	2	4300
P51S121A	1x21	T16(T5)	G5	1900	0.11	165	950	37	2.1	2	3000
P51S128A	1x28	T16(T5)	G5	2600	0.14	165	1250	37	2.7	2	2280
P51S154A	1x54	T16(T5)	G5	4450	0.26	165	1250	37	2.7	2	2280
P51S135A	1x35	T16(T5)	G5	3300	0.17	165	1550	37	3.3	2	1860
P51S149A	1x49	T16(T5)	G5	4300	0.24	165	1550	37	3.3	2	1860
P51S180A	1x80	T16(T5)	G5	6150	0.38	165	1550	37	3.3	2	1860

V / Hz 220 - 240 / 50 - 60

Opsiyonlar	Options	Options
DİM edilebilir elektronik balast.	Dimmable electronic ballast.	Ballast électronique dimmable.



ELEGANT

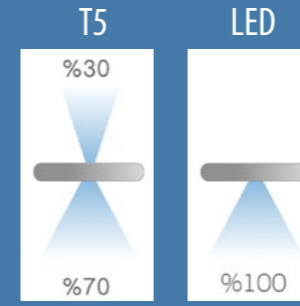

Renk Seçenekleri
Color Options
Options de Couleur

Gümüş
Silver
Argent

Bronz
Bronze

LED / T16 (T5)

Sarkıt 1X Prizmatik Difüzörlü
Aydınlatma Armatürleri

Suspended 1X Lighting Fixtures
With Prismatic Diffuser

Luminaire Suspendus 1X Avec
Diffuseur Prismatique

UYGULAMA ALANLARI

Ofisler
Toplantı Odaları
Mağazalar
Hastaneler
Okullar
Koridorlar

APPLICATION AREAS

Offices
Meeting rooms
Stores
Hospitals
Schools
Corridors

DOMAINES D'UTILISATION

Bureaux
Salles de Réunion
Magasins
Hopitaux
Ecoles
Coulors

GÖVDE

Bronz ve gümüş renk seçeneği, ince (37mm) zarif tasarıma sahip, saten eloksallı kaplamalı alüminyum.

ÖN VE ARKA YÜZ DİFÜZÖRLER

UV korumalı akrilik prizmatik difüzör.

BALAST (T5 Modeller İçin)

ENEC standartlarına uygun, uzun ömürlü sabit ışık akısına sahip, düşük enerji kayıplı (EEI=A2) elektronik balast.

KONVERTÖR (LED'li Modeller İçin)

ENEC standartlarına uygun, uzun ömürlü sabit akımlı konvertör.

LED (LED'li Modeller İçin)

50.000 saat ömürlü LUMILEDS / OSRAM / SEOUL marka LED'li LED modülleri.

ASKI

1mm çelik örgü tel ve nikel kaplamalı princi parçalardan mamul, askı boyu ayarlanabilir, şeffaf elektrik kablosu ve tavana monte edilen estetik tasarıma sahip elektrik bağlantı kutusu ile birlikte.

BODY

Anodized aluminum with satin finishing. Bronze and silver color options with thin (37mm) elegant design.

BACK AND FRONT SIDE DIFFUSERS

UV stabilized acrylic prismatic diffuser.

BALLAST (For T5 Models)

Electronic ballast with long life, low power loss EEI = A2 and constant flux. Compatible with ENEC standards.

CONVERTER (For LED Models)

Long life, low power loss converter with constant current. Compatible with ENEC standards.

LED (For LED Models)

LED modules with 50,000 hours lifetime LUMILEDS / OSRAM / SEOUL brand LEDs.

SUSPENSION

Composed of 1mm steel wire rope and nickel-plated brass components. Suspension height is adjustable. Supplied with transparent electric cord and ceiling mounted electrical junction box with aesthetic design.

CORPS

Corps en aluminium anodisé, satiné. Design Élégant. Couleurs argent et bronze disponibles. Epaisseur : 37mm.

DIFFUSEURS AVANT ET ARRIERE

Diffuseur prismatique en acrylique. Anti UV.

BALLAST (Pour T5 Modèles)

Ballast électronique, conforme aux normes ENEC. Longue vie. Perte de puissance faible (EEI = A2). Flux de lumière régulier.

CONVERTEUR (Pour Modèles LED)

Convertisseur, conforme aux normes ENEC. Longue vie. Perte de puissance faible avec courant constant.

LED (Pour Modèles LED)

Modules LED - Durée de vie 50.000 heures avec LED de marque LUMILEDS / OSRAM / SEOUL.

SYSTEME DE FIXATION

Composé d'un câble en acier de 1 mm, de composants en laiton nickelés. Livré avec un cordon électrique transparent et une boîte de jonction électrique à fixer au plafond.

LED'li Tip / LED Type / Type LED

Renk Geri Verim Indexi / Color Rendering Index / Indice de Rendu des Couleurs: (CRI): Ra>80

Kod Code	Güç Power Puissance (W)	LED Tipi LED Type Type De LED	LED Modül LED Module Module LED	Işık Akısı Lum. Flux Flux Lum. (lm)	Renk Sıcaklığı Color Temperature Température De Couleur (K)	Ölçüler Dimensions (mm)			Ağırlık Weight Poids (kg)	Ambalaj Adedi Packing Quantity Colisage	Adet/20" Konteyner Pcs./20" Container Pcs./20" Conteneur
						a	b	h			
PL1S11L15C	1x6,5	3535 SMD	PCB	850	3000 / 4000 / 6500	165	438	37	1.2	2	6500
PL1S12L15C	2x6,5	3535 SMD	PCB	1700	3000 / 4000 / 6500	165	718	37	1.9	2	3950
PL1S13L15C	3x6,5	3535 SMD	PCB	2550	3000 / 4000 / 6500	165	998	37	2.6	2	2850
PL1S14L15C	4x6,5	3535 SMD	PCB	3400	3000 / 4000 / 6500	165	1278	37	3.4	2	2230
PL1S15L15C	5x6,5	3535 SMD	PCB	4250	3000 / 4000 / 6500	165	1558	37	4.1	2	1850

T5 Floresanlı Tip / T5 Fluorescent Type / Type T5 Fluorescent

Kod Code	Güç Power Puissance (W)	Ampul Tipi Lamp Type Type De Lampe	Duy Tipi Socket Type Type De Douille	Işık Akısı Lum. Flux Flux Lum. (lm)	Akım Current Courant (A)	Ölçüler Dimensions (mm)			Ağırlık Weight Poids (kg)	Ambalaj Adedi Packing Quantity Colisage	Adet/20" Konteyner Pcs./20" Container Pcs./20" Conteneur
						a	b	h			
P51S114C	1x14	T16(T5)	G5	1200	0.08	165	650	37	1.7	2	4300
P51S124C	1x24	T16(T5)	G5	1750	0.12	165	650	37	1.7	2	4300
P51S121C	1x21	T16(T5)	G5	1900	0.11	165	950	37	2.5	2	3000
P51S128C	1x28	T16(T5)	G5	2600	0.14	165	1250	37	3.3	2	2280
P51S154C	1x54	T16(T5)	G5	4450	0.26	165	1250	37	3.3	2	2280
P51S135C	1x35	T16(T5)	G5	3300	0.17	165	1550	37	4.1	2	1860
P51S149C	1x49	T16(T5)	G5	4300	0.24	165	1550	37	4.1	2	1860
P51S180C	1x80	T16(T5)	G5	6150	0.38	165	1550	37	4.1	2	1860

Opsiyonlar	Options	Options
DIM edilebilir elektronik balast yada konvertör.	Dimmable electronic ballast or convertor.	Ballast Dimmable ou converteur.
LED'li modeller için acil durum kiti.	Emergency kit for models with LED	Kit d'urgence pour les modèles LED.

V / Hz 220 - 240 / 50 - 60



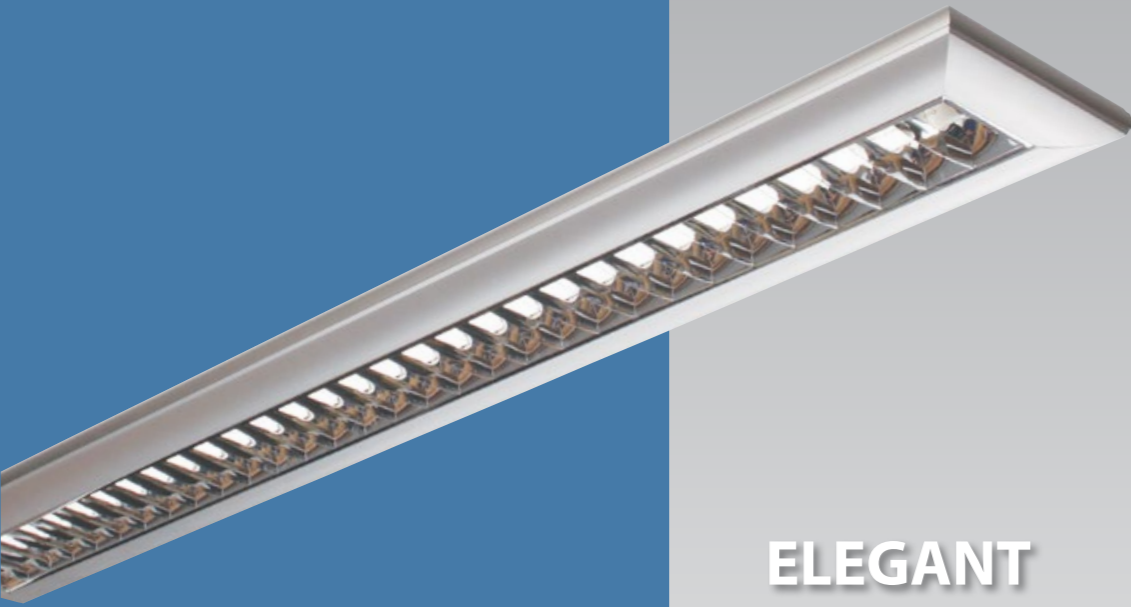

ELEGANT

Renk Seçenekleri
Color Options
Options de Couleur

Gümüş
Silver
Argent

Bronz
Bronze



T16 (T5)

Sıva Üstü 1X Alüminyum Reflektörlü Aydınlatma Armatürleri

Surface Mounted 1X Lighting Fixtures With Aluminum Reflector

Luminaire Apparents 1X Avec Reflecteur en Aluminium

UYGULAMA ALANLARI

Ofisler
Toplantı Odaları
Mağazalar
Hastaneler
Okullar
Koridorlar

APPLICATION AREAS

Offices
Meeting rooms
Stores
Hospitals
Schools
Corridors

DOMAINES D'UTILISATION

Bureaux
Salles de Réunion
Magasins
Hopitaux
Ecoles
Couloirs

Kod Code	Güç Power Puissance (W)	Ampul Tipi Lamp Type Typ. De Lamp.	Duy Tipi Socket Type Type De Douille	Işık Akısı Lum. Flux Flux Lum. (lm)	Akım Current Courant (A)	Ölçüler Dimensions (mm)			Ağırlık Weight Poids (kg)	Ambalaj Adedi Packing Quantity Colisage	Adet/20" Konteyner Pcs./20" Container Pcs./20" Conteneur
						a	b	h			
P51U114A	1x14	T16(T5)	G5	1200	0.08	165	650	37	1.0	2	4600
P51U124A	1x24	T16(T5)	G5	1750	0.12	165	650	37	1.0	2	4600
P51U121A	1x21	T16(T5)	G5	1900	0.11	165	950	37	1.8	2	3200
P51U128A	1x28	T16(T5)	G5	2600	0.14	165	1250	37	2.6	2	2370
P51U154A	1x54	T16(T5)	G5	4450	0.26	165	1250	37	2.6	2	2370
P51U135A	1x35	T16(T5)	G5	3300	0.17	165	1550	37	3.4	2	1920
P51U149A	1x49	T16(T5)	G5	4300	0.24	165	1550	37	3.4	2	1920
P51U180A	1x80	T16(T5)	G5	6150	0.38	165	1550	37	3.4	2	1920

GÖVDE

Bronz ve Gümüş renk seçeneği, ince (37mm) zarif tasarıma sahip, saten eloksallı alüminyum.

REFLEKTÖR

%99,9 Safılıkta, ayna yüzeyi parlaklığında ve yüksek yansıtma performansına sahip ışığın verimli bir şekilde dağılımını sağlayan zarif tasarımlı eloksallı alüminyum.

BALAST

ENEC standartlarına uygun, uzun ömürlü sabit ışık akısına sahip, düşük enerji kayıplı (EEI=A2) elektronik balast

BODY

Anodized aluminum with satin finishing. Bronze and silver color options with thin (37mm) elegant design.

REFLECTOR

Anodized aluminum with %99,9 purity and with mirror like glossy surface having high reflection performance. Elegant design enables the efficient distribution of the light to the targeted area.

BALLAST

Electronic ballast with long life, low power loss EEI = A2 and constant flux. Compatible with ENEC standards.

CORPS

Corps en aluminium anodisé, satiné. Design Élégant. Couleurs argent et bronze disponibles. Epaisseur : 37 mm.

REFLECTEUR

En aluminium anodisé a 99,9% de pureté et avec une surface brillante comme un miroir assurant un niveau élevé de réflexion. Design Élégant. Permet une répartition efficace de la lumière vers l'endroit ciblé.

BALLAST

Ballast électronique, conforme aux normes ENEC. Longue vie. Perte de puissance faible (EEI=A2). Flux de lumière régulier.

C0 - C180
P51U135A C90 - C270

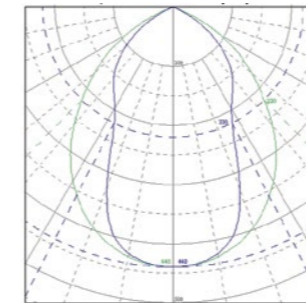

V / Hz 220 - 240 / 50 - 60

Opsiyonlar	Options	Options
DIM edilebilir elektronik balast.	Dimmable electronic ballast.	Ballast électronique dimmable.



ELEGANT

Renk Seçenekleri
Color Options
Options de Couleur

Gümüş
Silver
Argent

Bronz
Bronze

LED / T16 (T5)

Sıva Üstü 1X Prizmatik
Difüzörlü Aydınlatma Armatürleri

Surface Mounted 1X Lighting
Fixtures With Prismatic Diffuser

Luminaire Apparents 1X Avec
Diffuseur Prismatique

UYGULAMA ALANLARI

Ofisler
Toplantı Odaları
Mağazalar
Hastaneler
Okullar
Koridorlar

APPLICATION AREAS

Offices
Meeting rooms
Stores
Hospitals
Schools
Corridors

DOMAINES D'UTILISATION

Bureaux
Salles de Réunion
Magasins
Hopitaux
Ecoles
Coulors

GÖVDE

Bronz ve gümüş renk seçeneği, ince (37mm) zarif tasarıma sahip, saten eloksallı kaplamalı alüminyum.

DİFÜZÖR

UV korumalı akrilik prizmatik difüzör.

BALAST (T5 Modeller İçin)

ENEC standartlarına uygun, uzun ömürlü sabit ışık akısına sahip, düşük enerji kayıplı (EEI=A2) elektronik balast.

KONVERTÖR (LED'li Modeller İçin)

ENEC standartlarına uygun, uzun ömürlü sabit akımlı konvertör.

LED (LED'li Modeller İçin)

50.000 saat ömürlü LUMILEDS / OSRAM / SEOUL marka LED'li LED modülleri.

BODY

Anodized aluminum with satin finishing. Bronze and silver color options with thin (37mm) elegant design.

DIFFUSER

UV stabilized acrylic prismatic diffuser.

BALLAST (For T5 Models)

Electronic ballast with long life, low power loss EEI = A2 and constant flux. Compatible with ENEC standards.

CONVERTER (For LED Models)

Long life, low power loss converter with constant current. Compatible with ENEC standards.

LED (For LED Models)

LED modules with 50,000 hours lifetime LUMILEDS / OSRAM / SEOUL brand LEDs.

CORPS

Corps en aluminium anodisé, satiné. Design Élégant. Couleurs argent et bronze disponibles. Epaisseur : 37mm.

DIFFUSEUR

Diffuseur prismatique en acrylique. Anti UV.

BALLAST (Pour T5 Modèles)

Ballast électronique, conforme aux normes ENEC. Longue vie. Perte de puissance faible (EEI = A2). Flux de lumière régulier.

CONVERTEUR (Pour Modèles LED)

Convertisseur, conforme aux normes ENEC. Longue vie. Perte de puissance faible avec courant constant.

LED (Pour Modèles LED)

Modules LED - Durée de vie 50.000 heures avec LED de marque LUMILEDS / OSRAM / SEOUL.

LED'li Tip / LED Type / Type LED

Renk Geri Verim Indexi / Color Rendering Index / Indice de Rendu des Couleurs: (CRI): Ra>80

Kod Code	Güç Power Puissance (W)	LED Tipi LED Type Type De LED	LED Modül LED Module Module LED	Işık Akısı Lum. Flux Flux Lum. (lm)	Renk Sıcaklığı Color Temperature Température De Couleur (K)	Ölçüler Dimensions (mm)			Ağırlık Weight Poids (kg)	Ambalaj Adedi Packing Quantity Colisage	Adet/20" Konteyner Pcs./20" Container Pcs./20" Conteneur
						a	b	h			
PL1U11L15C	1x6,5	3535 SMD	PCB	850	3000 / 4000 / 6500	165	438	37	1.3	2	6700
PL1U12L15C	2x6,5	3535 SMD	PCB	1700	3000 / 4000 / 6500	165	718	37	2.0	2	4100
PL1U13L15C	3x6,5	3535 SMD	PCB	2550	3000 / 4000 / 6500	165	998	37	2.7	2	2950
PL1U14L15C	4x6,5	3535 SMD	PCB	3400	3000 / 4000 / 6500	165	1278	37	3.5	2	2300
PL1U15L15C	5x6,5	3535 SMD	PCB	4250	3000 / 4000 / 6500	165	1558	37	4.2	2	1900

T5 Floresanlı Tip / T5 Fluorescent Type / Type T5 Fluorescent

Kod Code	Güç Power Puissance (W)	Ampul Tipi Lamp Type Typ. De Lamp.	Duy Tipi Socket Type Type De Douille	Işık Akısı Lum. Flux Flux Lum. (lm)	Akım Current Courant (A)	Ölçüler Dimensions (mm)			Ağırlık Weight Poids (kg)	Ambalaj Adedi Packing Quantity Colisage	Adet/20" Konteyner Pcs./20" Container Pcs./20" Conteneur
						a	b	h			
P51U114C	1x14	T16(T5)	G5	1200	0.08	165	650	37	1.7	2	4600
P51U124C	1x24	T16(T5)	G5	1750	0.12	165	650	37	1.7	2	4600
P51U121C	1x21	T16(T5)	G5	1900	0.11	165	950	37	2.5	2	3200
P51U128C	1x28	T16(T5)	G5	2600	0.14	165	1250	37	3.3	2	2370
P51U154C	1x54	T16(T5)	G5	4450	0.26	165	1250	37	3.3	2	2370
P51U135C	1x35	T16(T5)	G5	3300	0.17	165	1550	37	4.1	2	1920
P51U149C	1x49	T16(T5)	G5	4300	0.24	165	1550	37	4.1	2	1920
P51U180C	1x80	T16(T5)	G5	6150	0.38	165	1550	37	4.1	2	1920

P51U135C C0 - C180
C90 - C270

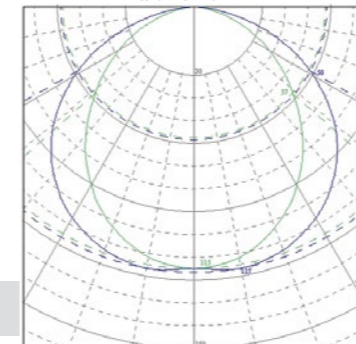

V / Hz 220 - 240 / 50 - 60

Opsiyonlar	Options	Options
DIM edilebilir elektronik balast yada konvertör. LED'li modeller için acil durum kit.	Dimmable electronic ballast or convertor. Emergency kit for models with LED	Ballast électronique dimmable ou converteur. Kit d'urgence pour les modèles LED.





ELEGANT



Direkt - Endirekt Aydınlatma
Direct - Indirect Lighting
Eclairage Direct - Indirect

Renk Seçenekleri
Color Options
Options de Couleur

Gümüş
Silver
Argent

Bronz
Bronze



T16 (T5)

Sarkıt 2X Alüminyum Reflektörlü Aydınlatma Armatürleri

Suspended 2X Lighting Fixtures With Aluminum Reflector

Luminaire Suspendus 2X Avec Reflecteur en Aluminium

UYGULAMA ALANLARI

Ofisler
Toplantı Odaları
Mağazalar
Hastaneler
Okullar
Koridorlar

APPLICATION AREAS

Offices
Meeting rooms
Stores
Hospitals
Schools
Corridors

DOMAINES D'UTILISATION

Bureaux
Salles de Réunion
Magasins
Hopitaux
Ecoles
Couloirs

GÖVDE

Bronz ve Gümüş renk seçeneği, ince (37mm) zarif tasarıma sahip, saten eloksallı kaplamalı alüminyum.

REFLEKTÖR

%99 Saflıkta, ayna yüzeyi parlaklığında ve yüksek yansıtma performansına sahip ışığın verimli bir şekilde dağılımını sağlayan zarif tasarımı eloksallı kaplamalı alüminyum.

ARKA YÜZ DİFÜZÖRLER

UV korumalı akrilik prizmatik difüzör.

BALAST

ENEC standartlarına uygun, uzun ömürlü sabit ışık akısına sahip, düşük enerji kayıplı (EEI=A2) elektronik balast

ASKI

1mm çelik örgü tel ve nikel kaplamalı princi parçalardan mamul, askı boyu ayarlanabilir, şeffaf elektrik kablosu ve tavana monte edilen estetik tasarıma sahip elektrik bağlantı kutusu ile birlikte.

BODY

Anodized aluminum with satin finishing. Bronze and silver color options with thin (37mm) elegant design.

REFLECTOR

Anodized aluminum with %99,9 purity and with mirror like glossy surface having high reflection performance. Elegant design enables the efficient distribution of the light to the targeted area.

BACK SIDE DIFFUSERS

UV stabilized acrylic prismatic diffuser.

BALLAST

Electronic ballast with long life, low power loss EEI = A2 and constant flux. Compatible with ENEC standards.

SUSPENSION

Composed of 1mm steel wire rope and nickel-plated brass components. Suspension height is adjustable. Supplied with transparent electric cord and ceiling mounted electrical junction box with aesthetic design.

CORPS

En aluminium anodisé, satiné. Design élégant. Couleurs argent et bronze disponibles. Epaisseur : 37mm.

REFLECTEUR

En aluminium anodisé a 99,99% de pureté et avec une surface brillante comme un miroir, assurant un niveau élevé de réflexion. Design élégant. Permet une répartition efficace de la lumière vers l'endroit ciblé.

DIFFUSEURS DE LA FACE ARRIERE

Diffuseur prismatique en acrylique. Anti UV.

BALLAST

Ballast électronique, conforme aux normes ENEC. Longue vie. Perte de puissance faible (EEI=A2). Flux de lumière régulier.

SYSTEME DE FIXATION

Composé d'un câble en acier de 1 mm, de composants en laiton nickelés. Livré avec un cordon électrique transparent et une boîte de jonction électrique à fixer au plafond.

Kod Code	Güç Power Puissance (W)	Ampul Tipi Lamp Type Typ. De Lamp.	Duy Tipi Socket Type Type De Douille	Işık Akısı Lum. Flux Flux Lum. (lm)	Akım Current Courant (A)	Ölçüler Dimensions (mm)			Ağırlık Weight Poids (kg)	Ambalaj Adedi Packing Quantity Colisage	Adet/20" Konteyner Pcs./20" Container Pcs./20" Conteneur
						a	b	h			
P51S214A	2x14	T16(T5)	G5	2400	0.14	287	650	37	2.55	4	2320
P51S224A	2x24	T16(T5)	G5	3500	0.23	287	650	37	2.55	4	2320
P51S221A	2x21	T16(T5)	G5	3800	0.20	287	950	37	3.37	2	1620
P51S228A	2x28	T16(T5)	G5	5200	0.26	287	1250	37	4.26	2	1210
P51S254A	2x54	T16(T5)	G5	8900	0.50	287	1250	37	4.26	2	1210
P51S235A	2x35	T16(T5)	G5	6600	0.33	287	1550	37	5.20	2	1000
P51S249A	2x49	T16(T5)	G5	8600	0.49	287	1550	37	5.20	2	1000
P51S280A	2x80	T16(T5)	G5	12300	0.76	287	1550	37	5.20	2	1000

V / Hz	220 - 240 / 50 - 60
--------	---------------------

Opsiyonlar	Options	Options
DIM edilebilir elektronik balast. Acil durum kiti.	Dimmable electronic ballast. Emergency kit	Ballast électronique dimmable. Kit d'urgence.

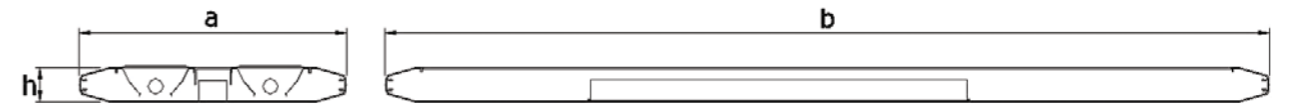



ELEGANT

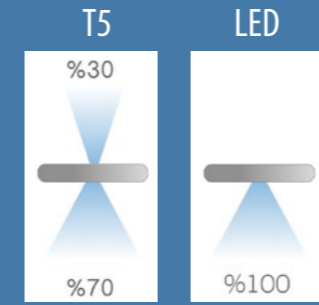

Renk Seçenekleri
Color Options
Options de Couleur

Gümüş
Silver
Argent

Bronz
Bronze



LED / T16 (T5)

Sarkıt 2X Prizmatik Difüzörlü
Aydınlatma Armatürleri

Suspended 2X Lighting Fixtures
With Prismatic Diffuser

Luminaire Suspendus 2X Avec
Diffuseur Prismatique

UYGULAMA ALANLARI

Ofisler
Toplantı Odaları
Mağazalar
Hastaneler
Okullar
Koridorlar

APPLICATION AREAS

Offices
Meeting rooms
Stores
Hospitals
Schools
Corridors

DOMAINES D'UTILISATION

Bureaux
Salles de Réunion
Magasins
Hopitaux
Ecoles
Coulloirs

GÖVDE

Bronz ve Gümüş renk seçeneği, ince (37mm) zarif tasarıma sahip, saten eloksallı kaplamalı alüminyum.

ÖN VE ARKA YÜZ DİFÜZÖRLER

UV korumalı akrilik prizmatik difüzör.

BALAST (T5 Modeller İçin)

ENEC standartlarına uygun, uzun ömürlü sabit ışık akısına sahip, düşük enerji kayıplı (EEI=A2) elektronik balast

KONVERTÖR (LED'li Modeller İçin)

ENEC standartlarına uygun, uzun ömürlü sabit akımlı konvertör.

LED (LED'li Modeller İçin)

50.000 saat ömürlü LUMILEDS / OSRAM / SEOUL marka LED'li LED modülleri.

ASKI

1mm çelik örgü tel ve nikel kaplamalı princi parçalardan mamul, askı boyu ayarlanabilir, şeffaf elektrik kablosu ve tavana monte edilen estetik tasarıma sahip elektrik bağlantı kutusu ile birlikte.

BODY

Anodized aluminum with satin finishing. Bronze and silver color options with thin (37mm) elegant design.

BACK AND FRONT SIDE DIFFUSERS

UV stabilized acrylic prismatic diffuser.

BALLAST (For T5 Models)

Electronic ballast with long life, low power loss EEI = A2 and constant flux. Compatible with ENEC standards.

CONVERTER (For LED Models)

Long life, low power loss converter with constant current. Compatible with ENEC standards.

LED (For LED Models)

LED modules with 50,000 hours lifetime LUMILEDS / OSRAM / SEOUL brand LEDs.

SUSPENSION

Composed of 1mm steel wire rope and nickel-plated brass components. Suspension height is adjustable. Supplied with transparent electric cord and ceiling mounted electrical junction box with aesthetic design.

CORPS

Corps en aluminium anodisé, satiné. Design élégant. Couleurs argent et bronze disponibles. Epaisseur 37 mm.

DIFFUSEURS AVANT ET ARRIERE

Diffuseur prismatique en acrylique. Anti UV.

BALLAST (Pour T5 Modèles)

Ballast électronique, conforme aux normes ENEC. Longue vie. Perte de puissance faible (EEI=A2). Flux de lumière régulier.

CONVERTEUR (Pour Modèles LED)

Convertisseur, conforme aux normes ENEC. Longue vie. Perte de puissance faible avec courant constant.

LED (Pour Modèles LED)

Modules LED - Durée de vie 50.000 heures avec LED de marque LUMILEDS / OSRAM / SEOUL.

SYSTEME DE FIXATION

Composé d'un fil en acier de 1mm, de composants en laiton nickelés. Livré avec un cordon électrique transparent et une boîte de jonction électrique à fixer au plafond.

LED'li Tip / LED Type / Type LED Renk Geri Verim Indexi / Color Rendering Index / Indice de Rendu des Couleurs: (CRI): Ra>80

Kod Code	Güç Power Puissance (W)	LED Tipi LED Type Type De LED	LED Modül LED Module Module LED	Işık Akısı Lum. Flux Flux Lum. (lm)	Renk Sıcaklığı Color Temperature Température De Couleur (K)	Ölçüler Dimensions (mm)			Ağırlık Weight Poids (kg)	Ambalaj Adedi Packing Quantity Colisage	Adet/20" Konteyner Pcs./20" Conteneur
						a	b	h			
PL1S21L15C	2x6,5	3535 SMD	PCB	1700	3000 / 4000 / 6500	287	438	37	2.2	4	3500
PL1S22L15C	4x6,5	3535 SMD	PCB	3400	3000 / 4000 / 6500	287	718	37	3.3	4	2140
PL1S23L15C	6x6,5	3535 SMD	PCB	5100	3000 / 4000 / 6500	287	998	37	4.3	2	1540
PL1S24L15C	8x6,5	3535 SMD	PCB	6800	3000 / 4000 / 6500	287	1278	37	5.4	2	1180
PL1S25L15C	10x6,5	3535 SMD	PCB	8500	3000 / 4000 / 6500	287	1558	37	6.7	2	990

T5 Floresanlı Tip / T5 Fluorescent Type / Type T5 Fluorescent

Kod Code	Güç Power Puissance (W)	Ampul Tipi Lamp Type Typ. De Lamp.	Duy Tipi Socket Type Type De Douille	Işık Akısı Lum. Flux Flux Lum. (lm)	Akım Current Courant (A)	Ölçüler Dimensions (mm)			Ağırlık Weight Poids (kg)	Ambalaj Adedi Packing Quantity Colisage	Adet/20" Konteyner Pcs./20" Conteneur
						a	b	h			
P51S214C	2x14	T16(T5)	G5	2400	0.14	287	650	37	3.0	4	2320
P51S224C	2x24	T16(T5)	G5	3500	0.23	287	650	37	3.0	4	2320
P51S221C	2x21	T16(T5)	G5	3800	0.20	287	950	37	4.3	2	1620
P51S228C	2x28	T16(T5)	G5	5200	0.26	287	1250	37	5.3	2	1210
P51S254C	2x54	T16(T5)	G5	8900	0.50	287	1250	37	5.3	2	1210
P51S235C	2x35	T16(T5)	G5	6600	0.33	287	1550	37	6.7	2	1000
P51S249C	2x49	T16(T5)	G5	8600	0.49	287	1550	37	6.7	2	1000
P51S280C	2x80	T16(T5)	G5	12300	0.76	287	1550	37	6.7	2	1000

V / Hz 220 - 240 / 50 - 60

Opsiyonlar	Options	Options
DIM edilebilir elektronik balast.	Dimmable electronic ballast.	Ballast électronique dimmable.
Acil durum kiti.	Emergency kit.	Kit d'urgence.





ELEGANT

Renk Seçenekleri
Color Options
Options de Couleur



Gümüş
Silver
Argent

Bronz
Bronze



T16 (T5)

Sıva Üstü 2X Alüminyum Reflektörlü
Aydınlatma Armatürleri

Surface Mounted 2X Lighting
Fixtures With Aluminum Reflector

Luminares Apparents 2X Avec
Reflecteur en Aluminium

UYGULAMA ALANLARI

Ofisler
Toplantı Odaları
Mağazalar
Hastaneler
Okullar
Koridorlar

APPLICATION AREAS

Offices
Meeting rooms
Stores
Hospitals
Schools
Corridors

DOMAINES D'UTILISATION

Bureaux
Salles de Réunion
Magasins
Hopitaux
Ecoles
Coulors

GÖVDE

Bronz ve gümüş renk seçenekli, ince (37mm) zarif tasarıma sahip, saten eloksallı alüminyum.

REFLEKTÖR

%99,9 Saflıkta, ayna yüzeyi parlaklığında ve yüksek yansıtma performansına sahip ışığın verimli bir şekilde dağılımını sağlayan zarif tasarımlı eloksallı alüminyum.

BALAST

ENEC standartlarına uygun, uzun ömürlü sabit ışık akısına sahip, düşük enerji kayıplı (EEI=A2) elektronik balast

BODY

Anodized aluminum with satin finishing. Bronze and silver color options with thin (37mm) elegant design.

REFLECTOR

Anodized aluminum with %99,9 purity and with mirror like glossy surface having high reflection performance. Elegant design enables the efficient distribution of the light to the targeted area.

BALLAST

Electronic ballast with long life, low power loss EEI = A2 and constant flux. Compatible with ENEC standards.

CORPS

Corps en aluminium anodisé, satiné. Design Elégant. Couleurs argent et bronze disponibles. Epaisseur : 37 mm.

REFLECTEUR

En aluminium anodisé a 99,9% de pureté et avec une surface brillante comme un miroir assurant un niveau élevé de réflexion. Design Elégant. Permet une répartition efficace de la lumière vers l'endroit ciblé.

BALLAST

Ballast électronique, conforme aux normes ENEC. Longue vie. Perte de puissance faible (EEI=A2). Flux de lumière régulier.

Kod Code	Güç Power Puissance (W)	Ampul Tipi Lamp Type Type De Lampe	Duy Tipi Socket Type Type De Douille	Işık Akısı Lum. Flux Flux Lum. (lm)	Akım Current Courant (A)	Ölçüler Dimensions (mm)			Ağırlık Weight Poids (kg)	Ambalaj Adedi Packing Quantity Colisage	Adet/20" Konteyner Pcs./20" Container Pcs./20" Conteneur
						a	b	h			
P51U214A	2x14	T16(T5)	G5	2400	0.14	287	650	37	2.40	4	2520
P51U224A	2x24	T16(T5)	G5	3500	0.23	287	650	37	2.40	4	2520
P51U221A	2x21	T16(T5)	G5	3800	0.20	287	950	37	3.22	2	1710
P51U228A	2x28	T16(T5)	G5	5200	0.26	287	1250	37	4.11	2	1270
P51U254A	2x54	T16(T5)	G5	8900	0.50	287	1250	37	4.11	2	1270
P51U235A	2x35	T16(T5)	G5	6600	0.33	287	1550	37	5.05	2	1030
P51U249A	2x49	T16(T5)	G5	8600	0.49	287	1550	37	5.05	2	1030
P51U280A	2x80	T16(T5)	G5	12300	0.76	287	1550	37	5.05	2	1030

V / Hz 220 - 240 / 50 - 60

Opsiyonlar	Options	Options
DIM edilebilir elektronik balast.	Dimmable electronic ballast.	Ballast électronique dimmable.
Acil durum kiti.	Emergency kit.	Kit d'urgence.

P51U249A

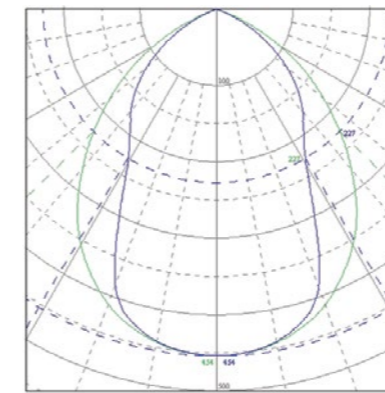

CO - C180
C90 - C270



ELEGANT

Renk Seçenekleri
Color Options
Options de Couleur

Gümüş
Silver
Argent

Bronz
Bronze

LED / T16 (T5)

Sıva Üstü 2X Prizmatik Difüzörlü
Aydınlatma Armatürleri

Surface Mounted 2X Lighting
Fixtures With Prismatic Diffuser

Luminaire Apparents 2X Avec
Diffuseur Prismatique

UYGULAMA ALANLARI

Ofisler
Toplantı Odaları
Mağazalar
Hastaneler
Okullar
Koridorlar

APPLICATION AREAS

Offices
Meeting rooms
Stores
Hospitals
Schools
Corridors

DOMAINES D'UTILISATION

Bureaux
Salles de Réunion
Magasins
Hopitaux
Ecoles
Coulors

GÖVDE

Bronz ve Gümüş renk seçenekli, ince (37mm) zarif tasarıma sahip, saten eloksallı kaplamalı alüminyum.

DİFÜZÖR

UV korumalı akrilik prizmatik difüzör.

BALAST (T5 Modeller İçin)

ENEC standartlarına uygun, uzun ömürlü sabit ışık akısına sahip, düşük enerji kayıplı (EEI=A2) elektronik balast.

KONVERTÖR (LED'li Modeller İçin)

ENEC standartlarına uygun, uzun ömürlü sabit akımlı konvertör.

LED (LED'li Modeller İçin)

50.000 saat ömürlü LUMILEDS / OSRAM / SEOUL marka LED'li LED modülleri.

BODY

Anodized aluminum with satin finishing. Bronze and silver color options with thin (37mm) elegant design.

DIFFUSER

UV stabilized acrylic prismatic diffuser.

BALLAST (For T5 Models)

Electronic ballast with long life, low power loss EEI = A2 and constant flux. Compatible with ENEC standards.

CONVERTER (For LED Models)

Long life, low power loss converter with constant current. Compatible with ENEC standards.

LED (For LED Models)

LED modules with 50,000 hours lifetime LUMILEDS / OSRAM / SEOUL brand LEDs.

CORPS

Corps en aluminium anodisé, satiné. Design Élégant. Couleurs argent et bronze disponibles. Epaisseur : 37mm.

DIFFUSEUR

Diffuseur prismatique en acrylique. Anti UV.

BALLAST (Pour T5 Modèles)

Ballast électronique, conforme aux normes ENEC. Longue vie. Perte de puissance faible (EEI = A2). Flux de lumière régulier.

CONVERTEUR (Pour Modèles LED)

Convertisseur, conforme aux normes ENEC. Longue vie. Perte de puissance faible avec courant constant.

LED (Pour Modèles LED)

Modules LED – Durée de vie 50.000 heures avec LED de marque LUMILEDS / OSRAM / SEOUL.

LED'li Tip / LED Type / Type LED		Renk Geri Verim Indexi / Color Rendering Index / Indice de Rendu des Couleurs: (CRI): Ra>80									
Kod Code	Güç Power Puissance (W)	LED Tipi LED Type Type De LED	LED Modül LED Module Module LED	Işık Akısı Lum. Flux Flux Lum. (lm)	Renk Sıcaklığı Color Temperature Température De Couleur (K)	Ölçüler Dimensions (mm)			Ağırlık Weight Poids (kg)	Ambalaj Adedi Packing Quantity Colisage	Adet/20" Konteyner Pcs./20" Container Pcs./20" Conteneur
						a	b	h			
PL1U21L15C	2x6,5	3535 SMD	PCB	1700	3000 / 4000 / 6500	287	438	37	2.2	4	3680
PL1U22L15C	4x6,5	3535 SMD	PCB	3400	3000 / 4000 / 6500	287	718	37	3.4	4	2250
PL1U23L15C	6x6,5	3535 SMD	PCB	5100	3000 / 4000 / 6500	287	998	37	4.4	2	1620
PL1U24L15C	8x6,5	3535 SMD	PCB	6800	3000 / 4000 / 6500	287	1278	37	5.5	2	1240
PL1U25L15C	10x6,5	3535 SMD	PCB	8500	3000 / 4000 / 6500	287	1558	37	6.8	2	1040

T5 Floresanlı Tip / T5 Fluorescent Type / Type T5 Fluorescent

Kod Code	Güç Power Puissance (W)	Ampul Tipi Lamp Type Type De Lampe	Duy Tipi Socket Type Type De Douille	Işık Akısı Lum. Flux Flux Lum. (lm)	Akım Current Courant (A)	Ölçüler Dimensions (mm)			Ağırlık Weight Poids (kg)	Ambalaj Adedi Packing Quantity Colisage	Adet/20" Konteyner Pcs./20" Container Pcs./20" Conteneur
						a	b	h			
P51U214C	2x14	T16(T5)	G5	2400	0.14	287	650	37	3.1	4	2520
P51U224C	2x24	T16(T5)	G5	3500	0.23	287	650	37	3.1	4	2520
P51U221C	2x21	T16(T5)	G5	3800	0.20	287	950	37	4.4	2	1710
P51U228C	2x28	T16(T5)	G5	5200	0.26	287	1250	37	5.4	2	1270
P51U254C	2x54	T16(T5)	G5	8900	0.50	287	1250	37	5.4	2	1270
P51U235C	2x35	T16(T5)	G5	6600	0.33	287	1550	37	6.8	2	1030
P51U249C	2x49	T16(T5)	G5	8600	0.49	287	1550	37	6.8	2	1030
P51U280C	2x80	T16(T5)	G5	12300	0.76	287	1550	37	6.8	2	1030

P51U249C CO - C180
C90 - C270

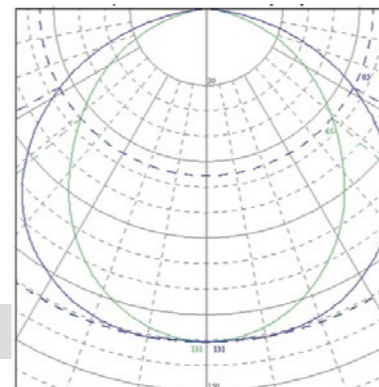

V / Hz 220 - 240 / 50 - 60



Opsiyonlar	Options	Options
DIM edilebilir elektronik balast yada konvertör. LED'li modeller için acil durum kiti.	Dimmable electronic ballast or convertor. Emergency kit for models with LED	Ballast électronique dimmable ou converteur. Kit d'urgence pour les modèles LED.



ELEGANT

Renk Seçenekleri
Color Options
Options de Couleur



Gümüş
Silver
Argent

Bronz
Bronze



T16 (T5)

Sıva Üstü 1X Alüminyum Reflektörlü
Eklenebilir Aydınlatma Armatürleri

Surface Mounted 1X Continuous
Lighting Fixtures With
Aluminum Reflector

Luminaire Continus Apparents
1X Avec Reflecteur en Aluminium

UYGULAMA ALANLARI

Ofisler
Toplantı Odaları
Mağazalar
Hastaneler
Okullar
Koridorlar

APPLICATION AREAS

Offices
Meeting rooms
Stores
Hospitals
Schools
Corridors

DOMAINES D'UTILISATION

Bureaux
Salles de Réunion
Magasins
Hopitaux
Ecoles
Coulors

GÖVDE

Bronz ve gümüş renk seçeneği, ince (37mm) zarif tasarıma sahip, saten eloksallı alüminyum.

REFLEKTÖR

%99,9 Safılıkta, ayna yüzeyi parlaklığında ve yüksek yansıtma performansına sahip ışığın verimli bir şekilde dağılımını sağlayan zarif tasarımı eloksallı alüminyum.

BALAST

ENEC standartlarına uygun, uzun ömürlü sabit ışık akısına sahip, düşük enerji kayıplı (EEI=A2) elektronik balast

BODY

Anodized aluminum with satin finishing. Bronze and silver color options with thin (37mm) elegant design.

REFLECTOR

Anodized aluminum with %99,9 purity and with mirror like glossy surface having high reflection performance. Elegant design enables the efficient distribution of the light to the targeted area.

BALLAST

Electronic ballast with long life, low power loss EEI = A2 and constant flux. Compatible with ENEC standards.

CORPS

Corps en aluminium anodisé, satiné. Design Élégant. Couleurs argent et bronze disponibles. Epaisseur : 37 mm.

REFLECTEUR

En aluminium anodisé a 99,9% de pureté et avec une surface brillante comme un miroir assurant un niveau élevé de réflexion. Design Élégant. Permet une répartition efficace de la lumière vers l'endroit ciblé.

BALLAST

Ballast électronique, conforme aux normes ENEC. Longue vie. Perte de puissance faible (EEI=A2). Flux de lumière régulier.

Kod Code	Güç Power Puissance (W)	Ampul Tipi Lamp Type Typ. De Lamp.	Duy Tipi Socket Type Type De Douille	Işık Akısı Lum. Flux Flux Lum. (lm)	Akım Current Courant (A)	Ölçüler Dimensions (mm)			Ağırlık Weight Poids (kg)	Ambalaj Adedi Packing Quantity Colisage	Adet/20" Konteyner Pcs./20" Container Pcs./20" Conteneur	Resim No Drawing No Dessin No
						a	b	h				
P51U128ASB	1x28	T16(T5)	G5	2600	0.14	165	1214	37	2.58	2	2370	2
P51U128ASO	1x28	T16(T5)	G5	2600	0.14	165	1183	37	2.58	2	2370	1
P51U154ASB	1x54	T16(T5)	G5	4450	0.26	165	1214	37	2.58	2	2370	2
P51U154ASO	1x54	T16(T5)	G5	4450	0.26	165	1183	37	2.58	2	2370	1
P51U135ASB	1x35	T16(T5)	G5	3300	0.17	165	1514	37	3.20	2	1920	2
P51U135ASO	1x35	T16(T5)	G5	3300	0.17	165	1483	37	3.20	2	1920	1
P51U149ASB	1x49	T16(T5)	G5	4300	0.24	165	1514	37	3.20	2	1920	2
P51U149ASO	1x49	T16(T5)	G5	4300	0.24	165	1483	37	3.20	2	1920	1
P51U180ASB	1x80	T16(T5)	G5	6150	0.38	165	1514	37	3.20	2	1920	2
P51U180ASO	1x80	T16(T5)	G5	6150	0.38	165	1483	37	3.20	2	1920	1

V / Hz 220 - 240 / 50 - 60

Opsiyonlar	Options	Options
DIM edilebilir elektronik balast.	Dimmable electronic ballast.	Ballast électronique dimmable.

P51U135A

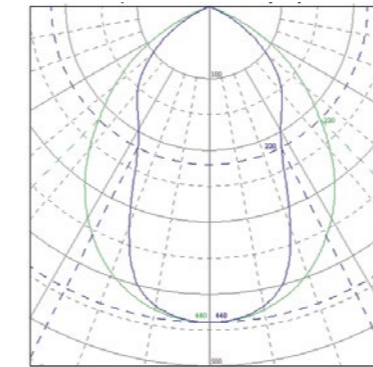

CO - C180
C90 - C270



ELEGANT

Renk Seçenekleri
Color Options
Options de Couleur

Gümüş
Silver
Argent

Bronz
Bronze

LED / T16 (T5)

Sıva Üstü 1X Prizmatik Difüzörlü
Eklenebilir Aydınlatma Armatürleri

Surface Mounted 1X Continuous
Lighting Fixtures With
Prismatic Diffuser

Luminares Continus Apparents
1X Avec Diffuseur Prismatique

UYGULAMA ALANLARI

Ofisler
Toplantı Odaları
Mağazalar
Hastaneler
Okullar
Koridorlar

APPLICATION AREAS

Offices
Meeting rooms
Stores
Hospitals
Schools
Corridors

DOMAINES D'UTILISATION

Bureaux
Salles de Réunion
Magasins
Hopitaux
Ecoles
Coulors

GÖVDE

Bronz ve Gümüş renk seçenekli, ince (37mm) zarif tasarıma sahip, saten eloksal kaplamalı alüminyum.

DİFÜZÖR

UV korumalı akrilik prizmatik difüzör.

BALAST (T5 Modeller İçin)

ENEC standartlarına uygun, uzun ömürlü sabit ışık akısına sahip, düşük enerji kayıplı (EEI=A2) elektronik balast.

KONVERTÖR (LED'li Modeller İçin)

ENEC standartlarına uygun, uzun ömürlü sabit akımlı konvertör.

LED (LED'li Modeller İçin)

50.000 saat ömürlü LUMILEDS / OSRAM / SEOUL marka LED'li LED modüller.

BODY

Anodized aluminum with satin finishing. Bronze and silver color options with thin (37mm) elegant design.

DIFFUSER

UV stablized acrylic prismatic diffuser.

BALLAST (For T5 Models)

Electronic ballast with long life, low power loss EEI = A2 and constant flux. Compatible with ENEC standards.

CONVERTER (For LED Models)

Long life, low power loss converter with constant current. Compatible with ENEC standards.

LED (For LED Models)

LED modules with 50,000 hours lifetime LUMILEDS / OSRAM / SEOUL brand LEDs.

CORPS

Corps en aluminium anodisé, satiné. Design Élégant. Couleurs argent et bronze disponibles. Epaisseur : 37mm.

DIFFUSEUR

Diffuseur prismatique en acrylique . Anti UV.

BALLAST (Pour T5 Modèles)

Ballast électronique , conforme aux normes ENEC. Longue vie. Perte de puissance faible (EEI = A2). Flux de lumière régulier.

CONVERTEUR (Pour Modèles LED)

Convertisseur, conforme aux normes ENEC. Longue vie. Perte de puissance faible avec courant constant .

LED (Pour Modèles LED)

Modules LED – Durée de vie 50.000 heures avec LED de marque LUMILEDS / OSRAM / SEOUL.

LED'li Tip / LED Type / Type LED

Renk Geri Verim Indexi / Color Rendering Index / Indice de Rendu des Couleurs: (CRI): Ra>80

Kod Code	Güç Power Puissance (W)	LED Tipi LED Type Type De LED	LED Modül LED Module Module LED	Işık Akısı Lum. Flux Flux Lum. (lm)	Renk Sıcaklığı Color Temperature Température De Couleur (K)	Ölçüler Dimensions (mm)			Ağırlık Weight Poids (kg)	Ambalaj Adedi Packing Quantity Colisage	Adet/20" Konteyner Pcs./20" Container
						a	b	h			
PL1U14L15CSB	4x6,5	3535 SMD	PCB	3400	3000 / 4000 / 6500	165	1242	37	3.4	2	2300
PL1U14L15CSO	4x6,5	3535 SMD	PCB	3400	3000 / 4000 / 6500	165	1211	37	3.3	2	2300
PL1U15L15CSB	5x6,5	3535 SMD	PCB	4250	3000 / 4000 / 6500	165	1522	37	4.1	2	1900
PL1U15L15CSO	5x6,5	3535 SMD	PCB	4250	3000 / 4000 / 6500	165	1491	37	4.0	2	1900

T5 Floresanlı Tip / T5 Fluorescent Type / Type T5 Fluorescent

Kod Code	Güç Power Puissance (W)	Ampul Tipi Lamp Type Typ. De Lamp.	Duy Tipi Socket Type Type De Douille	Işık Akısı Lum. Flux Flux Lum. (lm)	Akım Current Courant (A)	Ölçüler Dimensions (mm)			Ağırlık Weight Poids (kg)	Ambalaj Adedi Packing Quantity Colisage	Adet/20" Konteyner Pcs./20" Container	Resim No Drawing No Dessin No
						a	b	h				
P51U128CSB	1x28	T16(T5)	G5	2600	0.14	165	1214	37	3.3	2	2370	2
P51U128CSO	1x28	T16(T5)	G5	2600	0.14	165	1183	37	3.3	2	2370	1
P51U154CSB	1x54	T16(T5)	G5	4450	0.26	165	1214	37	3.3	2	2370	2
P51U154CSO	1x54	T16(T5)	G5	4450	0.26	165	1183	37	3.3	2	2370	1
P51U135CSB	1x35	T16(T5)	G5	3300	0.17	165	1514	37	4.1	2	1920	2
P51U135CSO	1x35	T16(T5)	G5	3300	0.17	165	1483	37	4.1	2	1920	1
P51U149CSB	1x49	T16(T5)	G5	4300	0.24	165	1514	37	4.1	2	1920	2
P51U149CSO	1x49	T16(T5)	G5	4300	0.24	165	1483	37	4.1	2	1920	1
P51U180CSB	1x80	T16(T5)	G5	6150	0.38	165	1514	37	4.1	2	1920	2
P51U180CSO	1x80	T16(T5)	G5	6150	0.38	165	1483	37	4.1	2	1920	1

V / Hz 220 - 240 / 50 - 60

CO - C180
P51U135C C90 - C270

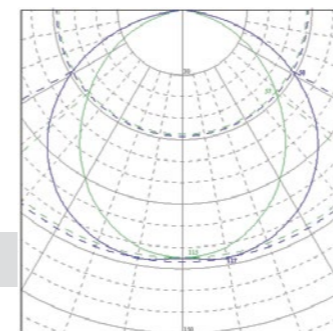

Opsiyonlar	Options	Options
DIM edilebilir elektronik balast yada konvertör. LED'li modeller için acil durum kiti.	Dimmable electronic ballast or convertor. Emergency kit for models with LED	Ballast électronique dimmable ou converteur. Kit d'urgence pour les modèles LED.





ELEGANT

Renk Seçenekleri
Color Options
Options de Couleur

Gümüş
Silver
Argent

Bronz
Bronze

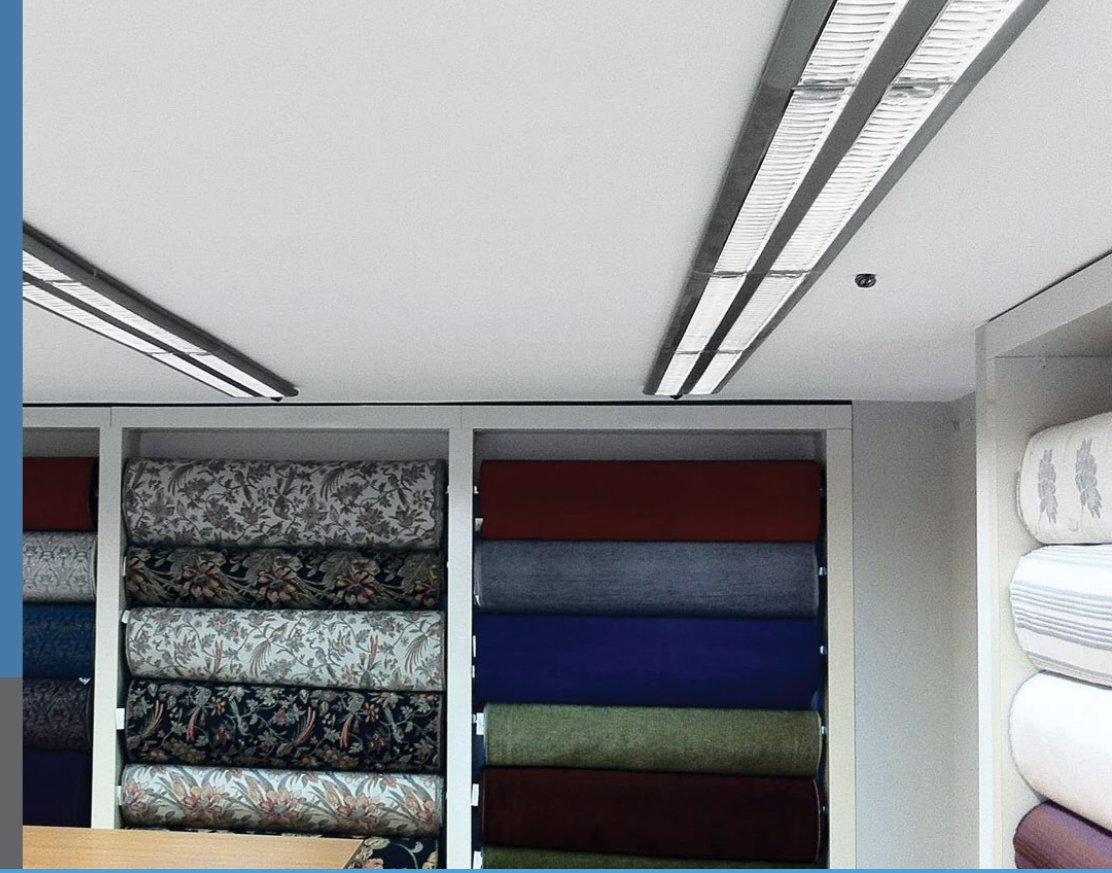

T16 (T5)

Sıva Üstü 2X Alüminyum Reflektörlü
Eklenebilir Aydınlatma Armatürleri

Surface Mounted 2X Continuous
Lighting Fixtures With
Aluminum Reflector

Luminaire Continus Apparents
2X Avec Reflecteur en Aluminium

UYGULAMA ALANLARI

Ofisler
Toplantı Odaları
Mağazalar
Hastaneler
Okullar
Koridorlar

APPLICATION AREAS

Offices
Meeting rooms
Stores
Hospitals
Schools
Corridors

DOMAINES D'UTILISATION

Bureaux
Salles de Réunion
Magasins
Hopitaux
Ecoles
Coulors

GÖVDE

Bronz ve Gümüş renk seçenekli, ince (37mm) zarif tasarıma sahip, saten eloksal kaplamalı alüminyum.

REFLEKTÖR

%99,9 Safılıkta, ayna yüzeyi parlaklığında ve yüksek yansıtma performansına sahip ışığın verimli bir şekilde dağılımını sağlayan zarif tasarımlı eloksal kaplamalı alüminyum.

BALAST

ENEC standartlarına uygun, uzun ömürlü sabit ışık akısına sahip, düşük enerji kayıplı (EEI=A2) elektronik balast

BODY

Anodized aluminum with satin finishing. Bronze and silver color options with thin (37mm) elegant design.

REFLECTOR

Anodized aluminum with %99,9 purity and with mirror like glossy surface having high reflection performance. Elegant design enables the efficient distribution of the light to the targeted area.

BALLAST

Electronic ballast with long life, low power loss EEI = A2 and constant flux. Compatible with ENEC standards.

CORPS

Corps en aluminium anodisé, satiné. Design Élégant. Couleurs argent et bronze disponibles. Epaisseur : 37mm.

REFLECTEUR

En aluminium anodisé a 99,9% de pureté et avec une surface brillante comme un miroir assurant un niveau élevé de réflexion. Design Élégant. Permet une répartition efficace de la lumière vers l'endroit ciblé.

BALLAST

Ballast électronique, conforme aux normes ENEC. Longue vie. Perte de puissance faible (EEI = A2). Flux de lumière régulier.

Kod Code	Güç Power Puissance (W)	Ampul Tipi Lamp Type Typ. De Lamp.	Duy Tipi Socket Type Type De Douille	Işık Akısı Lum. Flux Flux Lum. (lm)	Akım Current Courant (A)	Ölçüler Dimensions (mm)			Ağırlık Weight Poids (kg)	Ambalaj Adedi Packing Quantity Colisage	Adet/20" Konteyner Pcs./20" Conteneur	Resim No Drawing No Dessin No
						a	b	h				
P51U228ASB	2x28	T16(T5)	G5	5200	0.26	287	1214	37	4.11	2	1270	2
P51U228ASO	2x28	T16(T5)	G5	5200	0.26	287	1189	37	4.11	2	1270	1
P51U254ASB	2x54	T16(T5)	G5	8900	0.50	287	1214	37	4.11	2	1270	2
P51U254ASO	2x54	T16(T5)	G5	8900	0.50	287	1189	37	4.11	2	1270	1
P51U235ASB	2x35	T16(T5)	G5	6600	0.33	287	1514	37	5.05	2	1030	2
P51U235ASO	2x35	T16(T5)	G5	6600	0.33	287	1483	37	5.05	2	1030	1
P51U249ASB	2x49	T16(T5)	G5	8600	0.49	287	1514	37	5.05	2	1030	2
P51U249ASO	2x49	T16(T5)	G5	8600	0.49	287	1483	37	5.05	2	1030	1
P51U280ASB	2x80	T16(T5)	G5	12300	0.76	287	1514	37	5.05	2	1030	2
P51U280ASO	2x80	T16(T5)	G5	12300	0.76	287	1483	37	5.05	2	1030	1

V / Hz 220 - 240 / 50 - 60

P51U249A

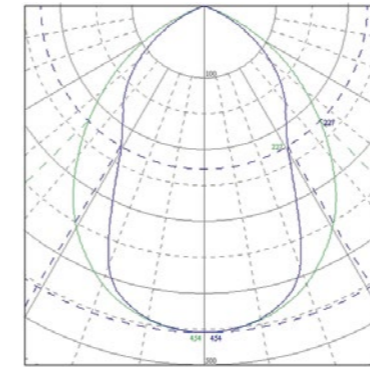

CO - C180
C90 - C270

Opsiyonlar	Options	Options
DIM edilebilir elektronik balast.	Dimmable electronic ballast.	Ballast électronique dimmable.
Acil Durum Kiti.	Emergency Kit.	Kit d'urgence.



ELEGANT

Renk Seçenekleri
Color Options
Options de Couleur

Gümüş
Silver
Argent

Bronz
Bronze

LED / T16 (T5)

Sıva Üstü 2X Prizmatik Difüzörlü
Eklenebilir Aydınlatma Armatürleri

Surface Mounted 2X Continuous
Lighting Fixtures With
Prismatic Diffuser

Luminaire Continus Apparents 2X
Avec Diffuseur Prismatique

UYGULAMA ALANLARI

Ofisler
Toplantı Odaları
Mağazalar
Hastaneler
Okullar
Koridorlar

APPLICATION AREAS

Offices
Meeting rooms
Stores
Hospitals
Schools
Corridors

DOMAINES D'UTILISATION

Bureaux
Salles de Réunion
Magasins
Hopitaux
Ecoles
Coulloirs

GÖVDE

Bronz ve gümüş renk seçeneği, ince (37mm) zarif tasarıma sahip, saten eloksallı kaplamalı alüminyum.

DİFÜZÖR

UV korumalı akrilik prizmatik difüzör.

BALAST (T5 Modeller için)

ENEC standartlarına uygun, uzun ömürlü sabit ışık akısına sahip, düşük enerji kayıplı (EEI=A2) elektronik balast.

KONVERTÖR (LED'li Modeller için)

ENEC standartlarına uygun, uzun ömürlü sabit akımlı konvertör.

LED (LED'li Modeller için)

50.000 saat ömürlü LUMILEDS / OSRAM / SEOUL marka LED'li LED modüller.

BODY

Anodized aluminum with satin finishing. Bronze and silver color options with thin (37mm) elegant design.

DIFFUSER

UV stabilized acrylic prismatic diffuser.

BALLAST (For T5 Models)

Electronic ballast with long life, low power loss EEI = A2 and constant flux. Compatible with ENEC standards.

CONVERTER (For LED Models)

Long life, low power loss converter with constant current. Compatible with ENEC standards.

LED (For LED Models)

LED modules with 50,000 hours lifetime LU-MILEDS / OSRAM / SEOUL brand LEDs.

CORPS

Corps en aluminium anodisé, satiné. Design élégant. Couleurs argent et bronze disponibles. Epaisseur : 37mm.

DIFFUSEUR

Diffuseur prismatique en acrylique. Anti UV.

BALLAST (Pour T5 Modèles)

Ballast électronique, conforme aux normes ENEC. Longue vie. Perte de puissance faible (EEI = A2). Flux de lumière régulier.

CONVERTEUR (Pour Modèles LED)

Convertisseur, conforme aux normes ENEC. Longue vie. Perte de puissance faible avec courant constant.

LED (Pour Modèles LED)

Modules LED – Durée de vie 50.000 heures avec LED de marque LUMILEDS / OSRAM / SEOUL.

LED'li Tip / LED Type / Type LED

Renk Geri Verim Indexi / Color Rendering Index / Indice de Rendu des Couleurs: (CRI): Ra>80

Kod Code	Güç Power Puissance (W)	LED Tipi LED Type Type De LED	LED Modül LED Module Module LED	Işık Akısı Lum. Flux Flux Lum. (lm)	Renk Sıcaklığı Color Temperature Température De Couleur (K)	Ölçüler Dimensions (mm)			Ağırlık Weight Poids (kg)	Ambalaj Adedi Packing Quantity Colisage	Adet/20" Konteyner Pcs./20" Conteneur
						a	b	h			
PL1U24L15CSB	8x6,5	3535 SMD	PCB	6800	3000 / 4000 / 6500	287	1242	37	5.3	2	1240
PL1U24L15CSO	8x6,5	3535 SMD	PCB	6800	3000 / 4000 / 6500	287	1211	37	5.2	2	1240
PL1U25L15CSB	10x6,5	3535 SMD	PCB	8500	3000 / 4000 / 6500	287	1522	37	6.6	2	1040
PL1U25L15CSO	10x6,5	3535 SMD	PCB	8500	3000 / 4000 / 6500	287	1491	37	6.5	2	1040

T5 Floresanlı Tip / T5 Fluorescent Type / Type T5 Fluorescent

Kod Code	Güç Power Puissance (W)	Ampul Tipi Lamp Type Typ. De Lamp.	Duy Tipi Socket Type Type De Douille	Işık Akısı Lum. Flux Flux Lum. (lm)	Akım Current Courant (A)	Ölçüler Dimensions (mm)			Ağırlık Weight Poids (kg)	Ambalaj Adedi Packing Quantity Colisage	Adet/20" Konteyner Pcs./20" Conteneur	Resim No Drawing No Dessin No
						a	b	h				
P51U228CSB	2x28	T16(T5)	G5	5200	0.26	287	1214	37	5.4	2	1270	2
P51U228CSO	2x28	T16(T5)	G5	5200	0.26	287	1183	37	5.4	2	1270	1
P51U254CSB	2x54	T16(T5)	G5	8900	0.50	287	1214	37	5.4	2	1270	2
P51U254CSO	2x54	T16(T5)	G5	8900	0.50	287	1183	37	5.4	2	1270	1
P51U235CSB	2x35	T16(T5)	G5	6600	0.33	287	1514	37	6.8	2	1030	2
P51U235CSO	2x35	T16(T5)	G5	6600	0.33	287	1483	37	6.8	2	1030	1
P51U249CSB	2x49	T16(T5)	G5	8600	0.49	287	1514	37	6.8	2	1030	2
P51U249CSO	2x49	T16(T5)	G5	8600	0.49	287	1483	37	6.8	2	1030	1
P51U280CSB	2x80	T16(T5)	G5	12300	0.76	287	1514	37	6.8	2	1030	2
P51U280CSO	2x80	T16(T5)	G5	12300	0.76	287	1483	37	6.8	2	1030	1

V / Hz 220 - 240 / 50 - 60

CO - C180
P51U249C C90 - C270

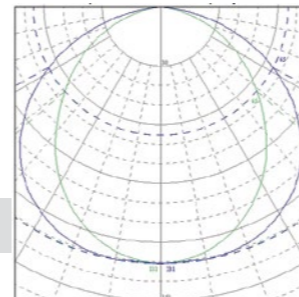

Opsiyonlar	Options	Options
DIM edilebilir elektronik balast yada konvertör. LED'li modeller için acil durum kit.	Dimmable electronic ballast or convertor. Emergency kit for models with LED.	Ballast Dimmable ou converteur. Kit d'urgence pour les modèles LED.





ELEGANT

Renk Seçenekleri
Color Options
Options de Couleur

Gümüş
Silver
Argent

Bronz
Bronze



T16 (T5)

Sıva Üstü 4X A Tipi Alüminyum Reflektörlü Aydınlatma Armatürleri

Surface Mounted 4X A Type Lighting Fixtures With Aluminum Reflector

Luminaire Apparents Type 4X A Avec Reflecteur en Aluminium

UYGULAMA ALANLARI

Ofisler
Toplantı Odaları
Mağazalar
Hastaneler
Okullar
Koridorlar

APPLICATION AREAS

Offices
Meeting rooms
Stores
Hospitals
Schools
Corridors

DOMAINES D'UTILISATION

Bureaux
Salles de Réunion
Magasins
Hopitaux
Ecoles
Coulors

GÖVDE

Bronz ve Gümüş renk seçeneği, ince (37mm) zarif tasarıma sahip, saten eloksallı alüminyum.

REFLEKTÖR

%99,9 Safılıkta, ayna yüzeyi parlaklığında ve yüksek yansıtma performansına sahip ışığın verimli bir şekilde dağılımını sağlayan zarif tasarımlı eloksallı alüminyum.

BALAST

ENEC standartlarına uygun, uzun ömürlü, sabit ışık akısına sahip, düşük enerji kayıplı (EEI = A2) elektronik balast.

BODY

Anodized aluminum with satin finishing. Bronze and silver color options with thin (37mm) elegant design.

REFLECTOR

Anodized aluminum with %99,9 purity and with mirror like glossy surface having high reflection performance. Elegant design enables the efficient distribution of the light to the targeted area.

BALLAST

Electronic ballast with long life, low power loss EEI = A2 and constant flux. Compatible with ENEC standards.

CORPS

Corps en aluminium anodisé, satiné. Design Élégant. Couleurs argent et bronze disponibles. Epaisseur : 37 mm.

REFLECTEUR

En aluminium anodisé a 99,9% de pureté et avec une surface brillante comme un miroir assurant un niveau élevé de réflexion. Design Élégant. Permet une répartition efficace de la lumière vers l'endroit ciblé.

BALLAST

Ballast électronique, conforme aux normes ENEC. Longue vie. Perte de puissance faible (EEI=A2). Flux de lumière régulier.

Kod Code	Güç Power Puissance (W)	Ampul Tipi Lamp Type Type De Lampe	Duy Tipi Socket Type Type De Douille	Işık Akısı Lum. Flux Flux Lum. (lm)	Akım Current Courant (A)	Ölçüler Dimensions (mm)			Ağırlık Weight Poids (kg)	Ambalaj Adedi Packing Quantity Colisage	Adet/20" Konteyner Pcs./20" Container Pcs./20" Conteneur
						a	b	h			
P51U414A	4x14	T16(T5)	G5	4800	0.28	486	650	37	3.5	2	1450
P51U424A	4x24	T16(T5)	G5	7000	0.46	486	650	37	3.5	2	1450
P51U421A	4x21	T16(T5)	G5	7600	0.40	486	950	37	5.0	2	1020
P51U428A	4x28	T16(T5)	G5	10400	0.52	486	1250	37	6.2	2	780
P51U454A	4x54	T16(T5)	G5	17800	1.00	486	1250	37	6.2	2	780
P51U435A	4x35	T16(T5)	G5	13200	0.66	486	1550	37	7.7	2	630
P51U449A	4x49	T16(T5)	G5	17200	0.98	486	1550	37	7.7	2	630
P51U480A	4x80	T16(T5)	G5	24600	1.52	486	1550	37	7.7	2	630

V / Hz 220 - 240 / 50 - 60

Opsiyonlar	Options	Options
DIM edilebilir elektronik balast.	Dimmable electronic ballast.	Ballast électronique dimmable.
Acil Durum Kiti.	Emergency Kit.	Kit d'urgence.

P51U414A

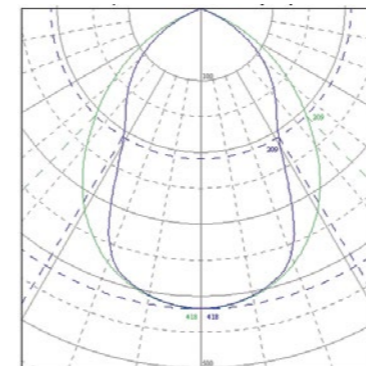

C0 - C180

C90 - C270

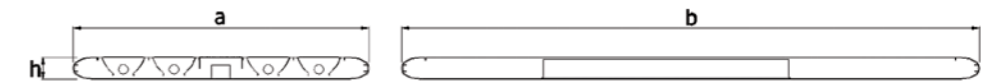



ELEGANT

Renk Seçenekleri
Color Options
Options de Couleur

Gümüş
Silver
Argent

Bronz
Bronze



T16 (T5)

Sıva Üstü 4X B Tipi Alüminyum
Reflektörlü Aydınlatma Armatürleri

Surface Mounted 4X B Type Lighting
Fixtures With Aluminum Reflector

Luminaire Apparents Type 4X B Avec
Reflecteur en Aluminium

UYGULAMA ALANLARI

Ofisler
Toplantı Odaları
Mağazalar
Hastaneler
Okullar
Koridorlar

APPLICATION AREAS

Offices
Meeting rooms
Stores
Hospitals
Schools
Corridors

DOMAINES D'UTILISATION

Bureaux
Salles de Réunion
Magasins
Hopitaux
Ecoles
Couloirs

GÖVDE

Bronz ve Gümüş renk seçenekli, ince (37mm) zarif tasarıma sahip, saten eloksallı alüminyum.

REFLEKTÖR

%99 Safılıkta, ayna yüzeyi parlaklığında ve yüksek yansıtma performansına sahip ışığın verimli bir şekilde dağılımını sağlayan zarif tasarımlı eloksallı alüminyum.

BALAST

ENEC standartlarına uygun, uzun ömürlü sabit ışık akısına sahip, düşük enerji kayıplı (EEI=A2) elektronik balast

BODY

Anodized aluminum with satin finishing. Bronze and silver color options with thin (37mm) elegant design.

REFLECTOR

Anodized aluminum with %99,9 purity and with mirror like glossy surface having high reflection performance. Elegant design enables the efficient distribution of the light to the targeted area.

BALLAST

Electronic ballast with long life, low power loss EEI = A2 and constant flux. Compatible with ENEC standards.

CORPS

Corps en aluminium anodisé, satiné. Design Élégant. Couleurs argent et bronze disponibles. Epaisseur : 37 mm.

REFLECTEUR

En aluminium anodisé a 99,9% de pureté et avec une surface brillante comme un miroir assurant un niveau élevé de réflexion. Design Élégant. Permet une répartition efficace de la lumière vers l'endroit ciblé.

BALLAST

Ballast électronique, conforme aux normes ENEC. Longue vie. Perte de puissance faible (EEI=A2). Flux de lumière régulier.

Kod Code	Güç Power Puissance (W)	Ampul Tipi Lamp Type Type De Lampe	Duy Tipi Socket Type Type De Douille	Işık Akısı Lum. Flux Flux Lum. (lm)	Akım Current Courant (A)	Ölçüler Dimensions (mm)			Ağırlık Weight Poids (kg)	Ambalaj Adedi Packing Quantity Colisage	Adet/20" Konteyner Pcs./20" Conteneur
						a	b	h			
P51U414B	4x14	T16(T5)	G5	4800	0.28	515	650	37	3.69	2	1450
P51U424B	4x24	T16(T5)	G5	7000	0.46	515	650	37	3.69	2	1450
P51U421B	4x21	T16(T5)	G5	7600	0.40	515	950	37	5.23	2	1020
P51U428B	4x28	T16(T5)	G5	10400	0.52	515	1250	37	6.43	2	780
P51U454B	4x54	T16(T5)	G5	17800	1.00	515	1250	37	6.43	2	780
P51U435B	4x35	T16(T5)	G5	13200	0.66	515	1550	37	7.95	2	630
P51U449B	4x49	T16(T5)	G5	17200	0.98	515	1550	37	7.95	2	630
P51U480B	4x80	T16(T5)	G5	24600	1.52	515	1550	37	7.95	2	630

V / Hz 220 - 240 / 50 - 60

Opsiyonlar	Options	Options
DIM edilebilir elektronik balast. Acil Durum Kiti.	Dimmable electronic ballast. Emergency Kit.	Ballast électronique dimmable. Kit d'urgence.

P51U414B

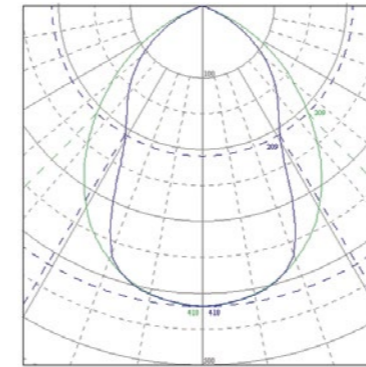

CO - C180
C90 - C270





ELEGANT

Renk Seçenekleri
Color Options
Options de Couleur

Gümüş
Silver
Argent

Bronz
Bronze



LED / T16 (T5)

Sıva Üstü 4X Prizmatik Difüzörlü
Aydınlatma Armatürleri

Surface Mounted 4X Lighting
Fixtures With Prismatic Diffuser

Luminaire Apparents 4X avec
Diffuseur Prismatique

UYGULAMA ALANLARI

Ofisler
Toplantı odaları
Mağazalar
Hastaneler
Okullar
Koridorlar

APPLICATION AREAS

Offices
Meeting rooms
Stores
Hospitals
Schools
Corridors

DOMAINES D'UTILISATION

Bureaux
Salles de Réunion
Magasins
Hopitaux
Ecoles
Coulors

GÖVDE

Bronz ve Gümüş renk seçeneği, ince (37mm) zarif tasarıma sahip, saten eloksallı kaplamalı alüminyum.

DİFÜZÖR

UV korumalı akrilik prizmatik difüzör.

BALAST (T5 Modeller İçin)

ENEC standartlarına uygun, uzun ömürlü sabit ışık akısına sahip, düşük enerji kayıplı (EEI=A2) elektronik balast.

KONVERTÖR (LED'li Modeller İçin)

ENEC standartlarına uygun, uzun ömürlü sabit akımlı konvertör.

LED (LED'li Modeller İçin)

50.000 saat ömürlü LUMILEDS / OSRAM / SEOUL marka LED'li LED modülleri.

BODY

Anodized aluminum with satin finishing. Bronze and silver color options with thin (37mm) elegant design.

DIFFUSER

UV stabilized acrylic prismatic diffuser.

BALLAST (For T5 Models)

Electronic ballast with long life, low power loss EEI = A2 and constant flux. Compatible with ENEC standards.

CONVERTER (For LED Models)

Long life, low power loss converter with constant current. Compatible with ENEC standards.

LED (For LED Models)

LED modules with 50,000 hours lifetime LUMILEDS / OSRAM / SEOUL brand LEDs.

CORPS

Corps en aluminium anodisé, satiné. Design Élégant. Couleurs argent et bronze disponibles. Epaisseur : 37mm.

DIFFUSEUR

Diffuseur prismatique en acrylique. Anti UV.

BALLAST (Pour T5 Modèles)

Ballast électronique, conforme aux normes ENEC. Longue vie. Perte de puissance faible (EEI = A2). Flux de lumière régulier.

CONVERTEUR (Pour Modèles LED)

Convertisseur, conforme aux normes ENEC. Longue vie. Perte de puissance faible avec courant constant.

LED (Pour Modèles LED)

Modules LED – Durée de vie 50.000 heures avec LED de marque LUMILEDS / OSRAM / SEOUL.

LED'li Tip / LED Type / Type LED

Renk Geri Verim Indexi / Color Rendering Index / Indice de Rendu des Couleurs: (CRI): Ra>80

Kod Code	Güç Power Puissance (W)	LED Tipi LED Type Type De LED	LED Modül LED Module Module LED	Işık Akısı Lum. Flux Flux Lum. (lm)	Renk Sıcaklığı Color Temperature Température De Couleur (K)	Ölçüler Dimensions (mm)			Ağırlık Weight Poids (kg)	Ambalaj Adedi Packing Quantity Colisage	Adet/20" Konteyner Pcs./20" Container
						a	b	h			
PL1U42L15C	8x6,5	3535 SMD	PCB	6800	3000 / 4000 / 6500	486	718	37	5.2	2	1300
PL1U43L15C	12x6,5	3535 SMD	PCB	10200	3000 / 4000 / 6500	486	998	37	7.0	2	1070
PL1U44L15C	16x6,5	3535 SMD	PCB	13600	3000 / 4000 / 6500	486	1278	37	8.7	2	760
PL1U45L15C	20x6,5	3535 SMD	PCB	17000	3000 / 4000 / 6500	486	1558	37	10.5	2	630

T5 Floresanlı Tip / T5 Fluorescent Type / Type T5 Fluorescent

Kod Code	Güç Power Puissance (W)	Ampul Tipi Lamp Type Type De Lampe	Duy Tipi Socket Type Type De Douille	Işık Akısı Lum. Flux Flux Lum. (lm)	Akım Current Courant (A)	Ölçüler Dimensions (mm)			Ağırlık Weight Poids (kg)	Ambalaj Adedi Packing Quantity Colisage	Adet/20" Konteyner Pcs./20" Container
						a	b	h			
P51U414C	4x14	T16(T5)	G5	4800	0.28	486	650	37	4.7	2	1450
P51U424C	4x24	T16(T5)	G5	7000	0.46	486	650	37	4.7	2	1450
P51U421C	4x21	T16(T5)	G5	7600	0.40	486	950	37	6.7	2	1020
P51U428C	4x28	T16(T5)	G5	10400	0.52	486	1250	37	8.5	2	780
P51U454C	4x54	T16(T5)	G5	17800	1.00	486	1250	37	8.5	2	780
P51U435C	4x35	T16(T5)	G5	13200	0.66	486	1550	37	10.5	2	630
P51U449C	4x49	T16(T5)	G5	17200	0.98	486	1550	37	10.5	2	630
P51U480C	4x80	T16(T5)	G5	24600	1.52	486	1550	37	10.5	2	630

V / Hz 220 - 240 / 50 - 60

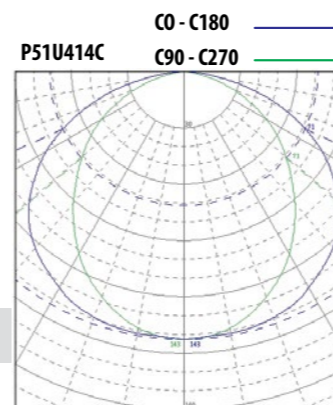

Opsiyonlar	Options	Options
DIM edilebilir elektronik balast yada konvertör. LED'li modeller için acil durum kiti.	Dimmable electronic ballast or convertor. Emergency kit for models with LED.	Ballast électronique dimmable ou converteur. Kit d'urgence pour les modèles LED.

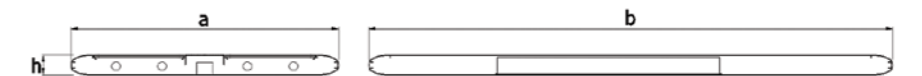



 pamir®
aydınlatma

APLIK / APPLIQUE



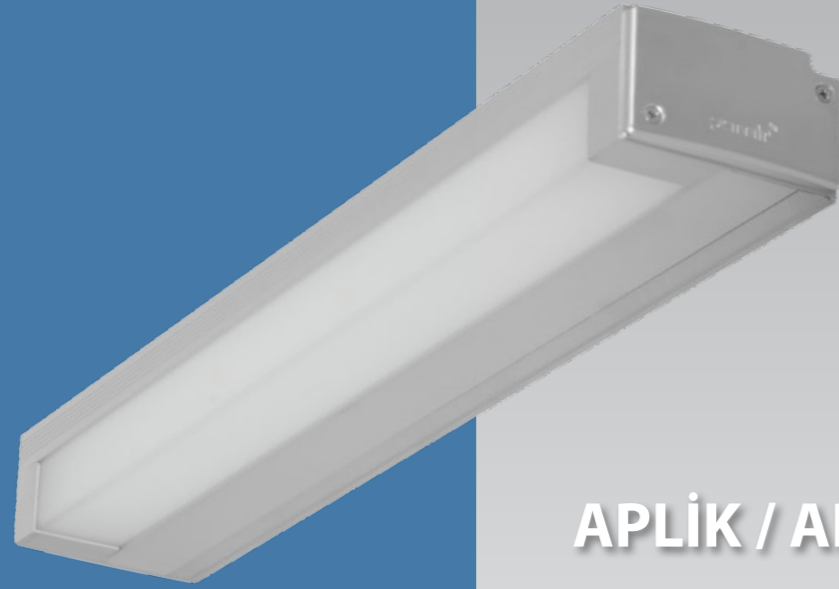

APLIK / APPLIQUE

Renk Seçenekleri
Color Options
Options de Couleur



LED / T16 (T5)

Ayna Üstü Buzlu Akrilik Difüzörlü
Aplik Aydınlatma Armatürleri

Mirror Type Applique Lighting
Fixtures With Frosted Acrylic Diffuser

Applique Pour Miroir Avec
Diffuseur Acrylique Givré

UYGULAMA ALANLARI

Lavabolar
Banyolar
Ofisler
Toplantı Odaları
Mağazalar
Hastaneler
Okullar
Koridorlar

APPLICATION AREAS

Washbasins
Bathrooms
Offices
Meeting rooms
Stores
Hospitals
Schools
Corridors

DOMAINES D'UTILISATION

Lavabos
Salles de Bain
Bureaux
Salles de Réunions
Magasins
Hopitaux
Ecoles
Couloirs

GÖVDE

Beyaz, gümüş, siyah renk seçenekleri ile zarif tasarıma sahip alüminyum.

DİFÜZÖR

UV korumalı akrilik difüzör.

BALAST (T5 Modeller İçin)

ENEC standartlarına uygun, uzun ömürlü sabit ışık akısına sahip, düşük enerji kayıplı (EEI=A2) elektronik balast.

KONVERTÖR (LED'li Modeller İçin)

ENEC standartlarına uygun, uzun ömürlü sabit akımlı konvertör.

LED (LED'li Modeller İçin)

50.000 saat ömürlü LUMILEDS / OSRAM / SEOUL marka LED'li LED modüller.

BODY

Anodized aluminum with satin finishing. Black, white and silver color options with elegant design.

DIFFUSER

UV stabilized acrylic diffuser.

BALLAST (For T5 Models)

Electronic ballast with long life, low power loss EEI = A2 and constant flux. Compatible with ENEC standards.

CONVERTER (For LED Models)

Long life, low power loss converter with constant current. Compatible with ENEC standards.

LED (For LED Models)

LED modules with 50,000 hours lifetime LUMILEDS / OSRAM / SEOUL brand LEDs.

CORPS

Corps en aluminium anodisé, satiné. Design élégant. Couleurs blanc, argent, noir disponibles.

DIFFUSEUR

Diffuseur en acrylique. Anti UV.

BALLAST (Pour T5 Modèles)

Ballast électronique, conforme aux normes ENEC. Longue vie. Perte de puissance faible (EEI = A2). Flux de lumière régulier.

CONVERTEUR (Pour Modèles LED)

Convertisseur, conforme aux normes ENEC. Longue vie. Perte de puissance faible avec courant constant.

LED (Pour Modèles LED)

Modules LED – Durée de vie 50.000 heures avec LED de marque LUMILEDS / OSRAM / SEOUL.

LED'li Tip / LED Type / Type LED

Renk Geri Verim Indexi / Color Rendering Index / Indice de Rendu des Couleurs: (CRI): Ra>80

Kod Code	Güç Power Puissance (W)	LED Tipi LED Type Type De LED	LED Modül LED Module Module LED	Işık Akısı Lum. Flux Flux Lum. (lm)	Renk Sıcaklığı Color Temperature Température De Couleur (K)	Ölçüler Dimensions (mm)			Ağırlık Weight Poids (kg)	Ambalaj Adedi Packing Quantity Colisage	Adet/20" Konteyner Pcs./20" Container Pcs./20" Conteneur
						a	b	h			
PL5U11L15C	1x6,5	3535 SMD	PCB	850	3000 / 4000 / 6500	104	310	60	1.3	2	11200
PL5U12L15C	2x6,5	3535 SMD	PCB	1700	3000 / 4000 / 6500	104	590	60	1.7	2	6000
PL5U13L15C	3x6,5	3535 SMD	PCB	2550	3000 / 4000 / 6500	104	870	60	2.0	2	4000
PL5U14L15C	4x6,5	3535 SMD	PCB	3400	3000 / 4000 / 6500	104	1151	60	2.4	2	3000

T5 Floresanlı Tip / T5 Fluorescent Type / Type T5 Fluorescent

Kod Code	Güç Power Puissance (W)	Ampul Tipi Lamp Type Type De Lampe	Duy Tipi Socket Type Type De Douille	Işık Akısı Lum. Flux Flux Lum. (lm)	Akım Current Courant (A)	Ölçüler Dimensions (mm)			Ağırlık Weight Poids (kg)	Ambalaj Adedi Packing Quantity Colisage	Adet/20" Konteyner Pcs./20" Container Pcs./20" Conteneur
						a	b	h			
P55U114C	1x14	T16(T5)	G5	1200	0.08	104	590	60	1.7	2	6000
P55U124C	1x24	T16(T5)	G5	1750	0.12	104	590	60	1.7	2	6000
P55U121C	1x21	T16(T5)	G5	1900	0.11	104	890	60	2.1	2	4000
P55U128C	1x28	T16(T5)	G5	2600	0.14	104	1190	60	2.5	2	3000
P55U154C	1x54	T16(T5)	G5	4450	0.26	104	1190	60	2.5	2	3000

V / Hz 220 - 240 / 50 - 60

Opsiyonlar	Options	Options
DIM edilebilir elektronik balast yada konvertör. LED'li modeller için acil durum kiti.	Dimmable electronic ballast or convertor. Emergency kit for models with LED	Ballast électronique dimmable ou converteur. Kit d'urgence pour les modèles LED.





APLIK / APPLIQUE

Renk Seçenekleri
Color Options
Options de Couleur



LED / T16 (T5)

Buzlu Akrilik Difüzörlü Aplik
Aydınlatma Armatürleri

Applique Lighting Fixtures
With Frosted Acrylic Diffuser

Luminaire Applique Avec
Diffuseur Acrylique Givré

UYGULAMA ALANLARI

Alışveriş Merkezleri
Marketler
Ofisler
Toplantı Odaları
Mağazalar
Hastaneler
Okullar
Koridorlar

APPLICATION AREAS

Shopping Malls
Supermarkets
Offices
Meeting rooms
Stores
Hospitals
Schools
Corridors

DOMAINES D'UTILISATION

Centres Commerciaux
Supermarchés
Bureaux
Salles de Réunions
Magasins
Hopitaux
Ecoles
Couloirs

GÖVDE

Beyaz, gümüş, siyah renk seçenekleri ile zarif tasarıma sahip alüminyum.

DİFÜZÖR

UV korumalı akrilik difüzör.

BALAST (T5 Modeller İçin)

ENEC standartlarına uygun, uzun ömürlü sabit ışık akısına sahip, düşük enerji kayıplı (EEI=A2) elektronik balast.

KONVERTÖR (LED'li Modeller İçin)

ENEC standartlarına uygun, uzun ömürlü sabit akımlı konvertör.

LED (LED'li Modeller İçin)

50.000 saat ömürlü LUMILEDS / OSRAM / SEOUL marka LED'li LED modülleri.

BODY

Anodized aluminum with satin finishing. Black, white and silver options with elegant design.

DIFFUSER

UV stabilized acrylic diffuser.

BALLAST (For T5 Models)

Electronic ballast with long life, low power loss EEI = A2 and constant flux. Compatible with ENEC standards.

CONVERTER (For LED Models)

Long life, low power loss converter with constant current. Compatible with ENEC standards.

LED (For LED Models)

LED modules with 50,000 hours lifetime LUMILEDS / OSRAM / SEOUL brand LEDs.

CORPS

Corps en aluminium anodisé, satiné. Design élégant. Couleurs blanc, argent, noir disponibles.

DIFFUSEUR

Diffuseur en acrylique. Anti UV.

BALLAST (Pour T5 Modèles)

Ballast électronique, conforme aux normes ENEC. Longue vie. Perte de puissance faible (EEI = A2). Flux de lumière régulier.

CONVERTEUR (Pour Modèles LED)

Convertisseur, conforme aux normes ENEC. Longue vie. Perte de puissance faible avec courant constant.

LED (Pour Modèles LED)

Modules LED – Durée de vie 50.000 heures avec LED de marque LUMILEDS / OSRAM / SEOUL.

LED'li Tip / LED Type / Type LED

Renk Geri Verim Indexi / Color Rendering Index / Indice de Rendu des Couleurs: (CRI): Ra>80

Kod Code	Güç Power Puissance (W)	LED Tipi LED Type Type De LED	LED Modül LED Module Module LED	Işık Akısı Lum. Flux Flux Lum. (lm)	Renk Sıcaklığı Color Temperature Température De Couleur (K)	Ölçüler Dimensions (mm)			Ağırlık Weight Poids (kg)	Ambalaj Adedi Packing Quantity Colisage	Adet/20" Konteyner Pcs./20" Container Pcs./20" Conteneur
						a	b	h			
PL6U21L15C	2x6,5	3535 SMD	PCB	1700	3000 / 4000 / 6500	104	308	48	0.9	2	11200
PL6U22L15C	4x6,5	3535 SMD	PCB	3400	3000 / 4000 / 6500	104	588	48	1.5	2	6000
PL6U23L15C	6x6,5	3535 SMD	PCB	5100	3000 / 4000 / 6500	104	868	48	2.2	2	4000
PL6U24L15C	8x6,5	3535 SMD	PCB	6800	3000 / 4000 / 6500	104	1149	48	2.9	2	3000

T5 Floresanlı Tip / T5 Fluorescent Type / Type T5 Fluorescent

Kod Code	Güç Power Puissance (W)	Ampul Tipi Lamp Type Type De Lampe	Duy Tipi Socket Type Type De Douille	Işık Akısı Lum. Flux Flux Lum. (lm)	Akım Current Courant (A)	Ölçüler Dimensions (mm)			Ağırlık Weight Poids (kg)	Ambalaj Adedi Packing Quantity Colisage	Adet/20" Konteyner Pcs./20" Container Pcs./20" Conteneur
						a	b	h			
P56U114C	1x14	T16(T5)	G5	1200	0.08	104	588	48	1.5	2	6000
P56U124C	1x24	T16(T5)	G5	1750	0.12	104	588	48	1.5	2	6000
P56U121C	1x21	T16(T5)	G5	1900	0.11	104	888	48	2.3	2	4000
P56U128C	1x28	T16(T5)	G5	2600	0.14	104	1188	48	3.0	2	3000
P56U154C	1x54	T16(T5)	G5	4450	0.26	104	1188	48	3.0	2	3000

V / Hz 220 - 240 / 50 - 60

Opsiyonlar	Options	Options
DIM edilebilir elektronik balast yada konvertör.	Dimmable electronic ballast or convertor.	Ballast électronique dimmable ou converteur.
LED'li modeller için acil durum kiti.	Emergency kit for models with LED	Kit d'urgence pour les modèles LED.

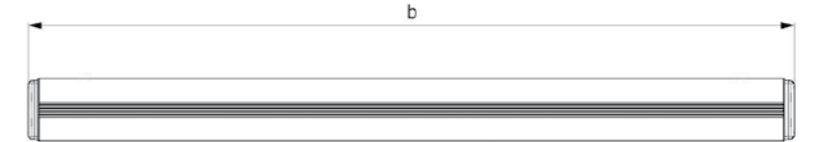
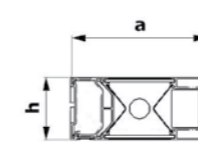



APLIK / APPLIQUE

Renk Seçenekleri
Color Options
Options de Couleur



LED / T16 (T5)

Mutfak Tipi Buzlu Akrilik Difüzörlü
Aplik Aydınlatma Armatürleri
Kitchen Type Applique Lighting
Fixture With Frosted Acrylic
Diffuser
Applique Pour Cuisine Avec
Diffuseur Acrylique Givré

UYGULAMA ALANLARI

Mutfak Dolap Altları
Raf Altları
Alışveriş Merkezleri
Marketler
Ofisler
Toplantı Odaları
Mağazalar
Hastaneler
Okullar
Koridorlar

APPLICATION AREAS

Under Kitchen Cabinets
Under Shelves
Shopping Malls
Supermarkets
Offices
Meeting rooms
Stores
Hospitals
Schools
Corridors

DOMAINES D'UTILISATION

Sous Placards de Cuisine
Sous Etagères
Centres Commerciaux
Supermarchés
Bureaux
Salles de Réunions
Magasins
Hopitaux
Ecoles
Couloirs

GÖVDE

Beyaz, gümüş, siyah renk seçenekleri ile zarif tasarıma sahip alüminyum.

DİFÜZÖR

UV korumalı akrilik difüzör.

BALAST (T5 Modeller İçin)

ENEC standartlarına uygun, uzun ömürlü sabit ışık akısına sahip, düşük enerji kayıplı (EEI=A2) elektronik balast.

KONVERTÖR (LED'li Modeller İçin)

ENEC standartlarına uygun, uzun ömürlü sabit akımlı konvertör.

LED (LED'li Modeller İçin)

50.000 saat ömürlü LUMILEDS / OSRAM / SEOUL marka LED'li LED modülleri.

BODY

Anodized aluminum with satin finishing. Black, white and silver options with elegant design.

DIFFUSER

UV stabilized acrylic diffuser.

BALLAST (For T5 Models)

Electronic ballast with long life, low power loss EEI = A2 and constant flux. Compatible with ENEC standards.

CONVERTER (For LED Models)

Long life, low power loss converter with constant current. Compatible with ENEC standards.

LED (For LED Models)

LED modules with 50,000 hours lifetime LUMILEDS / OSRAM / SEOUL brand LEDs.

CORPS

Corps en aluminium anodisé, satiné. Design élégant. Couleurs blanc, argent, noir disponibles.

DIFFUSEUR

Diffuseur en acrylique. Anti UV.

BALLAST (Pour T5 Modèles)

Ballast électronique, conforme aux normes ENEC. Longue vie. Perte de puissance faible (EEI = A2). Flux de lumière régulier.

CONVERTEUR (Pour Modèles LED)

Convertisseur, conforme aux normes ENEC. Longue vie. Perte de puissance faible avec courant constant.

LED (Pour Modèles LED)

Modules LED – Durée de vie 50.000 heures avec LED de marque LUMILEDS / OSRAM / SEOUL.

LED'li Tip / LED Type / Type LED

Renk Geri Verim Indexi / Color Rendering Index / Indice de Rendu des Couleurs: (CRI): Ra>80

Kod Code	Güç Power Puissance (W)	LED Tipi LED Type Type De LED	LED Modül LED Module Module LED	Işık Akısı Lum. Flux Flux Lum. (lm)	Renk Sıcaklığı Color Temperature Température De Couleur (K)	Ölçüler Dimensions (mm) a l h			Ağırlık Weight Poids (kg)	Ambalaj Adedi Packing Quantity Colisage	Adet/20" Konteyner Pcs./20" Container Pcs./20" Conteneur
PL9U11L15C	1x6,5	3535 SMD	PCB	850	3000 / 4000 / 6500	93	328	63	0,7	2	12250
PL9U12L15C	2x6,5	3535 SMD	PCB	1700	3000 / 4000 / 6500	93	609	63	1,8	2	6690
PL9U13L15C	3x6,5	3535 SMD	PCB	2550	3000 / 4000 / 6500	93	890	63	2,3	2	4600
PL9U14L15C	4x6,5	3535 SMD	PCB	3400	3000 / 4000 / 6500	93	1170	63	2,8	2	3510
PL9U15L15C	5x6,5	3535 SMD	PCB	4250	3000 / 4000 / 6500	93	1450	63	3,3	2	2840

T5 Floresanlı Tip / T5 Fluorescent Type / Type T5 Fluorescent

Kod Code	Güç Power Puissance (W)	Ampul Tipi Lamp Type Type De Lampe	Duy Tipi Socket Type Type De Douille	Işık Akısı Lum. Flux Flux Lum. (lm)	Akım Current Courant (A)	Ölçüler Dimensions (mm) a l h			Ağırlık Weight Poids (kg)	Ambalaj Adedi Packing Quantity Colisage	Adet/20" Konteyner Pcs./20" Container Pcs./20" Conteneur
P59U114C	1x14	T16(T5)	G5	1200	0.08	93	625	63	1,4	2	6520
P59U124C	1x24	T16(T5)	G5	1750	0.12	93	625	63	1,4	2	6520
P59U121C	1x21	T16(T5)	G5	1900	0.11	93	925	63	1,9	2	4430
P59U128C	1x28	T16(T5)	G5	2600	0.14	93	1225	63	2,4	2	3350
P59U154C	1x54	T16(T5)	G5	4450	0.26	93	1225	63	2,4	2	3350
P59U135C	1x35	T16(T5)	G5	3300	0.17	93	1525	63	2,9	2	2700
P59U149C	1x49	T16(T5)	G5	4300	0.24	93	1525	63	2,9	2	2700
P59U180C	1x80	T16(T5)	G5	6150	0.38	93	1525	63	2,9	2	2700

V / Hz 220 - 240 / 50 - 60

Opsiyonlar	Options	Options
DIM edilebilir elektronik balast yada konvertör.	Dimmable electronic ballast or convertor.	Ballast électronique dimmable ou converteur.
Acil durum kiti.	Emergency kit.	Kit d'urgence.
Priz	Socket	Prise

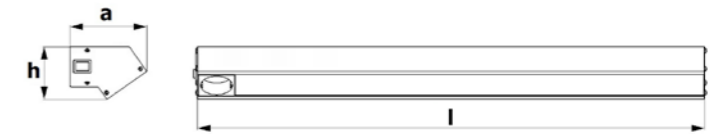





V TİPİ / V TYPE



LED

Sıva Üstü Buzlu Difüzörlü
Aydınlatma Armatürleri

Surface Mounted Lighting Fixtures
With Frosted Diffuser
Luminaires Apparents
Avec Diffuseur Givré

UYGULAMA ALANLARI

Alışveriş Merkezleri
Marketler
Ofisler
Toplantı odaları
Mağazalar
Hastaneler
Okullar
Koridorlar

APPLICATION AREAS

Shopping Malls
Supermarkets
Offices
Meeting rooms
Stores
Hospitals
Schools
Corridors

DOMAINES D'UTILISATION

Centres Commerciaux
Supermarchés
Bureaux
Salles de Réunion
Magasins
Hopitaux
Ecoles
Couloirs

GÖVDE

Elektrostatik toz boyalı sac.

DİFÜZÖR

UV korumalı difüzör

KONVERTÖR

ENEC standartlarına uygun, uzun ömürlü sabit akımlı konvertör.

LED

50.000 saat ömürlü LUMILEDS / OSRAM / SEOUL marka LED'li LED modüller.

BODY

Electrostatic powder coated sheetmetal.

DIFFUSER

UV stabilized diffuser.

CONVERTER

Long life, low power loss converter with constant current. Compatible with ENEC standards.

LED

LED modules with 50,000 hours lifetime LUMILEDS / OSRAM / SEOUL brand LEDs.

CORPS

Feuille de métal peinte électrostatiquement.

DIFFUSEUR

Diffuseur en anti UV.

CONVERTEUR

Convertisseur, conforme aux normes ENEC. Longue vie. Perte de puissance faible avec courant constant.

LED

Modules LED – Durée de vie 50.000 heures avec LED de marque LUMILEDS / OSRAM / SEOUL.

LED'li Tip / LED Type / Type LED

Renk Geri Verim Indexi / Color Rendering Index / Indice de Rendu des Couleurs: (CRI): Ra>80

Kod Code	Güç Power Puissance (W)	LED Tipi LED Type Type De LED	LED Modül LED Module Module LED	Işık Akısı Lum. Flux Flux Lum. (lm)	Renk Sıcaklığı Color Temperature Température De Couleur (K)	Ölçüler Dimensions (mm)			Ağırlık Weight Poids (kg)	Ambalaj Adedi Packing Quantity Colisage	Adet/20" Konteyner Pcs./20" Conteneur
						a	b	h			
PL11U18C	18	3030 SMD	PCB	1600	3000 / 4000 / 6500	345	345	70	2.0	4	4100
PL11U35C	35	3030 SMD	PCB	3200	3000 / 4000 / 6500	610	610	70	5.7	2	1000

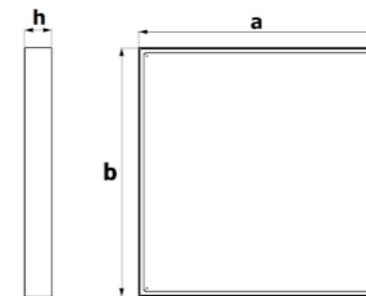

V / Hz 220 - 240 / 50 - 60

Opsiyonlar	Options	Options
DIM edilebilir konvertör.	Dimmable converter.	Convertisseur dimmable.
Acil durum kiti.	Emergency kit.	Kit d'urgence.



 **pamir**[®]
aydınlıkta

STERİL
STERILE
STÉRILE

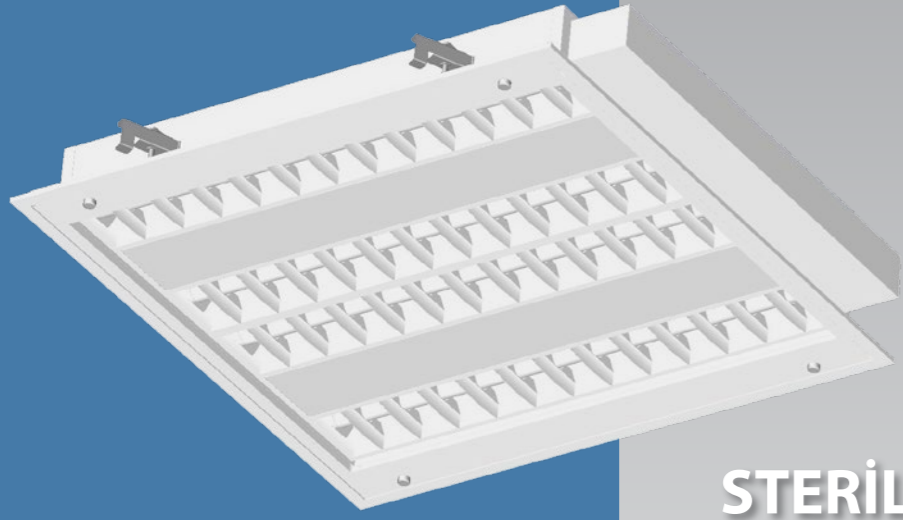

**STERİL
STERILE
STÉRILE**

Tavan Bağlantı Sistemleri
Ceiling Mounting System
Système de Montage au Plafond



T26 (T8)

Sıva Altı Alüminyum Reflektörlü
Aydınlatma Armatürleri

Recessed Lighting Fixtures With
Aluminum Reflector

Luminaires Encastré Avec
Reflecteur en Aluminium

UYGULAMA ALANLARI

Hasta Odaları
Ameliyat Odaları
Muayene Odaları

APPLICATION AREAS

Patient Rooms
Surgery Rooms
Consulting Rooms

DOMAINES D'UTILISATION

Chambres Des Patients
Salles d'Opération
Salles de Consultation

Kod Code	Güç Power Puissance (W)	Ampul Tipi Lamp Type Type De Lampe	Duy Tipi Socket Type Type De Douille	Işık Akısı Lum. Flux Flux Lum. (lm)	Akım Current Courant (A)	Ölçüler Dimensions (mm)					Ağırlık Weight Poids (kg)	Ambalaj Adedi Packing Quantity Colisage	Adet/20" Konteyner Pcs./20" Container Pcs./20" Conteneur
						a1	a2	b1	b2	h			
P812A218C	2x18	T26(T8)	G5	2700	0.18	295	275	595	575	85	4	2	1440
P812A418C	4x18	T26(T8)	G5	5400	0.34	595	575	595	575	85	8	2	820

GÖVDE

Elektrostatik toz boyalı sac.

REFLEKTÖR

%99,9 Safılıkta, ayna yüzeyi parlaklığında ve yüksek yansıtma performansına sahip ışığın verimli bir şekilde dağılımını sağlayan zarif tasarımlı eloksallı alüminyum.

BALAST

ENEC standartlarına uygun, uzun ömürlü sabit ışık akısına sahip, düşük enerji kayıplı (EEI=A2) elektronik balast

CONTA

Elestomer termoplastik.

CAM

4mm temperli cam (kalite belgeli).

BODY

Electrostatic powder coated sheetmetal.

REFLECTOR

Anodized aluminum with %99,9 purity and with mirror like glossy surface having high reflection performance. Elegant design enables the efficient distribution of the light to the targeted area.

BALLAST

Electronic ballast with long life, low power loss EEI = A2 and constant flux. Compatible with ENEC standards.

SEAL

Thermoplastic elastomer.

GLASS

4mm tempered glass (with certificate).

CORPS

Feuille de métal peinte électrostatiquement.

REFLECTEUR

En aluminium anodisé à 99,9% de pureté et avec une surface brillante comme un miroir, assurant un niveau élevé de réflexion. Design élégant. Permet une répartition efficace de la lumière vers l'endroit ciblé.

BALLAST

Ballast électronique, conforme aux normes ENEC. Longue vie. Perte de puissance faible (EEI=A2). Flux de lumière régulier.

JOINT

Elastomère thermoplastique.

VERRE

4 mm verre trempé (avec certificat).

V / Hz 220 - 240 / 50 - 60

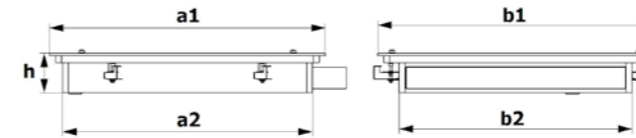

Opsiyonlar	Options	Options
DIM edilebilir elektronik balast.	Dimmable electronic ballast.	Ballast électronique dimmable.
Acil Durum Kiti.	Emergency Kit.	Kit d'urgence.

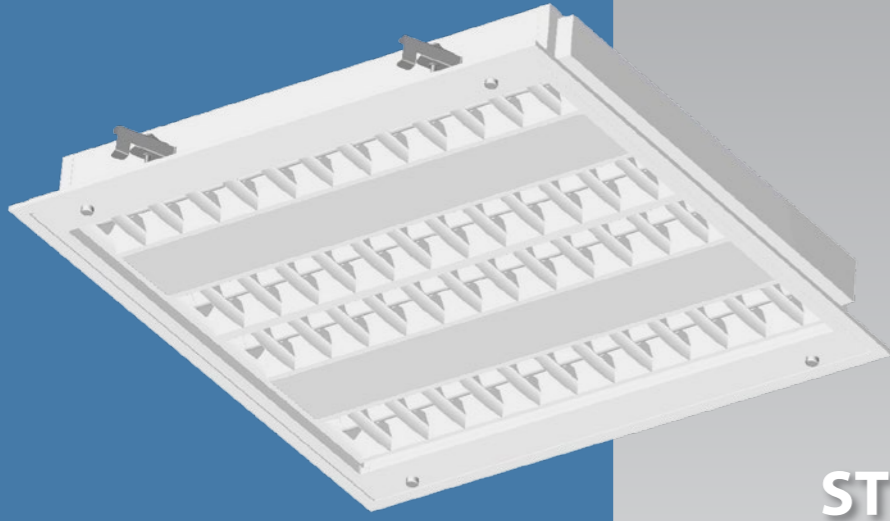

STERİL STERILE STÉRILE

Tavan Bağlantı Sistemleri
Ceiling Mounting System
Système de Montage au Plafond

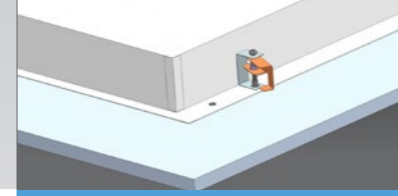

T16 (T5)

Sıva Altı Alüminyum Reflektörlü Aydınlatma Armatürleri

Recessed Lighting Fixtures With
Aluminum Reflector

Luminaire Encastre Avec
Reflecteur en Aluminium

UYGULAMA ALANLARI

Hasta Odaları
Ameliyat Odaları
Muayene Odaları

APPLICATION AREAS

Patient Rooms
Surgery Rooms
Consulting Rooms

DOMAINES D'UTILISATION

Chambres Des Patients
Salles d'Opération
Salles de Consultation

Kod Code	Güç Power Puissance (W)	Ampul Tipi Lamp Type Type De Lampe	Duy Tipi Socket Type Type De Douille	Işık Akısı Lum. Flux Flux Lum. (lm)	Akım Current Courant (A)	Ölçüler Dimensions (mm)					Ağırlık Weight Poids (kg)	Ambalaj Adedi Packing Quantity Colisage	Adet/20" Konteyner Pcs./20" Conteneur
						a1	a2	b1	b2	h			
P512A214C	2x14	T16(T5)	G5	2400	0.14	295	275	595	575	85	4	2	1440
P512A414C	4x14	T16(T5)	G5	4800	0.28	595	575	595	575	85	8	2	820

GÖVDE

Elektrostatik toz boyalı sac.

REFLEKTÖR

%99,9 Safılıkta, ayna yüzeyi parlaklığında ve yüksek yansıtma performansına sahip ışığın verimli bir şekilde dağılımını sağlayan zarif tasarımlı eloksallı kaplamalı alüminyum.

BALAST

ENEC standartlarına uygun, uzun ömürlü sabit ışık akısına sahip, düşük enerji kayıplı (EEI=A2) elektronik balast

CONTA

Elestomer termoplastik.

CAM

4mm temperli cam (kalite belgeli).

BODY

Electrostatic powder coated sheetmetal.

REFLECTOR

Anodized aluminum with %99,9 purity and with mirror like glossy surface having high reflection performance. Elegant design enables the efficient distribution of the light to the targeted area.

BALLAST

Electronic ballast with long life, low power loss EEI = A2 and constant flux. Compatible with ENEC standards.

SEAL

Thermoplastic elastomer.

GLASS

4mm tempered glass (with certificate).

CORPS

Feuille de métal peinte électrostatiquement.

REFLECTEUR

En aluminium anodisé à 99,9% de pureté et avec une surface brillante comme un miroir, assurant un niveau élevé de réflexion. Design élégant. Permet une répartition efficace de la lumière vers l'endroit ciblé.

BALLAST

Ballast électronique, conforme aux normes ENEC. Longue vie. Perte de puissance faible (EEI=A2). Flux de lumière régulier.

JOINT

Elastomère thermoplastique.

VERRE

4 mm verre trempé (avec certificat).

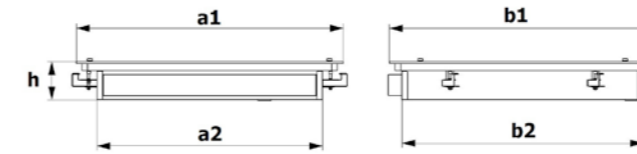

V / Hz 220 - 240 / 50 - 60

Opsiyonlar	Options	Options
DIM edilebilir elektronik balast.	Dimmable electronic ballast.	Ballast électronique dimmable.
Acil Durum Kiti.	Emergency Kit.	Kit d'urgence.

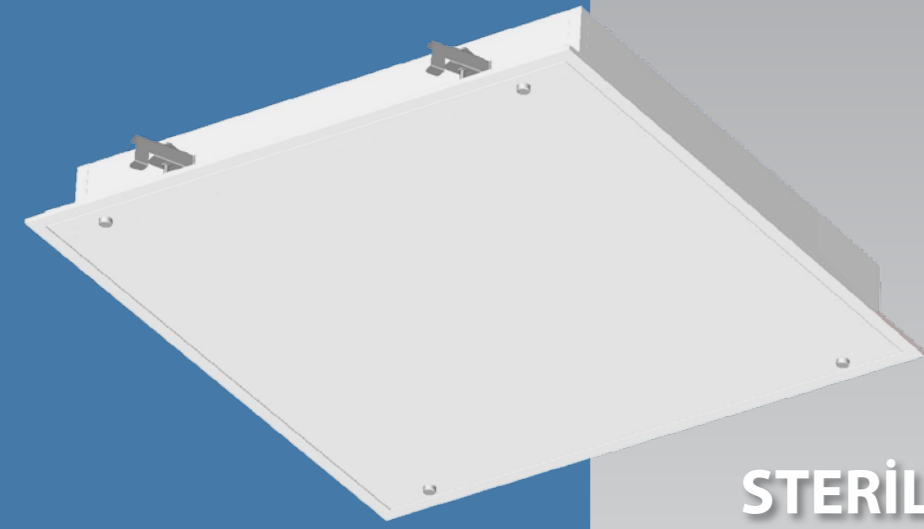

**STERİL
STERILE
STÉRILE**

Tavan Bağlantı Sistemleri
Ceiling Mounting System
Système de Montage au Plafond



LED

Sıva Altı Buzlu Akrilik Difüzörlü
Aydınlatma Armatürleri

Recessed Lighting Fixtures With
Frosted Acrylic Diffuser

Luminaires Encastré Avec
Diffuseur Acrylique Givré

UYGULAMA ALANLARI

Hasta Odaları
Ameliyat Odaları
Muayene Odaları

APPLICATION AREAS

Patient Rooms
Surgery Rooms
Consulting Rooms

DOMAINES D'UTILISATION

Chambres Des Patients
Salles d'Opération
Salles de Consultation

LED'li Tip / LED Type / Type LED

Renk Geri Verim Indexi / Color Rendering Index / Indice de Rendu des Couleurs: (CRI): Ra>80

Kod Code	Güç Power Puissance (W)	LED Tipi LED Type Type De LED	LED Modül LED Module Module LED	Işık Akısı Lum. Flux Flux Lum. (lm)	Renk Sıcaklığı Color Temperature Température De Couleur (K)	Ölçüler Dimensions (mm)					Ağırlık Weight Poids (kg)	Ambalaj Adedi Packing Quantity Colisage	Adet/20" Konteyner Pcs./20" Container Pcs./20" Conteneur
						a1	a2	b1	b2	h			
PL12A12E05C	2x10	5630 SMD	PCB	2360	3000 / 4000 / 6500	295	275	595	575	85	4.0	2	1440
PL12A22E05C	4x10	5630 SMD	PCB	4720	3000 / 4000 / 6500	595	575	595	575	85	8.0	2	820

GÖVDE

Elektrostatik toz boyalı sac.

DİFÜZÖR

UV korumalı akrilik difüzör.

KONVERTÖR

ENEC standartlarına uygun, uzun ömürlü sabit akımlı konvertör.

LED

50.000 saat ömürlü LUMILEDS / OSRAM / SEOUL marka LED'li LED modülleri.

CONTA

Elestomer termoplastik.

CAM

4mm temperli cam (kalite belgeli).

BODY

Electrostatic powder coated sheetmetal.

DIFFUSER

UV stabilized acrylic diffuser.

CONVERTER

Long life, low power loss converter with constant current. Compatible with ENEC standards.

LED

LED modules with 50,000 hours lifetime LUMILEDS / OSRAM / SEOUL brand LEDs.

SEAL

Thermoplastic elastomer.

GLASS

4mm tempered glass (with certificate).

CORPS

Feuille de métal peinte électrostatiquement.

DIFFUSEUR

Diffuseur en acrylique, anti UV.

CONVERTEUR

Convertisseur, conforme aux normes ENEC. Longue vie. Perte de puissance faible avec courant constant.

LED

Modules LED – Durée de vie 50.000 heures avec LED de marque LUMILEDS / OSRAM / SEOUL.

JOINT

Elastomère thermoplastique.

VERRE

4 mm verre trempé (avec certificat).

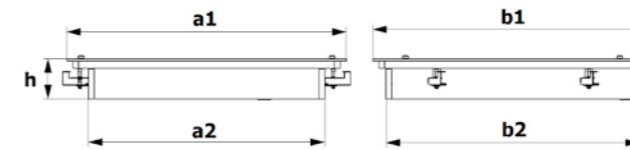

V / Hz 220 - 240 / 50 - 60

Opsiyonlar	Options	Options
DIM edilebilir konvertör.	Dimmable converter.	Convertisseur dimmable.
Acil durum kiti.	Emergency kit.	Kit d'urgence.



 **pamir**[®]
aydınlıkta

SIVA ALTI / RECESSED / ENCASTRE



SIVA ALTI RECESSED ENCASTRE

Tavan Bağlantı Sistemleri
Ceiling Mounting System
Système de Montage au Plafond

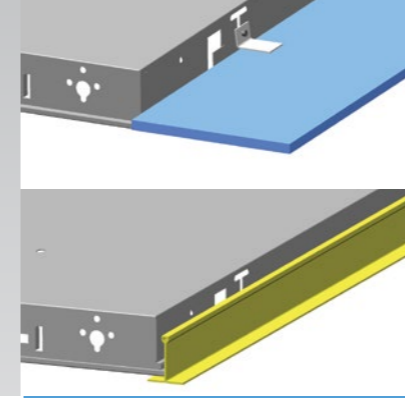

T16 (T5)

2X Alüminyum Reflektörlü Aydınlatma Armatürleri

2X Lighting Fixtures With Aluminum Reflector

Luminaire 2X Avec Reflecteur en Aluminium

UYGULAMA ALANLARI

Ofisler
Toplantı Odaları
Mağazalar
Hastaneler
Okullar
Koridorlar

APPLICATION AREAS

Offices
Meeting rooms
Stores
Hospitals
Schools
Corridors

DOMAINES D'UTILISATION

Bureaux
Salles de Réunion
Magasins
Hopitaux
Ecoles
Coulloirs

Kod Code	Güç Power Puissance (W)	Ampul Tipi Lamp Type Type De Lampe	Duy Tipi Socket Type Type De Douille	Işık Akısı Lum. Flux Flux Lum. (lm)	Akım Current Courant (A)	Ölçüler Dimensions (mm)					Ağırlık Weight Poids (kg)	Ambalaj Adedi Packing Quantity Colisage	Adet/20" Konteyner Pcs./20" Conteneur
						a1	a2	b1	b2	h			
P51A214A	2x14	T16(T5)	G5	2400	0.14	295	275	595	575	36	1.84	4	2520
P51A224A	2x24	T16(T5)	G5	3500	0.23	295	275	595	575	36	1.84	4	2520
P51A228A	2x28	T16(T5)	G5	5200	0.26	295	275	1195	1175	36	3.23	2	1270
P51A254A	2x54	T16(T5)	G5	8900	1.50	295	275	1195	1175	36	3.23	2	1270

V / Hz 220 - 240 / 50 - 60

Opsiyonlar	Options	Options
DIM edilebilir elektronik balast.	Dimmable electronic ballast.	Ballast électronique dimmable.
Acil Durum Kiti.	Emergency Kit.	Kit d'urgence.

GÖVDE

Elektrostatik toz boyalı sac.

REFLEKTÖR

%99,9 Safılıkta, ayna yüzeyi parlaklığında ve yüksek yansıtma performansına sahip ışığın verimli bir şekilde dağılımını sağlayan zarif tasarımlı eloksallı kaplamalı alüminyum.

BALAST

ENEC standartlarına uygun, uzun ömürlü sabit ışık akısına sahip, düşük enerji kayıplı (EEI=A2) elektronik balast

BODY

Electrostatic powder coated sheetmetal.

REFLECTOR

Anodized aluminum with %99,9 purity and with mirror like glossy surface having high reflection performance. Elegant design enables the efficient distribution of the light to the targeted area.

BALLAST

Electronic ballast with long life, low power loss EEI = A2 and constant flux. Compatible with ENEC standards.

CORPS

Feuille de métal peinte électrostatiquement.

REFLECTEUR

En aluminium anodisé à 99,9% de pureté et avec une surface brillante comme un miroir, assurant un niveau élevé de réflexion. Design élégant. Permet une répartition efficace de la lumière vers l'endroit ciblé.

BALLAST

Ballast électronique, conforme aux normes ENEC. Longue vie. Perte de puissance faible (EEI=A2). Flux de lumière régulier.

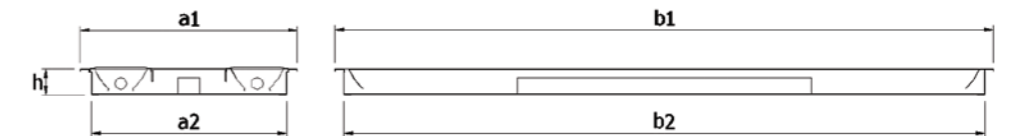



SIVA ALTI RECESSED ENCASTRE

Tavan Bağlantı Sistemleri
Ceiling Mounting System
Système de Montage au Plafond

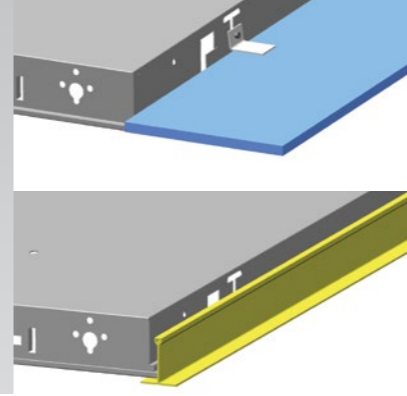

T16 (T5)

2X Buzlu Difüzörlü
Aydınlatma Armatürleri

2X Lighting Fixtures With
Frosted Diffuser

Luminaire 2X Avec
Diffuseur Givré

UYGULAMA ALANLARI

Ofisler
Toplantı Odaları
Mağazalar
Hastaneler
Okullar
Koridorlar

APPLICATION AREAS

Offices
Meeting rooms
Stores
Hospitals
Schools
Corridors

DOMAINES D'UTILISATION

Bureaux
Salles de Réunion
Magasins
Hopitaux
Ecoles
Couloirs

GÖVDE

Elektrostatik toz boyalı sac.

DİFÜZÖR

UV korumalı buzlu difüzör.

BALAST

ENEC standartlarına uygun, uzun ömürlü sabit ışık akısına sahip, düşük enerji kayıplı (EEI=A2) elektronik balast

BODY

Electrostatic powder coated sheetmetal.

DIFFUSER

UV stabilized frosted diffuser.

BALLAST

Electronic ballast with long life, low power loss EEI = A2 and constant flux. Compatible with ENEC standards.

CORPS

Feuille de métal peinte électrostatiquement.

DIFFUSEUR

Diffuseur givré, anti UV.

BALLAST

Ballast électronique, conforme aux normes ENEC. Longue vie. Perte de puissance faible (EEI=A2). Flux de lumière régulier.

Kod Code	Güç Power Puissance (W)	Ampul Tipi Lamp Type Type De Lampe	Duy Tipi Socket Type Type De Douille	Işık Akısı Lum. Flux Flux Lum. (lm)	Akım Current Courant (A)	Ölçüler Dimensions (mm)					Ağırlık Weight Poids (kg)	Ambalaj Adedi Packing Quantity Colisage	Adet/20" Konteyner Pcs./20" Container Pcs./20" Conteneur
						a1	a2	b1	b2	h			
P51A214C	2x14	T16(T5)	G5	2400	0.14	295	275	595	575	36	2.2	4	2520
P51A224C	2x24	T16(T5)	G5	3500	0.23	295	275	595	575	36	2.2	4	2520
P51A228C	2x28	T16(T5)	G5	5200	0.26	295	275	1195	1175	36	3.8	2	1270
P51A254C	2x54	T16(T5)	G5	8900	0.50	295	275	1195	1175	36	3.8	2	1270

V / Hz 220 - 240 / 50 - 60

Opsiyonlar	Options	Options
DIM edilebilir elektronik balast.	Dimmable electronic ballast.	Ballast électronique dimmable.
Acil Durum Kiti.	Emergency Kit.	Kit d'urgence.

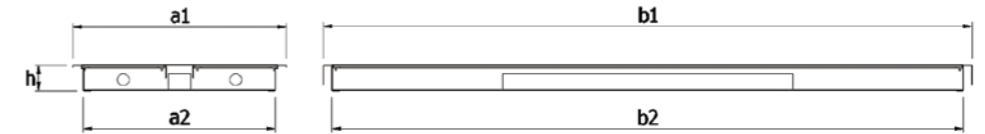



SIVA ALTI RECESSED ENCASTRE

Tavan Bağlantı Sistemleri
Ceiling Mounting System
Système de Montage au Plafond

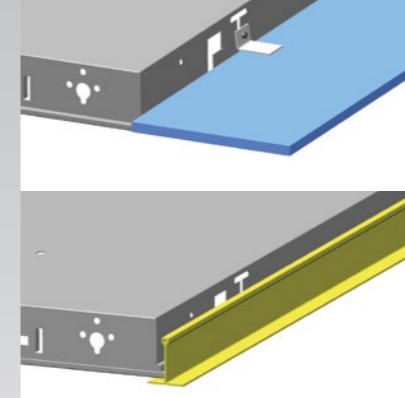

T16 (T5)

4X Alüminyum Reflektörlü Aydınlatma Armatürleri

4X Lighting Fixtures With Aluminum Reflector

Luminaire 4X Avec Reflecteur en Aluminium

UYGULAMA ALANLARI

Ofisler
Toplantı Odaları
Mağazalar
Hastaneler
Okullar
Koridorlar

APPLICATION AREAS

Offices
Meeting rooms
Stores
Hospitals
Schools
Corridors

DOMAINES D'UTILISATION

Bureaux
Salles de Réunion
Magasins
Hopitaux
Ecoles
Coulloirs

GÖVDE

Elektrostatik toz boyalı sac.

REFLEKTÖR

%99,9 Saflıkta, ayna yüzeyi parlaklığında ve yüksek yansıtma performansına sahip ışığın verimli bir şekilde dağılımını sağlayan zarif tasarımı eloksallı alüminyum.

BALAST

ENEC standartlarına uygun, uzun ömürlü sabit ışık akısına sahip, düşük enerji kayıplı (EEI=A2) elektronik balast

BODY

Electrostatic powder coated sheetmetal.

REFLECTOR

Anodized aluminum with %99,9 purity and with mirror like glossy surface having high reflection performance. Elegant design enables the efficient distribution of the light to the targeted area.

BALLAST

Electronic ballast with long life, low power loss EEI = A2 and constant flux. Compatible with ENEC standards.

CORPS

Feuille de métal peinte électrostatiquement.

REFLECTEUR

En aluminium anodisé à 99,9% de pureté et avec une surface brillante comme un miroir, assurant un niveau élevé de réflexion. Design élégant. Permet une répartition efficace de la lumière vers l'endroit ciblé.

BALLAST

Ballast électronique, conforme aux normes ENEC. Longue vie. Perte de puissance faible (EEI=A2). Flux de lumière régulier.

Kod Code	Güç Power Puissance (W)	Ampul Tipi Lamp Type Type De Lampe	Duy Tipi Socket Type Type De Douille	Işık Akısı Lum. Flux Flux Lum. (lm)	Akım Current Courant (A)	Ölçüler Dimensions (mm)					Ağırlık Weight Poids (kg)	Ambalaj Adedi Packing Quantity Colisage	Adet/20" Konteyner Pcs./20" Container Pcs./20" Conteneur
						a1	a2	b1	b2	h			
P51A314A	3x14	T16(T5)	G5	3600	0.20	595	575	595	575	36	3.20	4	1460
P51A414A	4x14	T16(T5)	G5	4800	0.28	595	575	595	575	36	3.31	4	1460
P51A424A	4x24	T16(T5)	G5	7000	0.46	595	575	595	575	36	3.31	4	1460
P51A428A	4x28	T16(T5)	G5	10400	0.52	595	575	1195	1175	36	6.59	2	690
P51A454A	4x54	T16(T5)	G5	17800	1.00	595	575	1195	1175	36	6.59	2	690

V / Hz 220 - 240 / 50 - 60

Opsiyonlar	Options	Options
DIM edilebilir elektronik balast. Acil Durum Kiti.	Dimmable electronic ballast. Emergency Kit.	Ballast électronique dimmable. Kit d'urgence.

P51A414A

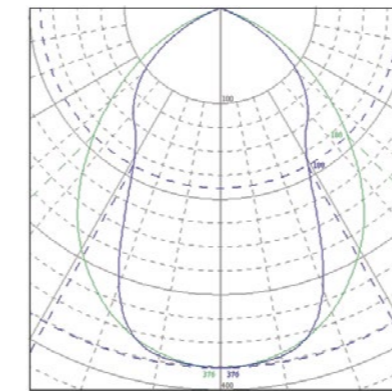

CO - C180
C90 - C270

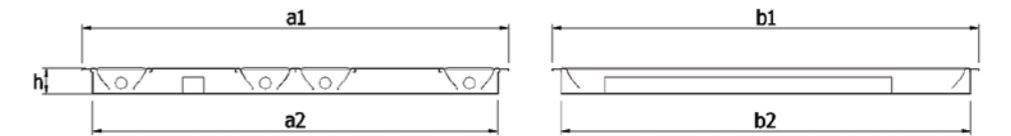



SIVA ALTI RECESSED ENCASTRE

Tavan Bağlantı Sistemleri
Ceiling Mounting System
Système de Montage au Plafond

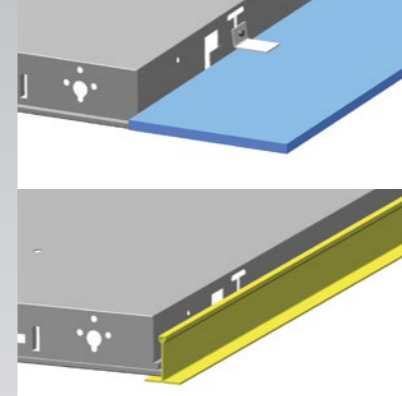

T16 (T5)

4X Buzlu Difüzörlü
Aydınlatma Armatürleri

4X Lighting Fixtures With
Frosted Diffuser

Luminaire 4X Avec
Diffuseur Givré

UYGULAMA ALANLARI

Ofisler
Toplantı Odaları
Mağazalar
Hastaneler
Okullar
Koridorlar

APPLICATION AREAS

Offices
Meeting rooms
Stores
Hospitals
Schools
Corridors

DOMAINES D'UTILISATION

Bureaux
Salles de Réunion
Magasins
Hopitaux
Ecoles
Couloirs

GÖVDE

Elektrostatik toz boyalı sac.

DİFÜZÖR

UV korumalı buzlu difüzör.

BALAST

ENEC standartlarına uygun, uzun ömürlü sabit ışık akısına sahip, düşük enerji kayıplı (EEI=A2) elektronik balast

BODY

Electrostatic powder coated sheetmetal.

DIFFUSER

UV stabilized frosted diffuser.

BALLAST

Electronic ballast with long life, low power loss EEI = A2 and constant flux. Compatible with ENEC standards.

CORPS

Feuille de métal peinte électrostatiquement.

DIFFUSEUR

Diffuseur givré, anti UV.

BALLAST

Ballast électronique, conforme aux normes ENEC. Longue vie. Perte de puissance faible (EEI=A2). Flux de lumière régulier.

Kod Code	Güç Power Puissance (W)	Ampul Tipi Lamp Type Type De Lampe	Duy Tipi Socket Type Type De Douille	Işık Akısı Lum. Flux Flux Lum. (lm)	Akım Current Courant (A)	Ölçüler Dimensions (mm)					Ağırlık Weight Poids (kg)	Ambalaj Adedi Packing Quantity Colisage	Adet/20" Konteyner Pcs./20" Container
						a1	a2	b1	b2	h			
P51A414C	4x14	T16(T5)	G5	4800	0.28	595	575	595	575	36	3.6	4	1460
P51A424C	4x24	T16(T5)	G5	7000	0.44	595	575	595	575	36	3.6	4	1460
P51A428C	4x28	T16(T5)	G5	10400	0.52	595	575	1195	1175	36	7.9	2	690
P51A454C	4x54	T16(T5)	G5	17800	1.00	595	575	1195	1175	36	7.9	2	690

V / Hz 220 - 240 / 50 - 60

Opsiyonlar	Options	Options
DIM edilebilir elektronik balast. Acil Durum Kiti.	Dimmable electronic ballast. Emergency Kit.	Ballast électronique dimmable. Kit d'urgence.

CO - C180
P51A414C C90 - C270

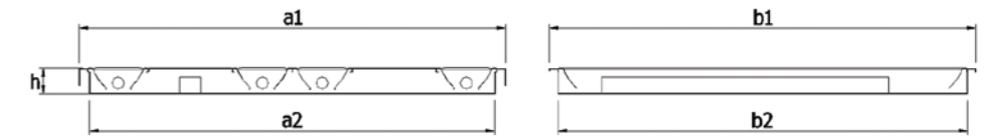
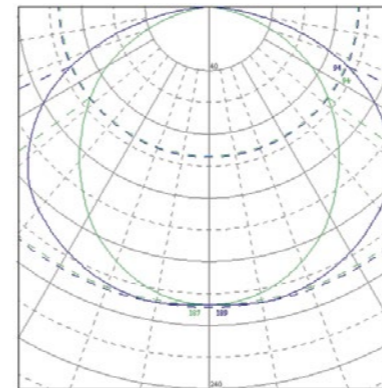

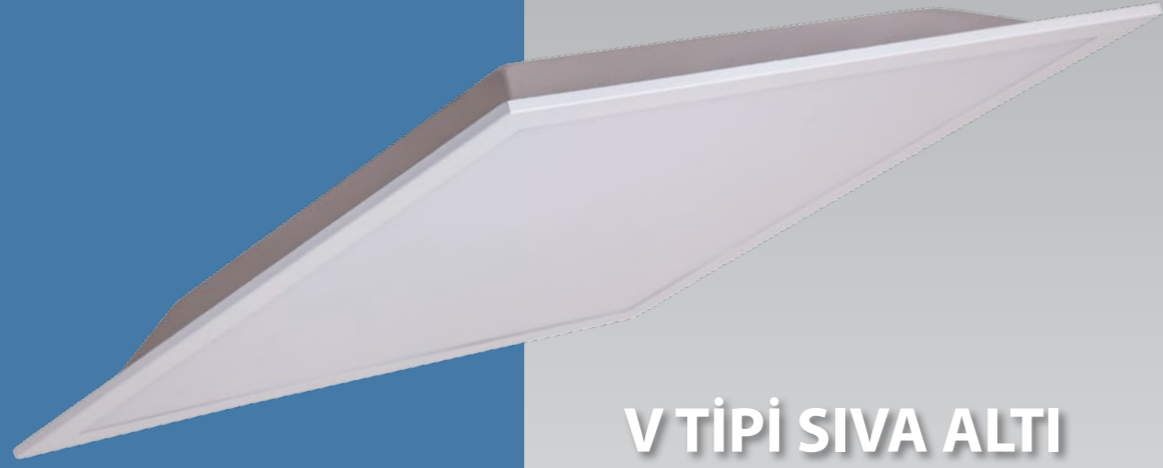

V TİPİ SIVA ALTI V TYPE RECESSED ENCASTRE V TYPE

Tavan Bağlantı Sistemleri
Ceiling Mounting System
Système de Montage au Plafond

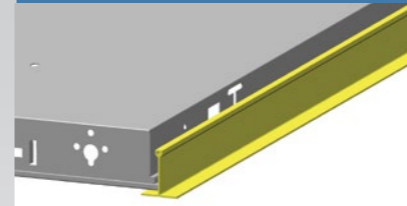

LED

Buzlu Difüzörlü Aydınlatma Armatürleri

Lighting Fixtures With Frosted Diffuser

Luminaires Avec Diffuseur Givré

UYGULAMA ALANLARI

Alışveriş Merkezleri
Marketler
Ofisler
Toplantı odaları
Mağazalar
Hastaneler
Okullar
Koridorlar

APPLICATION AREAS

Shopping Malls
Supermarkets
Offices
Meeting rooms
Stores
Hospitals
Schools
Corridors

DOMAINES D'UTILISATION

Centres Commerciaux
Supermarchés
Bureaux
Salles de Réunion
Magasins
Hopitaux
Ecoles
Coulloirs

GÖVDE

Elektrostatik toz boyalı sac.

DİFÜZÖR

UV korumalı difüzör

KONVERTÖR

ENEC standartlarına uygun, uzun ömürlü sabit akımlı konvertör.

LED

50.000 saat ömürlü LUMILEDS / OSRAM / SEOUL marka LED'li LED modüller.

BODY

Electrostatic powder coated sheetmetal.

DIFFUSER

UV stabilized diffuser.

CONVERTER

Long life, low power loss converter with constant current. Compatible with ENEC standards.

LED

LED modules with 50,000 hours lifetime LUMILEDS / OSRAM / SEOUL brand LEDs.

CORPS

Feuille de métal peinte électrostatiquement.

DIFFUSEUR

Diffuseur en anti UV.

CONVERTEUR

Convertisseur, conforme aux normes ENEC. Longue vie. Perte de puissance faible avec courant constant.

LED

Modules LED – Durée de vie 50.000 heures avec LED de marque LUMILEDS / OSRAM / SEOUL.

LED'li Tip / LED Type / Type LED

Renk Geri Verim Indexi / Color Rendering Index / Indice de Rendu des Couleurs: (CRI): Ra>80

Kod Code	Güç Power Puissance (W)	LED Tipi LED Type Type De LED	LED Modül LED Module Module LED	Işık Akısı Lum. Flux Flux Lum. (lm)	Renk Sıcaklığı Color Temperature Température De Couleur (K)	Ölçüler Dimensions (mm) a b h			Ağırlık Weight Poids (kg)	Ambalaj Adedi Packing Quantity Colisage	Adet/20" Konteyner Pcs./20" Container Pcs./20" Conteneur
PL11A18C	18	3030 SMD	PCB	1600	3000 / 4000 / 6500	295	295	50	0.9	4	4100
PL11A35C	35	3030 SMD	PCB	3200	3000 / 4000 / 6500	595	595	65	2.5	2	1000

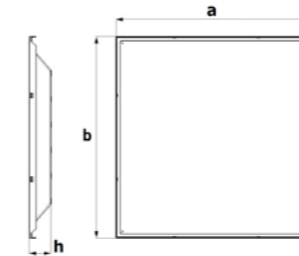

V / Hz 220 - 240 / 50 - 60

Opsiyonlar	Options	Options
Alçıpan yayı.	Gypsum board spring.	Panneaux de gypse ressort.
DİM edilebilir konvertör.	Dimmable converter.	Convertisseur dimmable.
Acil durum kiti.	Emergency kit.	Kit d'urgence.



SIVA ALTI RECESSED ENCASTRE

Tavan Bağlantı Sistemleri
Ceiling Mounting System
Système de Montage au Plafond

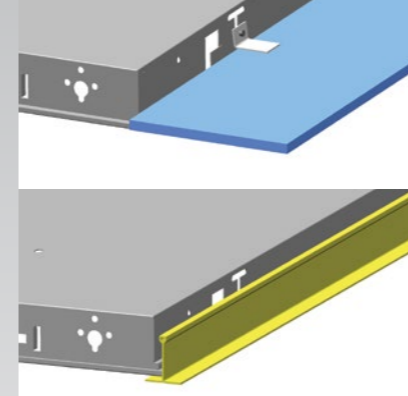

LED / T16 (T5)

Buzlu Difüzörlü
Aydınlatma Armatürleri

Lighting Fixtures With
Frosted Diffuser

Luminaire Avec
Diffuseur Givré

UYGULAMA ALANLARI

Ofisler
Toplantı Odaları
Mağazalar
Hastaneler
Okullar
Koridorlar

APPLICATION AREAS

Offices
Meeting rooms
Stores
Hospitals
Schools
Corridors

DOMAINES D'UTILISATION

Bureaux
Salles de Réunion
Magasins
Hopitaux
Ecoles
Coulloirs

GÖVDE

Elektrostatik toz boyalı sac.

DİFÜZÖR

UV korumalı buzlu difüzör.

BALAST (T5 Modeller İçin)

ENEC standartlarına uygun, uzun ömürlü sabit ışık akısına sahip, düşük enerji kayıplı (EEI=A2) elektronik balast.

KONVERTÖR (LED'li Modeller İçin)

ENEC standartlarına uygun, uzun ömürlü sabit akımlı konvertör.

LED (LED'li Modeller İçin)

50.000 saat ömürlü LUMILEDS / OSRAM / SEOUL marka LED'li LED modülleri.

BODY

Electrostatic powder coated sheetmetal.

DIFFUSEUR

UV stabilized frosted diffuser.

BALLAST (For T5 Models)

Electronic ballast with long life, low power loss EEI = A2 and constant flux. Compatible with ENEC standards.

CONVERTER (For LED Models)

Long life, low power loss converter with constant current. Compatible with ENEC standards.

LED (For LED Models)

LED modules with 50,000 hours lifetime LUMILEDS / OSRAM / SEOUL brand LEDs.

CORPS

Feuille de métal peinte électrostatiquement.

DIFFUSEUR

Diffuseur givré, anti UV.

BALLAST (Pour T5 Modèles)

Ballast électronique, conforme aux normes ENEC. Longue vie. Perte de puissance faible (EEI = A2). Flux de lumière régulier.

CONVERTEUR (Pour Modèles LED)

Convertisseur, conforme aux normes ENEC. Longue vie. Perte de puissance faible avec courant constant.

LED (Pour Modèles LED)

Modules LED – Durée de vie 50.000 heures avec LED de marque LUMILEDS / OSRAM / SEOUL.

Opsiyonlar	Options	Options
DİM edilebilir elektronik balast ya da konvertör.	Dimmable electronic ballast or converter.	Ballast électronique dimmable ou convertisseur.
Acil durum kit.	Emergency kit.	Kit d'urgence.

V / Hz 220 - 240 / 50 - 60

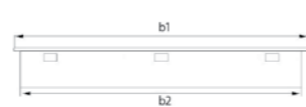

LED'li Tip / LED Type / Type LED

Renk Geri Verim Indexi / Color Rendering Index / Indice de Rendu des Couleurs: (CRI): Ra>80

Kod Code	Güç Power Puissance (W)	LED Tipi LED Type Type De LED	LED Modül LED Module Module LED	Işık Akısı Lum. Flux Flux Lum. (lm)	Renk Sıcaklığı Color Temperature Température De Couleur (K)	Ölçüler Dimensions (mm)					Ağırlık Weight Poids (kg)	Ambalaj Adedi Packing Quantity Colisage	Adet/20" Konteyner Pcs./20" Conteneur
						a1	a2	b1	b2	h			
PL1A11E05D	1x10,0	5630 SMD	PCB	1180	3000 / 4000 / 6500	295	272	295	272	81	1,5	8	2880
PL1A11Q15D	1x12,3	5630 SMD	PCB	1450	3000 / 4000 / 6500	295	272	295	272	81	1,5	8	2880
PL1A11Q25D	1x24,6	5630 SMD	PCB	2700	3000 / 4000 / 6500	295	272	295	272	81	1,5	8	2880
PL1A12E05D	2x10,0	5630 SMD	PCB	2360	3000 / 4000 / 6500	295	272	595	572	81	2,5	4	1440
PL1A12Q15D	2x12,3	5630 SMD	PCB	2900	3000 / 4000 / 6500	295	272	595	572	81	2,5	4	1440
PL1A12Q25D	2x24,6	5630 SMD	PCB	5400	3000 / 4000 / 6500	295	272	595	572	81	2,5	4	1440
PL1A22E05D	4x10,0	5630 SMD	PCB	4720	3000 / 4000 / 6500	595	572	595	572	81	4,1	2	820
PL1A22Q15D	4x12,3	5630 SMD	PCB	5800	3000 / 4000 / 6500	595	572	595	572	81	4,1	2	820
PL1A22Q25D	4x24,6	5630 SMD	PCB	10800	3000 / 4000 / 6500	595	572	595	572	81	4,1	2	820
PL1A23E05D	6x10,0	5630 SMD	PCB	7080	3000 / 4000 / 6500	595	572	895	872	81	5,5	2	540
PL1A23Q15D	6x12,3	5630 SMD	PCB	8700	3000 / 4000 / 6500	595	572	895	872	81	5,5	2	540
PL1A23Q25D	6x24,6	5630 SMD	PCB	16200	3000 / 4000 / 6500	595	572	895	872	81	5,5	2	540

Floresanlı Tip / Fluorescent Type / Type Fluorescent

Kod Code	Güç Power Puissance (W)	Ampul Tipi Lamp Type Type De Lampe	Duy Tipi Socket Type Type De Douille	Işık Akısı Lum. Flux Flux Lum. (lm)	Akım Current Courant (A)	Ölçüler Dimensions (mm)					Ağırlık Weight Poids (kg)	Ambalaj Adedi Packing Quantity Colisage	Adet/20" Konteyner Pcs./20" Conteneur
						a1	a2	b1	b2	h			
PE1A2D	2x13-26	Economic	E27	800-1600	0,11-0,23	295	272	295	272	81	1,1	8	3360
PKC1A218D	2x18	PLC	G24	2400	0,16	295	272	295	272	81	1,3	8	3360
PKC1A226D	2x26	PLC	G24	3500	0,24	295	272	295	272	81	1,3	8	3360
P51A214D	2x14	T16(T5)	G5	2400	0,14	295	272	595	572	81	2,5	4	1440
P51A224D	2x24	T16(T5)	G5	3500	0,23	295	272	595	572	81	2,5	4	1440
P51A228D	2x28	T16(T5)	G5	5200	0,26	295	272	1195	1172	81	4,2	4	660
P51A254D	2x54	T16(T5)	G5	8900	0,50	295	272	1195	1172	81	4,2	4	660
P51A414D	4x14	T16(T5)	G5	4800	0,28	595	572	595	572	81	4,0	2	760
P51A424D	4x24	T16(T5)	G5	7000	0,44	595	572	595	572	81	4,0	2	760
P51A428D	4x28	T16(T5)	G5	10400	0,52	595	572	1195	1172	81	8,5	2	360
P51A454D	4x54	T16(T5)	G5	17800	1,00	595	572	1195	1172	81	8,5	2	360



SIVA ALTI RECESSED ENCASTRE

Tavan Bağlantı Sistemleri
Ceiling Mounting System
Système de Montage au Plafond

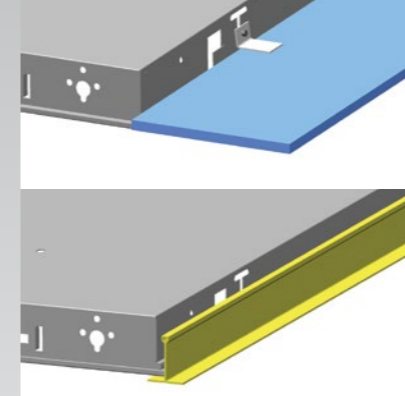

PLL / T16 (T5)

Endirekt Aydınlatma Armatürleri

Indirect Lighting Fixtures

Luminaire Indirects

UYGULAMA ALANLARI

Ofisler
Toplantı Odaları
Mağazalar
Hastaneler
Okullar
Koridorlar

APPLICATION AREAS

Offices
Meeting rooms
Stores
Hospitals
Schools
Corridors

DOMAINES D'UTILISATION

Bureaux
Salles de Réunion
Magasins
Hopitaux
Ecoles
Couloirs

Kod Code	Güç Power Puissance (W)	Ampul Tipi Lamp Type Type De Lampe	Duy Tipi Socket Type Type De Douille	Işık Akısı Lum. Flux Flux Lum. (lm)	Akım Current Courant (A)	Ölçüler Dimensions (mm) a b h	Ağırlık Weight Poids (kg)	Ambalaj Adedi Packing Quantity Colisage	Adet/20" Konteyner Pcs./20" Conteneur
P51A214E	2x14	T16(T5)	G5	2400	0.14	595 595 90	4.2	2	740
P51A224E	2x24	T16(T5)	G5	3500	0.23	595 595 90	4.2	2	740
PKL1A236E	2x36	PLL	2G11	5800	0.32	595 595 90	4.2	2	740
PKL1A255E	2x55	PLL	2G11	9600	0.47	595 595 90	4.3	2	740

V / Hz 220 - 240 / 50 - 60

Opsiyonlar	Options	Options
DIM edilebilir elektronik balast.	Dimmable electronic ballast.	Ballast électronique dimmable.
Acil durum kiti.	Emergency kit.	Kit d'urgence.

GÖVDE

Elektrostatik toz boyalı sac.

BALAST

ENEC standartlarına uygun, uzun ömürlü sabit ışık akısına sahip, düşük enerji kayıplı (EEI=A2) elektronik balast

BODY

Electrostatic powder coated sheetmetal.

BALLAST

Electronic ballast with long life, low power loss EEI = A2 and constant flux. Compatible with ENEC standards.

CORPS

Feuille de métal peinte électrostatiquement.

BALLAST

Ballast électronique, conforme aux normes ENEC. Longue vie. Perte de puissance faible (EEI=A2). Flux de lumière régulier.



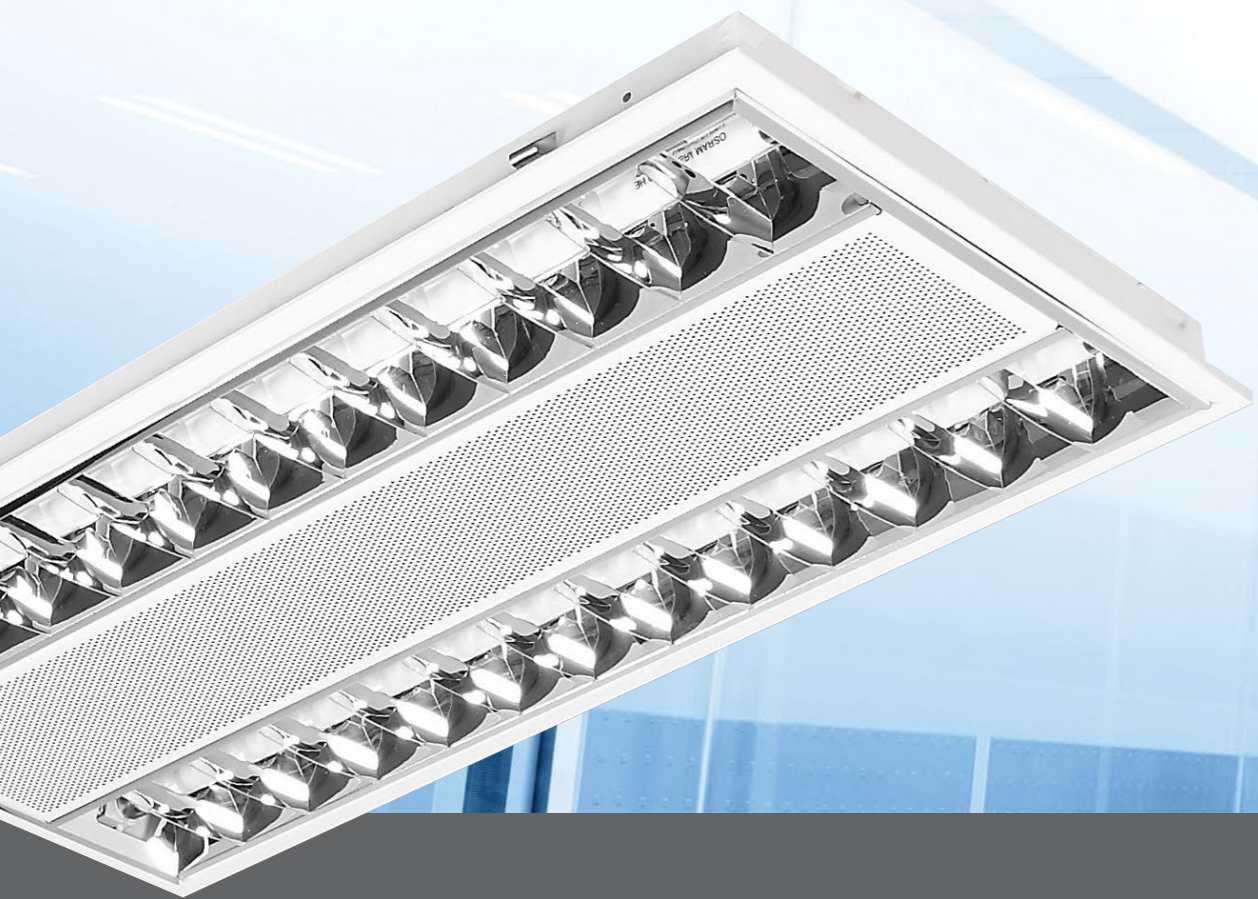

 **pamir**[®]
aydınlatma

CLIP-IN

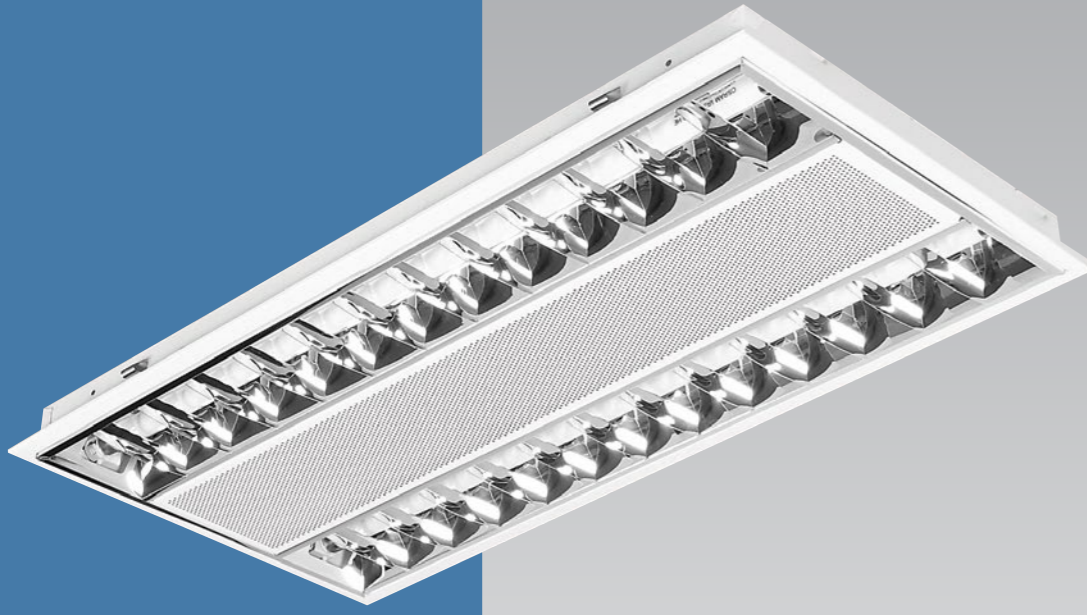

CLIP-IN

T16 (T5)

2X Alüminyum Reflektörlü Aydınlatma Armatürleri

2X Lighting Fixtures With Aluminum Reflector

Luminaire 2X Avec Reflecteur en Aluminium

UYGULAMA ALANLARI

Ofisler
Toplantı Odaları
Mağazalar
Hastaneler
Okullar
Koridorlar

APPLICATION AREAS

Offices
Meeting rooms
Stores
Hospitals
Schools
Corridors

DOMAINES D'UTILISATION

Bureaux
Salles de Réunion
Magasins
Hopitaux
Ecoles
Couloirs

GÖVDE

Elektrostatik toz boyalı sac.

REFLEKTÖR

%99,9 Safılıkta, ayna yüzeyi parlaklığında ve yüksek yansıtma performansına sahip ışığın verimli bir şekilde dağılımını sağlayan zarif tasarımlı eloksallı alüminyum.

BALAST

ENEC standartlarına uygun, uzun ömürlü sabit ışık akısına sahip, düşük enerji kayıplı (EEI=A2) elektronik balast

BODY

Electrostatic powder coated sheetmetal.

REFLECTOR

Anodized aluminum with %99,9 purity and with mirror like glossy surface having high reflection performance. Elegant design enables the efficient distribution of the light to the targeted area.

BALLAST

Electronic ballast with long life, low power loss EEI = A2 and constant flux. Compatible with ENEC standards.

CORPS

Feuille de métal peinte électrostatiquement.

REFLECTEUR

En aluminium anodisé à 99,9% de pureté et avec une surface brillante comme un miroir, assurant un niveau élevé de réflexion. Design élégant. Permet une répartition efficace de la lumière vers l'endroit ciblé.

BALLAST

Ballast électronique, conforme aux normes ENEC. Longue vie. Perte de puissance faible (EEI=A2). Flux de lumière régulier.

Kod Code	Güç Power Puissance (W)	Ampul Tipi Lamp Type Type De Lampe	Duy Tipi Socket Type Type De Douille	Işık Akısı Lum. Flux Flux Lum. (lm)	Akım Current Courant (A)	Ölçüler Dimensions (mm)					Ağırlık Weight Poids (kg)	Ambalaj Adedi Packing Quantity Colisage	Adet/20" Konteyner Pcs./20" Conteneur
						a1	a2	b1	b2	h			
P51C214A	2x14	T16(T5)	G5	2400	0.14	300	275	600	575	36	1.84	4	2520
P51C224A	2x24	T16(T5)	G5	3500	0.23	300	275	600	575	36	1.84	4	2520
P51C228A	2x28	T16(T5)	G5	5200	0.26	300	275	1200	1175	36	3.23	2	1270
P51C254A	2x54	T16(T5)	G5	8900	1.50	300	275	1200	1175	36	3.23	2	1270

V / Hz 220 - 240 / 50 - 60

Opsiyonlar	Options	Options
DIM edilebilir elektronik balast.	Dimmable electronic ballast.	Ballast électronique dimmable.
Acil durum kiti.	Emergency kit.	Kit d'urgence.

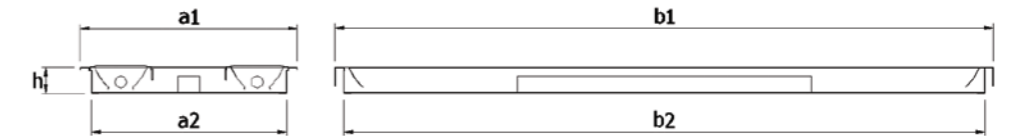



CLIP-IN



T16 (T5)

2X Buzlu Difüzörlü
Aydınlatma Armatürleri

2X Lighting Fixtures With
Frosted Diffuser

Luminaire 2X Avec
Diffuseur Givré

UYGULAMA ALANLARI

Ofisler
Toplantı Odaları
Mağazalar
Hastaneler
Okullar
Koridorlar

APPLICATION AREAS

Offices
Meeting rooms
Stores
Hospitals
Schools
Corridors

DOMAINES D'UTILISATION

Bureaux
Salles de Réunion
Magasins
Hopitaux
Ecoles
Couloirs

GÖVDE

Elektrostatik toz boyalı sac.

DİFÜZÖR

UV korumalı buzlu difüzör.

BALAST

ENEC standartlarına uygun, uzun ömürlü sabit ışık akısına sahip, düşük enerji kayıplı (EEI=A2) elektronik balast.

BODY

Electrostatic powder coated sheetmetal.

DIFFUSER

UV stabilized frosted diffuser.

BALLAST

Electronic ballast with long life, low power loss EEI = A2 and constant flux. Compatible with ENEC standards.

CORPS

Feuille de métal peinte électrostatiquement.

DIFFUSEUR

Diffuseur givré, anti UV.

BALLAST

Ballast électronique, conforme aux normes ENEC. Longue vie. Perte de puissance faible (EEI=A2). Flux de lumière régulier.

Kod Code	Güç Power Puissance (W)	Ampul Tipi Lamp Type Type De Lampe	Duy Tipi Socket Type Type De Douille	Işık Akısı Lum. Flux Flux Lum. (lm)	Akım Current Courant (A)	Ölçüler Dimensions (mm)					Ağırlık Weight Poids (kg)	Ambalaj Adedi Packing Quantity Colisage	Adet/20" Konteyner Pcs./20" Container Pcs./20" Conteneur
						a1	a2	b1	b2	h			
P51C214C	2x14	T16(T5)	G5	2400	0.14	300	275	600	575	36	2.2	4	2520
P51C224C	2x24	T16(T5)	G5	3500	0.23	300	275	600	575	36	2.2	4	2520
P51C228C	2x28	T16(T5)	G5	5200	0.26	300	275	1200	1175	36	3.8	2	1270
P51C254C	2x54	T16(T5)	G5	8900	0.50	300	275	1200	1175	36	3.8	2	1270

V / Hz 220 - 240 / 50 - 60

Opsiyonlar	Options	Options
DIM edilebilir elektronik balast.	Dimmable electronic ballast.	Ballast électronique dimmable.
Acil durum kit.	Emergency kit.	Kit d'urgence.

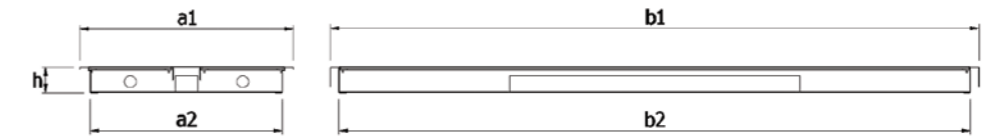



CLIP-IN



T16 (T5)

4X Alüminyum Reflektörlü Aydınlatma Armatürleri

4X Lighting Fixtures With Aluminum Reflector

Luminaire 4X Avec Reflecteur en Aluminium

UYGULAMA ALANLARI

Ofisler
Toplantı Odaları
Mağazalar
Hastaneler
Okullar
Koridorlar

APPLICATION AREAS

Offices
Meeting rooms
Stores
Hospitals
Schools
Corridors

DOMAINES D'UTILISATION

Bureaux
Salles de Réunion
Magasins
Hopitaux
Ecoles
Couloirs

GÖVDE

Elektrostatik toz boyalı sac.

REFLEKTÖR

%99,9 Safılıkta, ayna yüzeyi parlaklığında ve yüksek yansıtma performansına sahip ışığın verimli bir şekilde dağılımını sağlayan zarif tasarımlı eloksallı alüminyum.

BALAST

ENEC standartlarına uygun, uzun ömürlü sabit ışık akısına sahip, düşük enerji kayıplı (EEI=A2) elektronik balast

BODY

Electrostatic powder coated sheetmetal.

REFLECTOR

Anodized aluminum with %99,9 purity and with mirror like glossy surface having high reflection performance. Elegant design enables the efficient distribution of the light to the targeted area.

BALLAST

Electronic ballast with long life, low power loss EEI = A2 and constant flux. Compatible with ENEC standards.

CORPS

Feuille de métal peinte électrostatiquement.

REFLECTEUR

En aluminium anodisé à 99,9% de pureté et avec une surface brillante comme un miroir, assurant un niveau élevé de réflexion. Design élégant. Permet une répartition efficace de la lumière vers l'endroit ciblé.

BALLAST

Ballast électronique, conforme aux normes ENEC. Longue vie. Perte de puissance faible (EEI=A2). Flux de lumière régulier.

Kod Code	Güç Power Puissance (W)	Ampul Tipi Lamp Type Type De Lampe	Duy Tipi Socket Type Type De Douille	Işık Akısı Lum. Flux Flux Lum. (lm)	Akım Current Courant (A)	Ölçüler Dimensions (mm)					Ağırlık Weight Poids (kg)	Ambalaj Adedi Packing Quantity Colisage	Adet/20" Konteyner Pcs./20" Container Pcs./20" Conteneur
						a1	a2	b1	b2	h			
P51C314A	3x14	T16(T5)	G5	3600	0.20	600	575	600	575	36	3.20	4	1460
P51C414A	4x14	T16(T5)	G5	4800	0.28	600	575	600	575	36	3.31	4	1460
P51C424A	4x24	T16(T5)	G5	7000	0.46	600	575	600	575	36	3.31	4	1460
P51C428A	4x28	T16(T5)	G5	10400	0.52	600	575	1200	1175	36	6.59	2	690
P51C454A	4x54	T16(T5)	G5	17800	1.00	600	575	1200	1175	36	6.59	2	690

V / Hz 220 - 240 / 50 - 60

Opsiyonlar	Options	Options
DİM edilebilir elektronik balast.	Dimmable electronic ballast.	Ballast électronique dimmable.
Acil durum kiti.	Emergency kit.	Kit d'urgence.

P51C414A

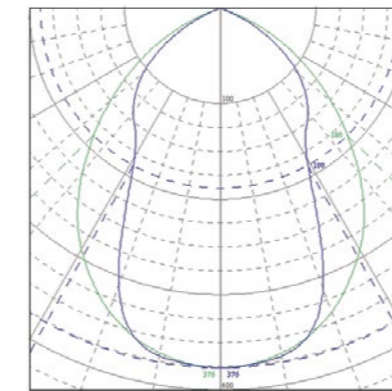

CO - C180
C90 - C270

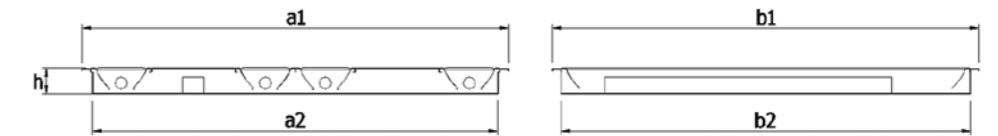



CLIP-IN

T16 (T5)

4X Buzlu Difüzörlü
Aydınlatma Armatürleri

4X Lighting Fixtures With
Frosted Diffuser

Luminaire 4X Avec
Diffuseur Givré

UYGULAMA ALANLARI

Ofisler
Toplantı Odaları
Mağazalar
Hastaneler
Okullar
Koridorlar

APPLICATION AREAS

Offices
Meeting rooms
Stores
Hospitals
Schools
Corridors

DOMAINES D'UTILISATION

Bureaux
Salles de Réunion
Magasins
Hopitaux
Ecoles
Couloirs

GÖVDE

Elektrostatik toz boyalı sac.

DİFÜZÖR

UV korumalı buzlu difüzör.

BALAST

ENEC standartlarına uygun, uzun ömürlü sabit ışık akısına sahip, düşük enerji kayıplı (EEI=A2) elektronik balast

BODY

Electrostatic powder coated sheetmetal.

DIFFUSER

UV stabilized frosted diffuser.

BALLAST

Electronic ballast with long life, low power loss EEI = A2 and constant flux. Compatible with ENEC standards.

CORPS

Feuille de métal peinte électrostatiquement.

DIFFUSEUR

Diffuseur givré, anti UV.

BALLAST

Ballast électronique, conforme aux normes ENEC. Longue vie. Perte de puissance faible (EEI=A2). Flux de lumière régulier.

Kod Code	Güç Power Puissance (W)	Ampul Tipi Lamp Type Type De Lampe	Duy Tipi Socket Type Type De Douille	Işık Akısı Lum. Flux Flux Lum. (lm)	Akım Current Courant (A)	Ölçüler Dimensions (mm)					Ağırlık Weight Poids (kg)	Ambalaj Adedi Packing Quantity Colisage	Adet/20" Konteyner Pcs./20" Container Pcs./20" Conteneur
						a1	a2	b1	b2	h			
P51C414C	4x14	T16(T5)	G5	4800	0.28	600	575	600	575	36	3.6	4	1460
P51C424C	4x24	T16(T5)	G5	7000	0.44	600	575	600	575	36	3.6	4	1460
P51C428C	4x28	T16(T5)	G5	10400	0.52	600	575	1200	1175	36	7.9	2	690
P51C454C	4x54	T16(T5)	G5	17800	1.00	600	575	1200	1175	36	7.9	2	690

V / Hz 220 - 240 / 50 - 60

Opsiyonlar	Options	Options
DIM edilebilir elektronik balast.	Dimmable electronic ballast.	Ballast électronique dimmable.
Acil durum kiti.	Emergency kit.	Kit d'urgence.

P51C414C

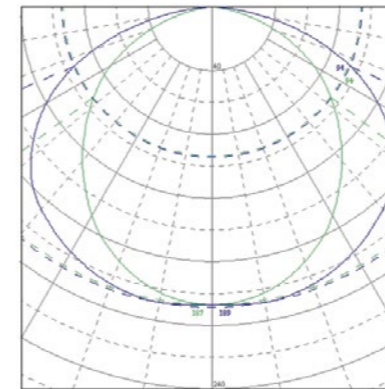

C0 - C180
C90 - C270

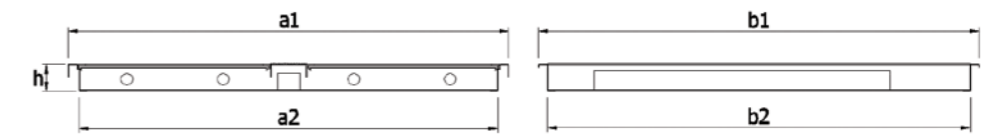

V TİPİ CLIP-IN V TYPE CLIP-IN CLIP-IN V TYPE

LED

Buzlu Difüzörlü Aydınlatma Armatürleri

Lighting Fixtures With Frosted Diffuse

Luminaires Avec Diffuseur Givré

UYGULAMA ALANLARI

Alışveriş Merkezleri
Marketler
Ofisler
Toplantı odaları
Mağazalar
Hastaneler
Okullar
Koridorlar

APPLICATION AREAS

Shopping Malls
Supermarkets
Offices
Meeting rooms
Stores
Hospitals
Schools
Corridors

DOMAINES D'UTILISATION

Centres Commerciaux
Supermarchés
Bureaux
Salles de Réunion
Magasins
Hopitaux
Ecoles
Coulors

GÖVDE

Elektrostatik toz boyalı sac.

DİFÜZÖR

UV korumalı difüzör.

KONVERTÖR

ENEC standartlarına uygun, uzun ömürlü sabit akımlı konvertör.

LED

50.000 saat ömürlü LUMILEDS / OSRAM / SEOUL marka LED'li LED modüller.

BODY

Electrostatic powder coated sheetmetal.

DIFFUSER

UV stabilized diffuser.

CONVERTER

Long life, low power loss converter with constant current. Compatible with ENEC standards.

LED

LED modules with 50,000 hours lifetime LUMILEDS / OSRAM / SEOUL brand LEDs.

CORPS

Feuille de métal peinte électrostatiquement.

DIFFUSEUR

Diffuseur en anti UV.

CONVERTEUR

Convertisseur, conforme aux normes ENEC. Longue vie. Perte de puissance faible avec courant constant.

LED

Modules LED – Durée de vie 50.000 heures avec LED de marque LUMILEDS / OSRAM / SEOUL.

LED'li Tip / LED Type / Type LED

Renk Geri Verim Indexi / Color Rendering Index / Indice de Rendu des Couleurs: (CRI): Ra>80

Kod Code	Güç Power Puissance (W)	LED Tipi LED Type Type De LED	LED Modül LED Module Module LED	Işık Akısı Lum. Flux Flux Lum. (lm)	Renk Sıcaklığı Color Temperature Température De Couleur (K)	Ölçüler Dimensions (mm) a b h			Ağırlık Weight Poids (kg)	Ambalaj Adedi Packing Quantity Colisage	Adet/20" Konteyner Pcs./20" Container Pcs./20" Conteneur
PL11C18C	18	3030 SMD	PCB	1600	3000 / 4000 / 6500	300	300	50	0.9	4	4100
PL11C35C	35	3030 SMD	PCB	3200	3000 / 4000 / 6500	600	600	65	2.5	2	1000

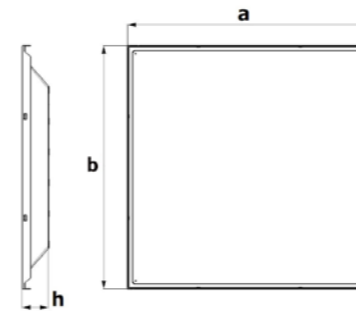

V / Hz 220 - 240 / 50 - 60

Opsiyonlar	Options	Options
DİM edilebilir konvertör.	Dimmable converter.	Convertisseur dimmable.
Acil durum kiti.	Emergency kit.	Kit d'urgence.



CLIP-IN



LED / T16 (T5)

Buzlu Difüzörlü Aydınlatma Armatürleri

Lighting Fixtures With Frosted Diffuser

Luminaire Avec Diffuseur Givré

UYGULAMA ALANLARI

Ofisler
Toplantı Odaları
Mağazalar
Hastaneler
Okullar
Koridorlar

APPLICATION AREAS

Offices
Meeting rooms
Stores
Hospitals
Schools
Corridors

DOMAINES D'UTILISATION

Bureaux
Salles de Réunion
Magasins
Hopitaux
Ecoles
Couloirs

GÖVDE

Elektrostatik toz boyalı sac.

DİFÜZÖR

UV korumalı buzlu difüzör.

BALAST (T5 Modeller İçin)

ENEC standartlarına uygun, uzun ömürlü sabit ışık akısına sahip, düşük enerji kayıplı (EEI=A2) elektronik balast.

KONVERTÖR (LED'li Modeller İçin)

ENEC standartlarına uygun, uzun ömürlü sabit akımlı konvertör.

LED (LED'li Modeller İçin)

50.000 saat ömürlü LUMILEDS / OSRAM / SEOUL marka LED'li LED modülleri.

BODY

Electrostatic powder coated sheetmetal.

DIFFUSER

UV stabilized frosted diffuser.

BALLAST (For T5 Models)

Electronic ballast with long life, low power loss EEI = A2 and constant flux. Compatible with ENEC standards.

CONVERTER (For LED Models)

Long life, low power loss converter with constant current. Compatible with ENEC standards.

LED (For LED Models)

LED modules with 50,000 hours lifetime LUMILEDS / OSRAM / SEOUL brand LEDs.

CORPS

Feuille de métal peinte électrostatiquement.

DIFFUSEUR

Diffuseur givré, anti UV.

BALLAST (Pour T5 Modèles)

Ballast électronique, conforme aux normes ENEC. Longue vie. Perte de puissance faible (EEI = A2). Flux de lumière régulier.

CONVERTEUR (Pour Modèles LED)

Convertisseur, conforme aux normes ENEC. Longue vie. Perte de puissance faible avec courant constant.

LED (Pour Modèles LED)

Modules LED - Durée de vie 50.000 heures avec LED de marque LUMILEDS / OSRAM / SEOUL.



V / Hz 220 - 240 / 50 - 60

LED'li Tip / LED Type / Type LED

Renk Geri Verim Indexi / Color Rendering Index / Indice de Rendu des Couleurs: (CRI): Ra>80

Kod Code	Güç Power Puissance (W)	LED Tipi LED Type Type De LED	LED Modül LED Module Module LED	Işık Akısı Lum. Flux Flux Lum. (lm)	Renk Sıcaklığı Color Temperature Température De Couleur (K)	Ölçüler Dimensions (mm)					Ağırlık Weight Poids (kg)	Ambalaj Adedi Packing Quantity Colisage	Adet/20" Konteyner Pcs./20" Container
						a1	a2	b1	b2	h			
PL1C11E05D	1x10,0	5630 SMD	PCB	1180	3000 / 4000 / 6500	300	272	300	272	81	1.5	8	2880
PL1C11Q15D	1x12,3	5630 SMD	PCB	1450	3000 / 4000 / 6500	300	272	300	272	81	1.5	8	2880
PL1C11Q25D	1x24,6	5630 SMD	PCB	2700	3000 / 4000 / 6500	300	272	300	272	81	1.5	8	2880
PL1C12E05D	2x10,0	5630 SMD	PCB	2360	3000 / 4000 / 6500	300	272	600	572	81	2.5	4	1440
PL1C12Q15D	2x12,3	5630 SMD	PCB	2900	3000 / 4000 / 6500	300	272	600	572	81	2.5	4	1440
PL1C12Q25D	2x24,6	5630 SMD	PCB	5400	3000 / 4000 / 6500	300	272	600	572	81	2.5	4	1440
PL1C22E05D	4x10,0	5630 SMD	PCB	4720	3000 / 4000 / 6500	600	572	600	572	81	4.1	2	820
PL1C22Q15D	4x12,3	5630 SMD	PCB	5800	3000 / 4000 / 6500	600	572	600	572	81	4.1	2	820
PL1C22Q25D	4x24,6	5630 SMD	PCB	10800	3000 / 4000 / 6500	600	572	600	572	81	4.1	2	820
PL1C23E05D	6x10,0	5630 SMD	PCB	7080	3000 / 4000 / 6500	600	572	900	872	81	5.5	2	540
PL1C23Q15D	6x12,3	5630 SMD	PCB	8700	3000 / 4000 / 6500	600	572	900	872	81	5.5	2	540
PL1C23Q25D	6x24,6	5630 SMD	PCB	16200	3000 / 4000 / 6500	600	572	900	872	81	5.5	2	540

Floresanlı Tip / Fluorescent Type / Type Fluorescent

Kod Code	Güç Power Puissance (W)	Ampul Tipi Lamp Type Type De Lampe	Duy Tipi Socket Type Type De Douille	Işık Akısı Lum. Flux Flux Lum. (lm)	Akım Current Courant (A)	Ölçüler Dimensions (mm)					Ağırlık Weight Poids (kg)	Ambalaj Adedi Packing Quantity Colisage	Adet/20" Konteyner Pcs./20" Container
						a1	a2	b1	b2	h			
PE1C2D	2x13-26	Economic	E27	800-1600	0,11-0,23	300	272	300	272	81	1,1	4	3360
PKC1C218D	2x18	PLC	G24	2400	0,16	300	272	300	272	81	1,3	4	3360
PKC1C226D	2x26	PLC	G24	3500	0,24	300	272	300	272	81	1,3	4	3360
P51C214D	2x14	T16(T5)	G5	2400	0,14	300	272	600	572	81	2,5	4	1440
P51C224D	2x24	T16(T5)	G5	3500	0,23	300	272	600	572	81	2,5	4	1440
P51C228D	2x28	T16(T5)	G5	5200	0,26	300	272	1200	1172	81	4,2	4	660
P51C254D	2x54	T16(T5)	G5	8900	0,50	300	272	1200	1172	81	4,2	4	660
P51C414D	4x14	T16(T5)	G5	4800	0,28	600	572	600	572	81	4,0	2	760
P51C424D	4x24	T16(T5)	G5	7000	0,44	600	572	600	572	81	4,0	2	760
P51C428D	4x28	T16(T5)	G5	10400	0,52	600	572	1200	1172	81	8,5	2	360
P51C454D	4x54	T16(T5)	G5	17800	1,00	600	572	1200	1172	81	8,5	2	360



CLIP-IN



PLL / T16 (T5)

Endirekt Aydınlatma Armatürleri

Indirect Lighting Fixtures

Luminaire Indirects

UYGULAMA ALANLARI

Ofisler
Toplantı Odaları
Mağazalar
Hastaneler
Okullar
Koridorlar

APPLICATION AREAS

Offices
Meeting rooms
Stores
Hospitals
Schools
Corridors

DOMAINES D'UTILISATION

Bureaux
Salles de Réunion
Magasins
Hopitaux
Ecoles
Couloirs

GÖVDE

Elektrostatik toz boyalı sac.

BALAST

ENEC standartlarına uygun, uzun ömürlü sabit ışık akısına sahip, düşük enerji kayıplı (EEI=A2) elektronik balast

BODY

Electrostatic powder coated sheetmetal.

BALLAST

Electronic ballast with long life, low power loss EEI = A2 and constant flux. Compatible with ENEC standards.

CORPS

Feuille de métal peinte électrostatiquement.

BALLAST

Ballast électronique, conforme aux normes ENEC. Longue vie. Perte de puissance faible (EEI=A2). Flux de lumière régulier.

Kod Code	Güç Power Puissance (W)	Ampul Tipi Lamp Type Type De Lampe	Duy Tipi Socket Type Type De Douille	Işık Akısı Lum. Flux Flux Lum. (lm)	Akım Current Courant (A)	Ölçüler Dimensions (mm) a b h	Ağırlık Weight Poids (kg)	Ambalaj Adedi Packing Quantity Colisage	Adet/20" Konteyner Pcs./20" Container Pcs./20" Conteneur
P51C214E	2x14	T16(T5)	G5	2400	0.14	600 600 90	4.2	2	740
P51C224E	2x24	T16(T5)	G5	3500	0.23	600 600 90	4.2	2	740
PKL1C236E	2x36	PLL	2G11	5800	0.32	600 600 90	4.2	2	740
PKL1C255E	2x55	PLL	2G11	9600	0.47	600 600 90	4.3	2	740

V / Hz 220 - 240 / 50 - 60

Opsiyonlar	Options	Options
DIM edilebilir elektronik balast.	Dimmable electronic ballast.	Ballast électronique dimmable.
Acil durum kiti.	Emergency kit.	Kit d'urgence.

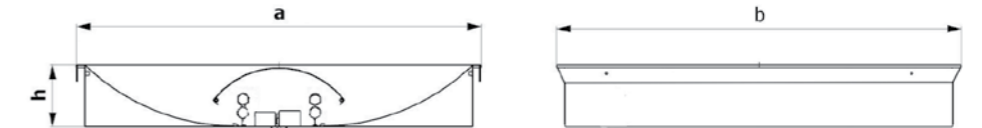



TRIM LINE

Tavan Bağlantı Sistemleri
Ceiling Mounting System
Système de Montage au Plafond

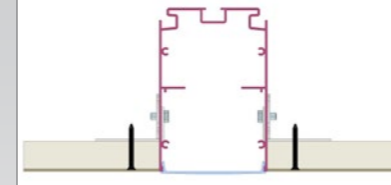

T16 (T5)

Sıva Altı Tek Sıralı Difüzörlü
Aydınlatma Armatürleri

Recessed Single Line Lighting
Fixtures With Diffuser

Luminaire Encastrés Avec
Diffuseur - 1 ligne

UYGULAMA ALANLARI

Alışveriş Merkezleri
Marketler
Ofisler
Toplantı odaları
Mağazalar
Hastaneler
Okullar
Koridorlar

APPLICATION AREAS

Shopping Malls
Supermarkets
Offices
Meeting rooms
Stores
Hospitals
Schools
Corridors

DOMAINES D'UTILISATION

Centres Commerciaux
Supermarchés
Bureaux
Salles de Réunion
Magasins
Hopitaux
Ecoles
Couloirs

T5 Floresanlı Tip / T5 Fluorescent Type / Type T5 Fluorescent

Kod Code	Güç Power Puissance (W)	Ampul Tipi Lamp Type Typ. De Lamp.	Duy Tipi Socket Type Type De Douille	Işık Akısı Lum. Flux Flux Lum. (lm)	Akım Current Courant (A)	Ölçüler Dimensions (mm) a l h	Ağırlık Weight Poids (kg)	Ambalaj Adedi Packing Quantity Colisage	Adet/20" Konteyner Pcs./20" Conteneur
P513A114C	1x14	T16(T5)	G5	1200	0.08	64 581 97	1.4	2	6650
P513A124C	1x24	T16(T5)	G5	1750	0.12	64 581 97	1.4	2	6650
P513A121C	1x21	T16(T5)	G5	1900	0.11	64 881 97	2.0	2	4650
P513A128C	1x28	T16(T5)	G5	2600	0.14	64 1181 97	2.6	2	3470
P513A154C	1x54	T16(T5)	G5	4450	0.26	64 1181 97	2.6	2	3470
P513A135C	1x35	T16(T5)	G5	3300	0.17	64 1481 97	3.2	2	2770
P513A149C	1x49	T16(T5)	G5	4300	0.24	64 1481 97	3.2	2	2770
P513A180C	1x80	T16(T5)	G5	6150	0.38	64 1481 97	3.2	2	2770

V / Hz 220 - 240 / 50 - 60

Opsiyonlar	Options	Options
DIM edilebilir elektronik balast yada konvertör.	Dimmable electronic ballast or convertor.	Ballast électronique dimmable ou converteur.
LED'li modeller için acil durum kiti.	Emergency kit for models with LED	Kit d'urgence pour les modèles LED.



GÖVDE

Zarif tasarıma sahip, beyaz renkli alüminyum.

DİFÜZÖR

UV korumalı PC difüzör.

BALAST

ENEC standartlarına uygun, uzun ömürlü sabit ışık akısına sahip, düşük enerji kayıplı (EEI=A2) elektronik balast

BODY

White colored aluminium.

DIFFUSER

UV stabilized PC diffuser.

BALLAST

Electronic ballast with long life, low power loss EEI = A2 and constant flux. Compatible with ENEC standards.

CORPS

Corps en aluminium de couleur blanc. Design Elegant.

DIFFUSEUR

Diffuseur en PC anti UV.

BALLAST

Ballast électronique a longue vie, perte de puissance réduite EEI = A2 et flux constant. Compatible avec les standards ENEC.



SLIM LINE

Renk Seçenekleri
Color Options
Options de Couleur



T16 (T5)

Sıva Altı Tek Sıralı Difüzörlü
Aydınlatma Armatürleri

Recessed Single Line Lighting
Fixtures With Diffuser

Luminaire Encastrés Avec
Diffuseur - 1 ligne

UYGULAMA ALANLARI

Alışveriş Merkezleri
Marketler
Ofisler
Toplantı odaları
Mağazalar
Hastaneler
Okullar
Koridorlar

APPLICATION AREAS

Shopping Malls
Supermarkets
Offices
Meeting rooms
Stores
Hospitals
Schools
Corridors

DOMAINES D'UTILISATION

Centres Commerciaux
Supermarchés
Bureaux
Salles de Réunion
Magasins
Hopitaux
Ecoles
Couloirs

GÖVDE

Zarif tasarıma sahip, gümüş ve beyaz renk seçenekli alüminyum.

DİFÜZÖR

UV korumalı PC difüzör.

BALAST

ENEC standartlarına uygun, uzun ömürlü sabit ışık akısına sahip, düşük enerji kayıplı (EEI=A2) elektronik balast

BODY

White or silver color options aluminum.

DIFFUSER

UV stabilized PC diffuser.

BALLAST

Electronic ballast with long life, low power loss EEI = A2 and constant flux. Compatible with ENEC standards.

CORPS

Corps en aluminium de couleurs argent et blanc disponibles. Design Elegant.

DIFFUSEUR

Diffuseur en PC anti UV.

BALLAST

Ballast électronique a longue vie, perte de puissance réduite EEI = A2 et flux constant. Compatible avec les standards ENEC.

T5 Floresanlı Tip / T5 Fluorescent Type / Type T5 Fluorescent

Kod Code	Güç Power Puissance (W)	Ampul Tipi Lamp Type Typ. De Lamp.	Duy Tipi Socket Type Type De Douille	Işık Akısı Lum. Flux Flux Lum. (lm)	Akım Current Courant (A)	Ölçüler Dimensions (mm)			Ağırlık Weight Poids (kg)	Ambalaj Adedi Packing Quantity Colisage	Adet/20" Konteyner Pcs./20" Conteneur
						a	l	h			
P514A114C	1x14	T16(T5)	G5	1200	0.08	57	581	85	1.4	2	8330
P514A124C	1x24	T16(T5)	G5	1750	0.12	57	581	85	1.4	2	8330
P514A121C	1x21	T16(T5)	G5	1900	0.11	57	881	85	2.0	2	5870
P514A128C	1x28	T16(T5)	G5	2600	0.14	57	1181	85	2.6	2	4380
P514A154C	1x54	T16(T5)	G5	4450	0.26	57	1181	85	2.6	2	4380
P514A135C	1x35	T16(T5)	G5	3300	0.17	57	1481	85	3.2	2	3500
P514A149C	1x49	T16(T5)	G5	4300	0.24	57	1481	85	3.2	2	3500
P514A180C	1x80	T16(T5)	G5	6150	0.38	57	1481	85	3.2	2	3500

V / Hz 220 - 240 / 50 - 60

Opsiyonlar	Options	Options
DIM edilebilir elektronik balast yada konvertör.	Dimmable electronic ballast or convertor.	Ballast électronique dimmable ou converteur.
LED' li modeller için acil durum kiti.	Emergency kit for models with LED	Kit d'urgence pour les modèles LED.

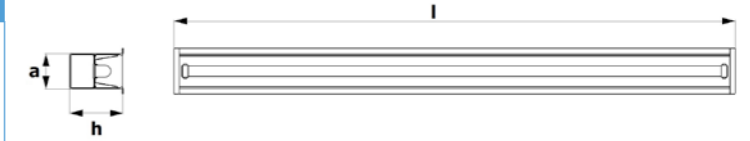





PROLINE

T16 (T5)

Sıva Üstü Tek Sıralı Beyaz Reflektörlü Aydınlatma Armatürleri

Surface Mounted Single Line Lighting Fixtures With White Reflector

Luminaire Apparents Avec Reflecteur Blanc - 1 ligne

UYGULAMA ALANLARI

Alışveriş Merkezleri
Marketler
Ofisler
Toplantı odaları
Mağazalar
Hastaneler
Okullar
Koridorlar

APPLICATION AREAS

Shopping Malls
Supermarkets
Offices
Meeting rooms
Stores
Hospitals
Schools
Corridors

DOMAINES D'UTILISATION

Centres Commerciaux
Supermarchés
Bureaux
Salles de Réunion
Magasins
Hopitaux
Ecoles
Couloirs

GÖVDE

Gümüş renkli, zarif tasarıma sahip, saten eloksal kaplamalı alüminyum.

REFLEKTÖR

Yüksek yansıtma performansına sahip ışığın verimli bir şekilde dağılımını sağlayan zarif tasarımı elektrostatik toz boyalı alüminyum.

BALLAST

ENEC standartlarına uygun, uzun ömürlü sabit ışık akısına sahip, düşük enerji kayıplı (EEI=A2) elektronik balast

BODY

Anodized aluminum with satin finishing, elegant design with silver color.

REFLECTOR

Electrostatic powder coated aluminum reflector with elegant design and high reflection performance enabling efficient distribution of the light to the targeted area.

BALLAST

Electronic ballast with long life, low power loss EEI = A2 and constant flux. Compatible with ENEC standards.

CORPS

Corps couleur argent en aluminium anodisé et satiné. Design élégant.

REFLECTEUR

Reflecteur en aluminium anodisé. Design élégant. Assure une diffusion efficace de la lumière vers l'endroit ciblé.

BALLAST

Ballast électronique a longue vie, perte de puissance réduite EEI = A2 et flux constant. Compatible avec les standards ENEC.



Kod Code	Güç Power Puissance (W)	Ampul Tipi Lamp Type Typ. De Lamp.	Duy Tipi Socket Type Type De Douille	Işık Akısı Lum. Flux Flux Lum. (lm)	Akım Current Courant (A)	Ölçüler Dimensions (mm) a b h	Ağırlık Weight Poids (kg)	Ambalaj Adedi Packing Quantity Colisage	Adet/20" Konteyner Pcs./20" Conteneur	Resim No Drawing No Dessin No
P52U128R	1x28	T16(T5)	G5	2600	0.14	150 1185 62	2.22	2	2040	1
P52U154R	1x54	T16(T5)	G5	4450	0.26	150 1185 62	2.22	2	2040	
P52U135R	1x35	T16(T5)	G5	3300	0.17	150 1485 62	2.90	2	1770	
P52U149R	1x49	T16(T5)	G5	4300	0.24	150 1485 62	2.90	2	1770	
P52U180R	1x80	T16(T5)	G5	6150	0.38	150 1485 62	2.90	2	1770	
P52U228R	2x28	T16(T5)	G5	5200	0.26	150 2360 62	4.20	2	1110	2
P52U254R	2x54	T16(T5)	G5	8900	0.50	150 2360 62	4.20	2	1110	
P52U235R	2x35	T16(T5)	G5	6600	0.33	150 2960 62	5.50	2	890	
P52U249R	2x49	T16(T5)	G5	8600	0.49	150 2960 62	5.50	2	890	
P52U280R	2x80	T16(T5)	G5	12300	0.76	150 2960 62	5.50	2	890	

V / Hz 220 - 240 / 50 - 60

Opsiyonlar Options Options

DIM edilebilir elektronik balast. Acil durum kiti. Dimmable electronic ballast. Emergency kit. Ballast électronique dimmable. Kit d'urgence.

Askı: 1mm çelik örgü tel ve nikel kaplamalı pirinç parçalardan mamul, askı boyu ayarlanabilir, şeffaf elektrik kablosu ve tavana monte edilen, estetik tasarıma sahip elektrik bağlantı kutusu ile birlikte.

Suspension: Composed of 1mm steel wire rope and nickel-plated brass components. Suspension height is adjustable. Supplied with transparent electric cord and ceiling mounted electrical junction box with aesthetic design.

Fixation: Comprend un cable en acier de 1 mm et des composants en laiton nickelé. Livré avec un cordon électrique transparent, une boîte de jonction électrique au design esthétique, à fixer au plafond.

P52U135R

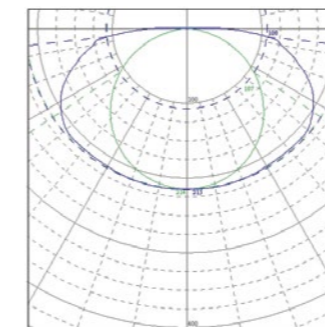

CO - C180
C90 - C270

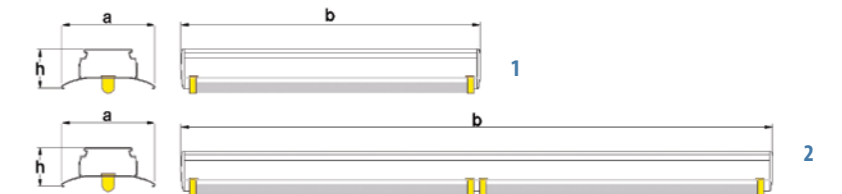



PROLINE



T16 (T5)

Sıva Üstü Çift Sıralı Beyaz Reflektörlü Aydınlatma Armatürleri

Surface Mounted Double Line Lighting Fixtures With White Reflector

Luminaires Apparents Avec Reflecteur Blanc - 2 lignes

UYGULAMA ALANLARI

Alışveriş Merkezleri
Marketler
Ofisler
Toplantı odaları
Mağazalar
Hastaneler
Okullar
Koridorlar

APPLICATION AREAS

Shopping Malls
Supermarkets
Offices
Meeting rooms
Stores
Hospitals
Schools
Corridors

DOMAINES D'UTILISATION

Centres Commerciaux
Supermarchés
Bureaux
Salles de Réunion
Magasins
Hopitaux
Ecoles
Couloirs

GÖVDE

Gümüş renkli, zarif tasarıma sahip, saten elok-sal kaplamalı alüminyum.

REFLEKTÖR

Yüksek yansıtma performansına sahip ışığın verimli bir şekilde dağılımını sağlayan zarif tasarımı elektrostatik toz boyalı alüminyum.

BALAST

ENEC standartlarına uygun, uzun ömürlü sabit ışık akısına sahip, düşük enerji kayıplı (EEI=A2) elektronik balast

BODY

Anodized aluminum with satin finishing, elegant design with silver color.

REFLECTOR

Electrostatic powder coated aluminum reflector with elegant design and high reflection performance enabling efficient distribution of the light to the targeted area.

BALLAST

Electronic ballast with long life, low power loss EEI = A2 and constant flux. Compatible with ENEC standards.

CORPS

Corps couleur argent en aluminium anodisé et satiné . Design élégant.

REFLECTEUR

Reflecteur en aluminium enduit de peinture électrostatique. Design élégant. Assure une répartition efficace de la lumière vers l'endroit ciblé.

BALLAST

Ballast électronique a longue vie, perte de puissance réduite EEI = A2 et flux constant. Compatible avec les standards ENEC.

Kod Code	Güç Power Puissance (W)	Ampul Tipi Lamp Type Type De Lampe	Duy Tipi Socket Type Type De Douille	Işık Akısı Lum. Flux Flux Lum. (lm)	Akım Current Courant (A)	Ölçüler Dimensions (mm) a b h	Ağırlık Weight Poids (kg)	Ambalaj Adedi Packing Quantity Colisage	Adet/20" Konteyner Pcs./20" Container Pcs./20" Conteneur	Resim No Drawing No Dessin No
P52U228R2	2x28	T16(T5)	G5	5200	0.26	150 62 1185	2.40	2	2040	1
P52U254R2	2x54	T16(T5)	G5	8900	0.50	150 62 1185	2.40	2	2040	
P52U235R2	2x35	T16(T5)	G5	6600	0.33	150 62 1485	2.95	2	1770	
P52U249R2	2x49	T16(T5)	G5	8600	0.49	150 62 1485	2.95	2	1770	
P52U280R2	2x80	T16(T5)	G5	12300	0.76	150 62 1485	2.95	2	1770	2
P52U428R2	4x28	T16(T5)	G5	10400	0.52	150 62 2360	4.80	2	1110	
P52U454R2	4x54	T16(T5)	G5	17800	1.00	150 62 2360	4.80	2	1110	
P52U435R2	4x35	T16(T5)	G5	13200	0.66	150 62 2960	5.90	2	890	
P52U449R2	4x49	T16(T5)	G5	17200	0.98	150 62 2960	5.90	2	890	
P52U480R2	4x80	T16(T5)	G5	24600	1.52	150 62 2960	5.90	2	890	

V / Hz 220 - 240 / 50 - 60

P52U235R

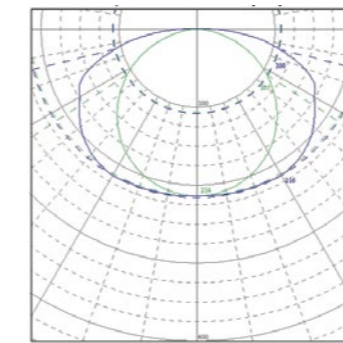

CO - C180
C90 - C270

Opsiyonlar Options Options

DIM edilebilir elektronik balast. Acil durum kiti. Dimmable electronic ballast. Emergency kit. Ballast électronique dimmable. Kit d'urgence.

Askı: 1mm çelik örgü tel ve nikel kaplamalı piriç parçalarından mamul, askı boyu ayarlanabilir, şeffaf elektrik kablosu ve tavana monte edilen, estetik tasarıma sahip elektrik bağlantı kutusu ile birlikte.

Suspension: Composed of 1mm steel wire rope and nickel-plated brass components. Suspension height is adjustable. Supplied with transparent electric cord and ceiling mounted electrical junction box with aesthetic design.

Fixation: Comprend un câble en acier de 1 mm et des composants en laiton nickelé. Livré avec un cordon électrique transparent, une boîte de jonction électrique au design esthétique, à fixer au plafond.

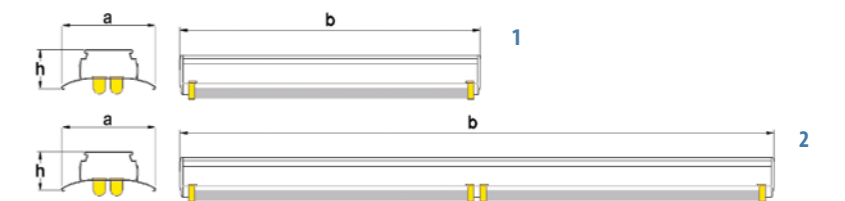

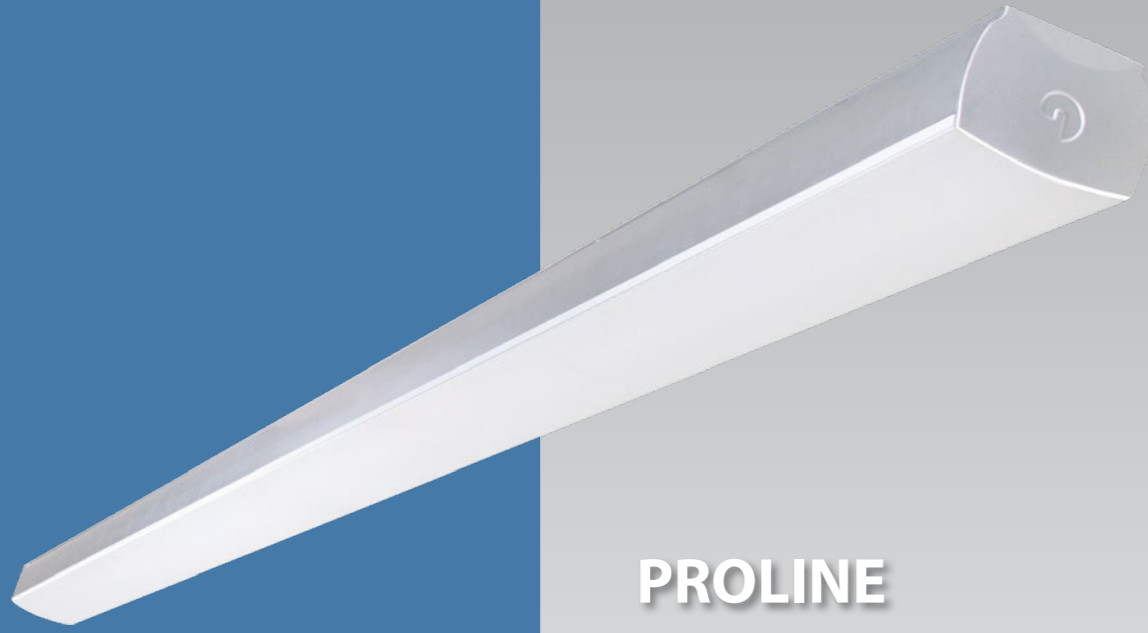

PROLINE



LED

Sıva Üstü Difüzlü Aydınlatma Armatürleri

Surface Mounted Lighting Fixtures With Diffuser

Luminares Apparents Avec Diffuseur

UYGULAMA ALANLARI

Alışveriş Merkezleri
Marketler
Ofisler
Toplantı odaları
Mağazalar
Hastaneler
Okullar
Koridorlar

APPLICATION AREAS

Shopping Malls
Supermarkets
Offices
Meeting rooms
Stores
Hospitals
Schools
Corridors

DOMAINES D'UTILISATION

Centres Commerciaux
Supermarchés
Bureaux
Salles de Réunion
Magasins
Hopitaux
Ecoles
Couloirs

GÖVDE

Gümüş renkli, zarif tasarıma sahip, saten eloksal kaplamalı alüminyum.

DİFÜZÖR

UV korumalı PC difüzör

KONVERTÖR

ENEC standartlarına uygun, uzun ömürlü sabit akımlı konvertör.

LED

50.000 saat ömürlü LUMILEDS / OSRAM / SEOUL marka LED'li LED modüller.

BODY

Anodized aluminum with satin finishing, elegant design with silver color.

DIFFUSER

UV stabilized PC diffuser.

CONVERTER

Long life, low power loss converter with constant current. Compatible with ENEC standards.

LED

LED modules with 50,000 hours lifetime LUMILEDS / OSRAM / SEOUL brand LEDs.

CORPS

Corps en aluminium anodisé, satiné. Design Elegant Couleur Argent.

DIFFUSEUR

Diffuseur en PC anti UV.

CONVERTEUR

Convertisseur, conforme aux normes ENEC. Longue vie. Perte de puissance faible avec courant constant.

LED

Modules LED – Durée de vie 50.000 heures avec LED de marque LUMILEDS / OSRAM / SEOUL.

V / Hz 220 - 240 / 50 - 60



Renk Geri Verim Indexi / Color Rendering Index / Indice de Rendu des Couleurs: (CRI): Ra>80

Kod Code	Güç Power Puissance (W)	LED Tipi LED Type Type De LED	LED Modül LED Module Module LED	Işık Akısı Lum. Flux Flux Lum. (lm)	Renk Sıcaklığı Color Temperature Température De Couleur (K)	Ölçüler Dimensions (mm)			Ağırlık Weight Poids (kg)	Ambalaj Adedi Packing Quantity Colisage	Adet/20" Konteyner Pcs./20" Container
						a	b	h			
PL2U12L15C	2x6,5	3535 SMD	PCB	1700	3000 / 4000 / 6500	98	575	76	1.0	2	6100
PL2U12L15CSB	2x6,5	3535 SMD	PCB	1700	3000 / 4000 / 6500	98	573	76	0.9	2	6100
PL2U12L15CSO	2x6,5	3535 SMD	PCB	1700	3000 / 4000 / 6500	98	571	76	0.8	2	6100
PL2U12L25C	2x12	3535 SMD	PCB	3100	3000 / 4000 / 6500	98	575	76	1.0	2	6100
PL2U12L25CSB	2x12	3535 SMD	PCB	3100	3000 / 4000 / 6500	98	573	76	0.9	2	6100
PL2U12L25CSO	2x12	3535 SMD	PCB	3100	3000 / 4000 / 6500	98	571	76	0.8	2	6100
PL2U13L15C	3x6,5	3535 SMD	PCB	2550	3000 / 4000 / 6500	98	855	76	1.6	2	4100
PL2U13L15CSB	3x6,5	3535 SMD	PCB	2550	3000 / 4000 / 6500	98	853	76	1.5	2	4100
PL2U13L15CSO	3x6,5	3535 SMD	PCB	2550	3000 / 4000 / 6500	98	851	76	1.4	2	4100
PL2U13L25C	3x12	3535 SMD	PCB	4650	3000 / 4000 / 6500	98	855	76	1.6	2	4100
PL2U13L25CSB	3x12	3535 SMD	PCB	4650	3000 / 4000 / 6500	98	853	76	1.5	2	4100
PL2U13L25CSO	3x12	3535 SMD	PCB	4650	3000 / 4000 / 6500	98	851	76	1.4	2	4100
PL2U14L15C	4x6,5	3535 SMD	PCB	3400	3000 / 4000 / 6500	98	1135	76	2.2	2	3100
PL2U14L15CSB	4x6,5	3535 SMD	PCB	3400	3000 / 4000 / 6500	98	1133	76	2.1	2	3100
PL2U14L15CSO	4x6,5	3535 SMD	PCB	3400	3000 / 4000 / 6500	98	1131	76	2.0	2	3100
PL2U14L25C	4x12	3535 SMD	PCB	6200	3000 / 4000 / 6500	98	1135	76	2.2	2	3100
PL2U14L25CSB	4x12	3535 SMD	PCB	6200	3000 / 4000 / 6500	98	1133	76	2.1	2	3100
PL2U14L25CSO	4x12	3535 SMD	PCB	6200	3000 / 4000 / 6500	98	1131	76	2.0	2	3100
PL2U15L15C	5x6,5	3535 SMD	PCB	4250	3000 / 4000 / 6500	98	1416	76	2.7	2	2470
PL2U15L15CSB	5x6,5	3535 SMD	PCB	4250	3000 / 4000 / 6500	98	1414	76	2.6	2	2470
PL2U15L15CSO	5x6,5	3535 SMD	PCB	4250	3000 / 4000 / 6500	98	1412	76	2.5	2	2470
PL2U15L25C	5x12	3535 SMD	PCB	7750	3000 / 4000 / 6500	98	1416	76	2.7	2	2470
PL2U15L25CSB	5x12	3535 SMD	PCB	7750	3000 / 4000 / 6500	98	1414	76	2.6	2	2470
PL2U15L25CSO	5x12	3535 SMD	PCB	7750	3000 / 4000 / 6500	98	1412	76	2.5	2	2470
PL2U16L15C	6x6,5	3535 SMD	PCB	5100	3000 / 4000 / 6500	98	1696	76	3.3	2	2060
PL2U16L15CSB	6x6,5	3535 SMD	PCB	5100	3000 / 4000 / 6500	98	1694	76	3.2	2	2060
PL2U16L15CSO	6x6,5	3535 SMD	PCB	5100	3000 / 4000 / 6500	98	1692	76	3.1	2	2060
PL2U16L25C	6x12	3535 SMD	PCB	9300	3000 / 4000 / 6500	98	1696	76	3.3	2	2060
PL2U16L25CSB	6x12	3535 SMD	PCB	9300	3000 / 4000 / 6500	98	1694	76	3.2	2	2060
PL2U16L25CSO	6x12	3535 SMD	PCB	9300	3000 / 4000 / 6500	98	1692	76	3.1	2	2060
PL2U17L15C	7x6,5	3535 SMD	PCB	5950	3000 / 4000 / 6500	98	1977	76	3.8	2	1760
PL2U17L15CSB	7x6,5	3535 SMD	PCB	5950	3000 / 4000 / 6500	98	1975	76	3.7	2	1760
PL2U17L15CSO	7x6,5	3535 SMD	PCB	5950	3000 / 4000 / 6500	98	1973	76	3.6	2	1760
PL2U18L15C	8x6,5	3535 SMD	PCB	6800	3000 / 4000 / 6500	98	2257	76	4.3	2	1540
PL2U18L15CSB	8x6,5	3535 SMD	PCB	6800	3000 / 4000 / 6500	98	2255	76	4.2	2	1540
PL2U18L15CSO	8x6,5	3535 SMD	PCB	6800	3000 / 4000 / 6500	98	2253	76	4.1	2	1540
PL2U19L15C	9x6,5	3535 SMD	PCB	7650	3000 / 4000 / 6500	98	2538	76	4.8	2	1360
PL2U19L15CSB	9x6,5	3535 SMD	PCB	7650	3000 / 4000 / 6500	98	2536	76	4.7	2	1360
PL2U19L15CSO	9x6,5	3535 SMD	PCB	7650	3000 / 4000 / 6500	98	2534	76	4.6	2	1360
PL2U10L15C	10x6,5	3535 SMD	PCB	8500	3000 / 4000 / 6500	98	2818	76	5.3	2	1220
PL2U10L15CSB	10x6,5	3535 SMD	PCB	8500	3000 / 4000 / 6500	98	2816	76	5.2	2	1220
PL2U10L15CSO	10x6,5	3535 SMD	PCB	8500	3000 / 4000 / 6500	98	2814	76	5.1	2	1220
PL2U11L15C	11x6,5	3535 SMD	PCB	9350	3000 / 4000 / 6500	98	3099	76	5.8	2	1110
PL2U11L15CSB	11x6,5	3535 SMD	PCB	9350	3000 / 4000 / 6500	98	3097	76	5.7	2	1110
PL2U11L15CSO	11x6,5	3535 SMD	PCB	9350	3000 / 4000 / 6500	98	3095	76	5.6	2	1110

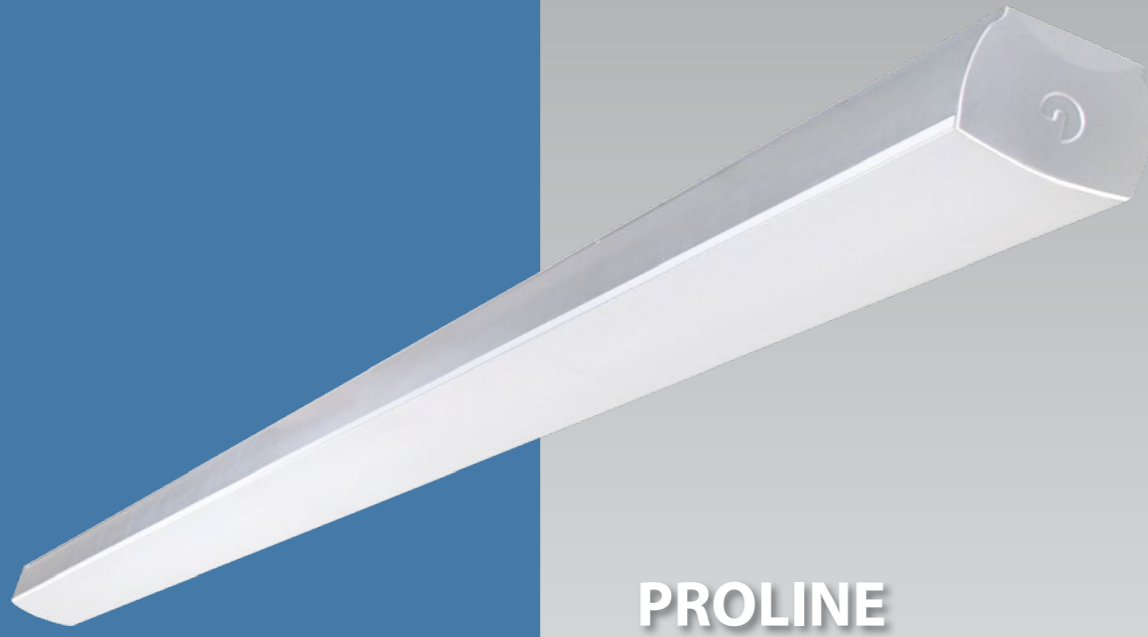

PROLINE

P52U135C

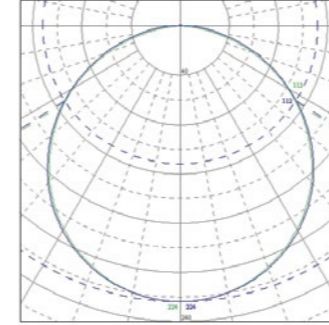

C0 - C180
C90 - C270



T16 (T5)

Sıva Üstü Tek Sıralı Difüzörlü
Aydınlatma Armatürleri

Surface Mounted Single Line Lighting

Fixtures With Diffuser

Luminaire Apparents Avec

Diffuseur - 1 ligne

UYGULAMA ALANLARI

Alışveriş Merkezleri
Marketler
Ofisler
Toplantı odaları
Mağazalar
Hastaneler
Okullar
Koridorlar

APPLICATION AREAS

Shopping Malls
Supermarkets
Offices
Meeting rooms
Stores
Hospitals
Schools
Corridors

DOMAINES D'UTILISATION

Centres Commerciaux
Supermarchés
Bureaux
Salles de Réunion
Magasins
Hopitaux
Ecoles
Couloirs

GÖVDE

Gümüş renkli, zarif tasarıma sahip, saten elok-sal kaplamalı alüminyum.

DİFÜZÖR

UV korumalı PC difüzör

BALAST

ENEC standartlarına uygun, uzun ömürlü sabit ışık akısına sahip, düşük enerji kayıplı (EEI=A2) elektronik balast.

BODY

Anodized aluminum with satin finishing, elegant design with silver color.

DIFFUSER

UV stabilized PC diffuser.

BALLAST

Electronic ballast with long life, low power loss EEI = A2 and constant flux. Compatible with ENEC standards.

CORPS

Corps en aluminium anodisé, satiné. Design Elegant Couleur Argent.

DIFFUSEUR

Diffuseur en PC anti UV.

BALLAST

Ballast électronique, conforme aux normes ENEC. Longue vie. Perte de puissance faible (EEI = A2). Flux de lumière régulier.

Kod Code	Güç Power Puissance (W)	Ampul Tipi Lamp Type Type De Lampe	Duy Tipi Socket Type Type De Douille	Işık Akısı Lum. Flux Flux Lum. (lm)	Akım Current Courant (A)	Ölçüler Dimensions (mm) a b h	Ağırlık Weight Poids (kg)	Ambalaj Adedi Packing Quantity Colisage	Adet/20" Konteyner Pcs./20" Conteneur	Resim No Drawing No Dessin No
P52U128C	1x28	T16(T5)	G5	2600	0.14	98 1183 76	2.70	2	3100	1
P52U128CSB	1x28	T16(T5)	G5	2600	0.14	98 1119 76	2.60	2	3100	
P52U128CSO	1x28	T16(T5)	G5	2600	0.14	98 1150 76	2.40	2	3100	
P52U154C	1x54	T16(T5)	G5	4450	0.26	98 1183 76	2.70	2	3100	
P52U154CSB	1x54	T16(T5)	G5	4450	0.26	98 1119 76	2.60	2	3100	
P52U154CSO	1x54	T16(T5)	G5	4450	0.26	98 1150 76	2.40	2	3100	
P52U135C	1x35	T16(T5)	G5	3300	0.17	98 1483 76	3.20	2	2470	
P52U135CSB	1x35	T16(T5)	G5	3300	0.17	98 1419 76	3.10	2	2470	
P52U135CSO	1x35	T16(T5)	G5	3300	0.17	98 1350 76	2.90	2	2470	
P52U149C	1x49	T16(T5)	G5	4300	0.24	98 1483 76	3.20	2	2470	
P52U149CSB	1x49	T16(T5)	G5	4300	0.24	98 1419 76	3.10	2	2470	
P52U149CSO	1x49	T16(T5)	G5	4300	0.24	98 1350 76	2.90	2	2470	
P52U180C	1x80	T16(T5)	G5	6150	0.38	98 1483 76	3.20	2	2470	
P52U180CSB	1x80	T16(T5)	G5	6150	0.38	98 1419 76	3.10	2	2470	
P52U180CSO	1x80	T16(T5)	G5	6150	0.38	98 1350 76	2.90	2	2470	
P52U228C	2x28	T16(T5)	G5	5200	0.26	98 2240 76	4.70	2	1580	
P52U228CSB	2x28	T16(T5)	G5	5200	0.26	98 2170 76	4.50	2	1580	
P52U228CSO	2x28	T16(T5)	G5	5200	0.26	98 2100 76	4.40	2	1580	
P52U254C	2x54	T16(T5)	G5	8900	0.50	98 2240 76	4.70	2	1580	
P52U254CSB	2x54	T16(T5)	G5	8900	0.50	98 2170 76	4.50	2	1580	
P52U254CSO	2x54	T16(T5)	G5	8900	0.50	98 2100 76	4.40	2	1580	
P52U235C	2x35	T16(T5)	G5	6600	0.33	98 2840 76	5.90	2	1250	
P52U235CSB	2x35	T16(T5)	G5	6600	0.33	98 2770 76	5.80	2	1250	
P52U235CSO	2x35	T16(T5)	G5	6600	0.33	98 2700 76	5.60	2	1250	
P52U249C	2x49	T16(T5)	G5	8600	0.49	98 2840 76	5.90	2	1250	
P52U249CSB	2x49	T16(T5)	G5	8600	0.49	98 2770 76	5.80	2	1250	
P52U249CSO	2x49	T16(T5)	G5	8600	0.49	98 2700 76	5.60	2	1250	
P52U280C	2x80	T16(T5)	G5	12300	0.76	98 2840 76	5.90	2	1250	
P52U280CSB	2x80	T16(T5)	G5	12300	0.76	98 2770 76	5.80	2	1250	
P52U280CSO	2x80	T16(T5)	G5	12300	0.76	98 2700 76	5.60	2	1250	

Opsiyonlar	Options	Options
DIM edilebilir balast ya da konvertör. Acil durum kiti.	Dimmable ballast or converter. Emergency kit.	Ballast dimmable ou converteur. Kit d'urgence.

	Askı: 1mm çelik örgü tel ve nikel kaplamalı pirinç parçalardan mamul, askı boyu ayarlanabilir, şeffaf elektrik kablosu ve tavana monte edilen, estetik tasarıma sahip elektrik bağlantı kutusu ile birlikte.	Suspension: Composed of 1mm steel wire rope and nickel-plated brass components. Suspension height is adjustable. Supplied with transparent electric cord and ceiling mounted electrical junction box with aesthetic design.	Fixation: Comprend un cable en acier de 1 mm et des composants en laiton nickelé. Livré avec un cordon électrique transparent, une boîte de jonction électrique au design esthétique, a fixer au plafond.
--	---	--	--

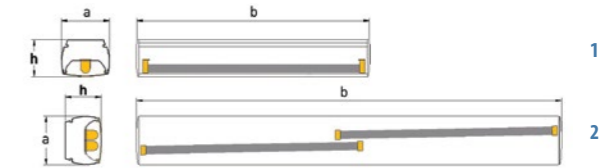

V / Hz 220 - 240 / 50 - 60



PROLINE



T16 (T5)

Sıva Üstü Çift Sıralı Difüzörlü Aydınlatma Armatürleri

Surface Mounted Double Line Lighting

Fixtures With Diffuser

Luminares Apparents Avec

Diffuseur - 2 lignes

UYGULAMA ALANLARI

Alışveriş Merkezleri
Marketler
Ofisler
Toplantı odaları
Mağazalar
Hastaneler
Okullar
Koridorlar

APPLICATION AREAS

Shopping Malls
Supermarkets
Offices
Meeting rooms
Stores
Hospitals
Schools
Corridors

DOMAINES D'UTILISATION

Centres Commerciaux
Supermarchés
Bureaux
Salles de Réunion
Magasins
Hopitaux
Ecoles
Couloirs

GÖVDE

Gümüş renkli, zarif tasarıma sahip, saten elok-sal kaplamalı alüminyum.

DİFÜZÖR

UV korumalı PC difüzör

BALAST

ENEC standartlarına uygun, uzun ömürlü sabit ışık akısına sahip, düşük enerji kayıplı (EEI=A2) elektronik balast.

BODY

Anodized aluminum with satin finishing, elegant design with silver color.

DIFFUSER

UV stabilized PC diffuser.

BALLAST

Electronic ballast with long life, low power loss EEI = A2 and constant flux. Compatible with ENEC standards.

CORPS

Corps en aluminium anodisé, satiné. Design Elegant Couleur Argent.

DIFFUSEUR

Diffuseur en PC anti UV.

BALLAST

Ballast électronique, conforme aux normes ENEC. Longue vie. Perte de puissance faible (EEI = A2). Flux de lumière régulier.

Kod Code	Güç Power Puissance (W)	Ampul Tipi Lamp Type Type De Lampe	Duy Tipi Socket Type Type De Douille	Işık Akısı Lum. Flux Flux Lum. (lm)	Akım Current Courant (A)	Ölçüler Dimensions (mm)			Ağırlık Weight Poids (kg)	Ambalaj Adedi Packing Quantity Colisage	Adet/20" Konteyner Pcs./20" Container Pcs./20" Conteneur
						a	b	h			
P52U228C2	2x28	T16(T5)	G5	5200	0.26	98	1185	75	2.82	2	2960
P52U254C2	2x54	T16(T5)	G5	8900	0.50	98	1185	75	2.82	2	2960
P52U235C2	2x35	T16(T5)	G5	6600	0.33	98	1485	75	3.41	2	2370
P52U249C2	2x49	T16(T5)	G5	8600	0.49	98	1485	75	3.41	2	2370
P52U280C2	2x80	T16(T5)	G5	12300	0.76	98	1485	75	3.41	2	2370

V / Hz 220 - 240 / 50 - 60

Opsiyonlar	Options	Options
DİM edilebilir balast ya da konvertör.	Dimmable ballast or converter.	Ballast dimmable ou converteur.
Acil durum kiti.	Emergency kit.	Kit d'urgence.



Aski: 1mm çelik örgü tel ve nikel kaplamalı pirinç parçalardan mamul, askı boyu ayarlanabilir, şeffaf elektrik kablosu ve tavana monte edilen, estetik tasarıma sahip elektrik bağlantı kutusu ile birlikte.

Suspension: Composed of 1mm steel wire rope and nickel-plated brass components. Suspension height is adjustable. Supplied with transparent electric cord and ceiling mounted electrical junction box with aesthetic design.

Fixation: Comprend un cable en acier de 1 mm et des composants en laiton nickelé. Livré avec un cordon électrique transparent, une boîte de jonction électrique au design esthétique, à fixer au plafond.

P52U235C

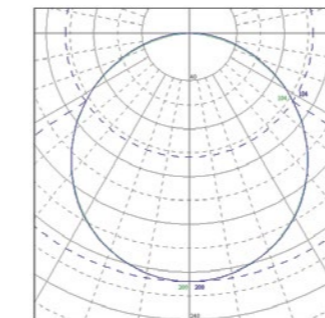

CO - C180

C90 - C270

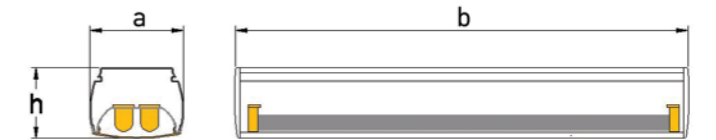



PROLINE

T16 (T5)

Sıva Üstü Tek Sıralı Klasik
Aydınlatma Armatürleri
Surface Mounted Single Line Classic
Lighting Fixtures
Luminaires Apparents
Classic - 1 ligne

UYGULAMA ALANLARI

Alışveriş Merkezleri
Marketler
Ofisler
Toplantı odaları
Mağazalar
Hastaneler
Okullar
Koridorlar

APPLICATION AREAS

Shopping Malls
Supermarkets
Offices
Meeting rooms
Stores
Hospitals
Schools
Corridors

DOMAINES D'UTILISATION

Centres Commerciaux
Supermarchés
Bureaux
Salles de Réunion
Magasins
Hopitaux
Ecoles
Couloirs

GÖVDE

Gümüş renkli, zarif tasarıma sahip, saten elok-sal kaplamalı alüminyum.

REFLEKTÖR

Yüksek yansıtma performansına sahip ışığın verimli bir şekilde dağılımını sağlayan zarif tasarımı elektrostatik toz boyalı alüminyum.

BALAST

ENEC standartlarına uygun, uzun ömürlü sabit ışık akısına sahip, düşük enerji kayıplı (EEI=A2) elektronik balast

BODY

Anodized aluminum with satin finishing, elegant design with silver color.

REFLECTOR

Anodized aluminum reflector with elegant design and high reflection performance enabling efficient distribution of the light to the targeted area.

BALLAST

Electronic ballast with long life, low power loss EEI = A2 and constant flux. Compatible with ENEC standards.

CORPS

Corps couleur argent en aluminium anodisé. Design elegant.

REFLECTEUR

Reflecteur en aluminium enduit de peinture électrostatique. Design elegant. Assure une repartition efficace de la lumière vers l'endroit ciblé.

BALLAST

Ballast électronique. Conforme aux normes ENEC. Longue vie. Perte de puissance faible (EEI=A2). Flux de lumière régulier.



Kod Code	Güç Power Puissance (W)	Ampul Tipi Lamp Type Type De Lampe	Duy Tipi Socket Type Type De Douille	Işık Akısı Lum. Flux Flux Lum. (lm)	Akım Current Courant (A)	Ölçüler Dimensions (mm) a b h	Ağırlık Weight Poids (kg)	Ambalaj Adedi Packing Quantity Colisage	Adet/20" Konteyner Pcs./20" Conteneur	Resim No Drawing No Dessin No
P52U128K	1x28	T16(T5)	G5	2600	0.14	98 1185 68	2.35	2	2960	1
P52U154K	1x54	T16(T5)	G5	4450	0.26	98 1185 68	2.35	2	2960	
P52U135K	1x35	T16(T5)	G5	3300	0.17	98 1485 68	2.90	2	2370	
P52U149K	1x49	T16(T5)	G5	4300	0.24	98 1485 68	2.90	2	2370	
P52U180K	1x80	T16(T5)	G5	6150	0.38	98 1485 68	2.90	2	2370	
P52U228K	2x28	T16(T5)	G5	5200	0.26	98 2360 68	4.40	2	1490	2
P52U254K	2x54	T16(T5)	G5	8900	0.50	98 2360 68	4.40	2	1490	
P52U235K	2x35	T16(T5)	G5	6600	0.33	98 2960 68	5.50	2	1190	
P52U249K	2x49	T16(T5)	G5	8600	0.49	98 2960 68	5.50	2	1190	
P52U280K	2x80	T16(T5)	G5	12300	0.76	98 2960 68	5.50	2	1190	

V / Hz 220 - 240 / 50 - 60

Opsiyonlar Options Options

DIM edilebilir elektronik balast. Acil durum kiti. Dimmable electronic ballast. Emergency kit. Ballast électronique dimmable. Kit d'urgence.



Aski: 1mm çelik örgü tel ve nikel kaplamalı pirinç parçalardan mamul, askı boyu ayarlanabilir, şeffaf elektrik kablosu ve tavana monte edilen, estetik tasarıma sahip elektrik bağlantı kutusu ile birlikte.

Suspension: Composed of 1mm steel wire rope and nickel-plated brass components. Suspension height is adjustable. Supplied with transparent electric cord and ceiling mounted electrical junction box with aesthetic design.

Fixation: Comprend un câble en acier de 1 mm et des composants en laiton nickelé. Livré avec un cordon électrique transparent, une boîte de jonction électrique au design esthétique, à fixer au plafond.

P52U135K

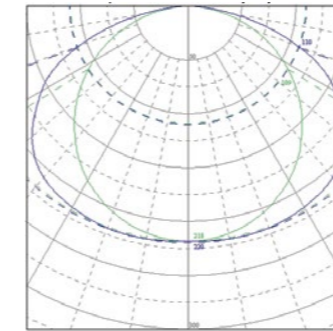

CO - C180
C90 - C270

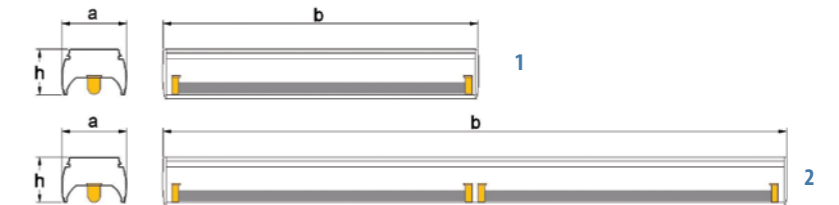



PROLINE

T16 (T5)

Sıva Üstü Çift Sıralı Klasik Aydınlatma Armatürleri
Surface Mounted Double Line Classic Lighting Fixtures
Luminaires Apparents Classic - 2 lignes

UYGULAMA ALANLARI

Alışveriş Merkezleri
Marketler
Ofisler
Toplantı odaları
Mağazalar
Hastaneler
Okullar
Koridorlar

APPLICATION AREAS

Shopping Malls
Supermarkets
Offices
Meeting rooms
Stores
Hospitals
Schools
Corridors

DOMAINES D'UTILISATION

Centres Commerciaux
Supermarchés
Bureaux
Salles de Réunion
Magasins
Hopitaux
Ecoles
Couloirs

GÖVDE

Gümüş renkli, zarif tasarıma sahip, saten elok-sal kaplamalı alüminyum.

REFLEKTÖR

Yüksek yansıtma performansına sahip ışığın verimli bir şekilde dağılımını sağlayan zarif tasarımlı elektrostatik toz boyalı alüminyum.

BALAST

ENEC standartlarına uygun, uzun ömürlü sabit ışık akısına sahip, düşük enerji kayıplı (EEI=A2) elektronik balast

BODY

Anodized aluminum with satin finishing, elegant design with silver color.

REFLECTOR

Electrostatic powder coated aluminum reflector with elegant design and high reflection performance enabling efficient distribution of the light to the targeted area.

BALLAST

Electronic ballast with long life, low power loss EEI = A2 and constant flux. Compatible with ENEC standards.

CORPS

Corps couleur argent en aluminium anodisé et satiné . Design élégant.

REFLECTEUR

Reflecteur en aluminium enduit de peinture électrostatique. Design élégant. Assure une repartition efficace de la lumière vers l'endroit ciblé.

BALLAST

Ballast électronique a longue vie, perte de puissance réduite EEI = A2 et flux constant. Compatible avec les standards ENEC.

Kod Code	Güç Power Puissance (W)	Ampul Tipi Lamp Type Type De Lampe	Duy Tipi Socket Type Type De Douille	Işık Akısı Lum. Flux Flux Lum. (lm)	Akım Current Courant (A)	Ölçüler Dimensions (mm) a b h	Ağırlık Weight Poids (kg)	Ambalaj Adedi Packing Quantity Colisage	Adet/20" Konteyner Pcs./20" Conteneur	Resim No Drawing No Dessin No
P52U228K2	2x28	T16(T5)	G5	5200	0.26	98 1185 68	2.50	2	2960	1
P52U254K2	2x54	T16(T5)	G5	8900	0.50	98 1185 68	2.50	2	2960	
P52U235K2	2x35	T16(T5)	G5	6600	0.33	98 1485 68	3.15	2	2370	
P52U249K2	2x49	T16(T5)	G5	8600	0.49	98 1485 68	3.15	2	2370	
P52U280K2	2x80	T16(T5)	G5	12300	0.76	98 1485 68	3.30	2	2370	
P52U428K2	4x28	T16(T5)	G5	10400	0.52	98 2360 68	5.00	2	1490	2
P52U454K2	4x54	T16(T5)	G5	17800	1.00	98 2360 68	5.00	2	1490	
P52U435K2	4x35	T16(T5)	G5	13200	0.66	98 2960 68	6.30	2	1190	
P52U449K2	4x49	T16(T5)	G5	17200	1.98	98 2960 68	6.30	2	1190	
P52U480K2	4x80	T16(T5)	G5	24600	1.52	98 2960 68	6.60	2	1190	

V / Hz 220 - 240 / 50 - 60

P52U235K

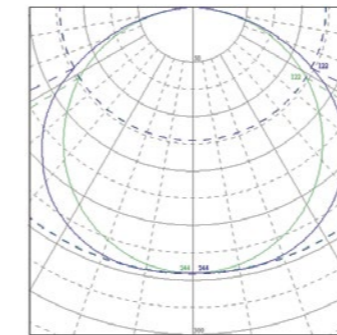

CO - C180
C90 - C270

Opsiyonlar Options Options

DIM edilebilir elektronik balast. Acil durum kit.
Dimmable electronic ballast. Emergency kit.
Ballast électronique dimmable. Kit d'urgence.

Askı: 1mm çelik örgü tel ve nikel kaplamalı pirinç parçalardan mamul, askı boyu ayarlanabilir, şeffaf elektrik kablosu ve tavana monte edilen, estetik tasarıma sahip elektrik bağlantı kutusu ile birlikte.
Suspension: Composed of 1mm steel wire rope and nickel-plated brass components. Suspension height is adjustable. Supplied with transparent electric cord and ceiling mounted electrical junction box with aesthetic design.
Fixation: Comprend un cable en acier de 1 mm et des composants en laiton nickelé. Livré avec un cordon électrique transparent, une boîte de jonction électrique au design esthétique, a fixer au plafond.

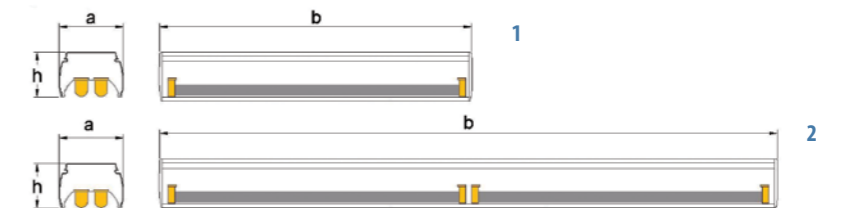



PROLINE



T16 (T5)

Sıva Üstü Tek Sıralı Alüminyum Reflektörlü Aydınlatma Armatürleri
Surface Mounted Single Line Lighting Fixtures With Aluminum Reflector
Luminaires Apparents 1X Avec Reflecteur Aluminium

UYGULAMA ALANLARI

Alışveriş Merkezleri
Marketler
Ofisler
Toplantı odaları
Mağazalar
Hastaneler
Okullar
Koridorlar

APPLICATION AREAS

Shopping Malls
Supermarkets
Offices
Meeting rooms
Stores
Hospitals
Schools
Corridors

DOMAINES D'UTILISATION

Centres Commerciaux
Supermarchés
Bureaux
Salles de Réunion
Magasins
Hopitaux
Ecoles
Coulloirs

GÖVDE

Gümüş renkli, zarif tasarıma sahip, saten eloksallı kaplamalı alüminyum.

REFLEKTÖR

%99,9 Saflıkta, ayna yüzeyi parlaklığında ve yüksek yansıtma performansına sahip ışığın verimli bir şekilde dağılımını sağlayan zarif tasarımlı eloksallı kaplamalı alüminyum.

BALAST

ENEC standartlarına uygun, uzun ömürlü sabit ışık akısına sahip, düşük enerji kayıplı (EEI=A2) elektronik balast

BODY

Anodized aluminum with satin finishing, elegant design with silver color.

REFLECTOR

Anodized aluminum with %99,9 purity and with mirror like glossy surface having high reflection performance. Elegant design enables the efficient distribution of the light to the targeted area.

BALLAST

Electronic ballast with long life, low power loss EEI = A2 and constant flux. Compatible with ENEC standards.

CORPS

Corps couleur argent en aluminium anodisé et satiné. Design élégant.

REFLECTEUR

En aluminium anodisé a 99,99% de pureté et avec une surface brillante comme un miroir, assurant un niveau élevé de reflection. Design élégant. Permet une répartition efficace de la lumière vers l'endroit ciblé.

BALLAST

Ballast électronique a longue vie, perte de puissance réduite EEI = A2 et flux constant. Compatible avec les standards ENEC.

Kod Code	Güç Power Puissance (W)	Ampul Tipi Lamp Type Type De Lampe	Duy Tipi Socket Type Type De Douille	Işık Akısı Lum. Flux Flux Lum. (lm)	Akım Current Courant (A)	Ölçüler Dimensions (mm) a b h	Ağırlık Weight Poids (kg)	Ambalaj Adedi Packing Quantity Colisage	Adet/20" Konteyner Pcs./20" Conteneur	Resim No Drawing No Dessin No
P52U128A	1x28	T16(T5)	G5	2600	0.14	98 1183 69	2.50	2	2960	1
P52U154A	1x54	T16(T5)	G5	4450	0.26	98 1183 69	2.50	2	2960	
P52U135A	1x35	T16(T5)	G5	3300	0.17	98 1483 69	3.04	2	2370	
P52U149A	1x49	T16(T5)	G5	4300	0.24	98 1483 69	3.04	2	2370	
P52U180A	1x80	T16(T5)	G5	6150	0.38	98 1483 69	3.04	2	2370	
P52U228A	2x28	T16(T5)	G5	5200	0.26	98 2356 69	4.76	2	1490	2
P52U254A	2x54	T16(T5)	G5	8900	0.50	98 2356 69	4.76	2	1490	
P52U235A	2x35	T16(T5)	G5	6600	0.33	98 2956 69	5.95	2	1190	
P52U249A	2x49	T16(T5)	G5	8600	0.49	98 2956 69	5.95	2	1190	
P52U280A	2x80	T16(T5)	G5	12300	0.76	98 2956 69	5.95	2	1190	

V / Hz 220 - 240 / 50 - 60

Opsiyonlar Options Options

DIM edilebilir elektronik balast. Acil durum kiti. Dimmable electronic ballast. Emergency kit. Ballast électronique dimmable. Kit d'urgence.



Askı: 1mm çelik örgü tel ve nikel kaplamalı pirinç parçalardan mamul, askı boyu ayarlanabilir, şeffaf elektrik kablosu ve tavana monte edilen, estetik tasarıma sahip elektrik bağlantı kutusu ile birlikte.

Suspension: Composed of 1mm steel wire rope and nickel-plated brass components. Suspension height is adjustable. Supplied with transparent electric cord and ceiling mounted electrical junction box with aesthetic design.

Fixation: Comprend un cable en acier de 1 mm et des composants en laiton nickelé. Livré avec un cordon électrique transparent, une boîte de jonction électrique au design esthétique, a fixer au plafond.

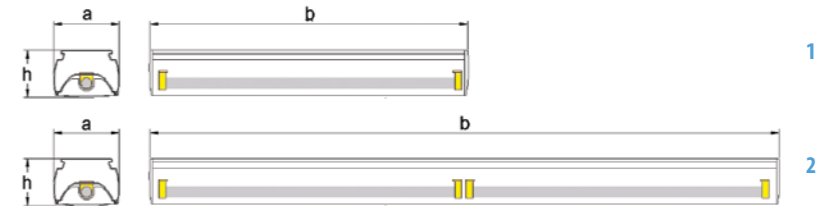



PROLINE

Renk Seçenekleri
Color Options
Options de Couleur



T16 (T5)

Sıva Altı Alüminyum Reflektörlü
Aydınlatma Armatürleri

Recessed Lighting Fixtures
With Aluminum Reflector

Luminaire Encastrés Avec
Reflecteur en Aluminium

UYGULAMA ALANLARI

Alışveriş Merkezleri
Marketler
Ofisler
Toplantı odaları
Mağazalar
Hastaneler
Okullar
Koridorlar

APPLICATION AREAS

Shopping Malls
Supermarkets
Offices
Meeting rooms
Stores
Hospitals
Schools
Corridors

DOMAINES D'UTILISATION

Centres Commerciaux
Supermarchés
Bureaux
Salles de Réunion
Magasins
Hopitaux
Ecoles
Couloirs

GÖVDE

Gümüş ve beyaz renkli, zarif tasarıma sahip, saten eloksallı alüminyum.

REFLEKTÖR

%99,9 Safılıkta, ayna yüzeyi parlaklığında ve yüksek yansıtma performansına sahip ışığın verimli bir şekilde dağılımını sağlayan zarif tasarımlı eloksallı alüminyum.

BALAST

ENEC standartlarına uygun, uzun ömürlü sabit ışık akısına sahip, düşük enerji kayıplı (EEI=A2) elektronik balast

BODY

Anodized aluminum with satin finishing, elegant design with silver and white color.

REFLECTOR

Anodized aluminum with %99,9 purity and with mirror like glossy surface having high reflection performance. Elegant design enables the efficient distribution of the light to the targeted area.

BALLAST

Electronic ballast with long life, low power loss EEI = A2 and constant flux. Compatible with ENEC standards.

CORPS

Corps couleur argent et blanc en aluminium anodisé et satiné. Design élégant.

REFLECTEUR

En aluminium anodisé a 99,99% de pureté et avec une surface brillante comme un miroir, assurant un niveau élevé de réflexion. Design élégant. Permet une répartition efficace de la lumière vers l'endroit ciblé.

BALLAST

Ballast électronique a longue vie, perte de puissance réduite EEI = A2 et flux constant. Compatible avec les standards ENEC.

Kod Code	Güç Power Puissance (W)	Ampul Tipi Lamp Type Type De Lampe	Duy Tipi Socket Type Type De Douille	Işık Akısı Lum. Flux Flux Lum. (lm)	Akım Current Courant (A)	Ölçüler Dimensions (mm) a b h	Ağırlık Weight Poids (kg)	Ambalaj Adedi Packing Quantity Colisage	Adet/20" Konteyner Pcs./20" Container Pcs./20" Conteneur	Resim No Drawing No Dessin No
P52A128A	1x28	T16(T5)	G5	2600	0.14	87 1178 66	2.85	2	3100	1
P52A154A	1x54	T16(T5)	G5	4450	0.26	87 1178 66	2.85	2	3100	
P52A135A	1x35	T16(T5)	G5	3300	0.17	87 1478 66	3.40	2	2470	
P52A149A	1x49	T16(T5)	G5	4300	0.24	87 1478 66	3.40	2	2470	
P52A180A	1x80	T16(T5)	G5	6150	0.38	87 1478 66	3.40	2	2470	2
P52A228A	2x28	T16(T5)	G5	5200	0.26	87 2351 66	4.90	2	1580	
P52A254A	2x54	T16(T5)	G5	8900	0.50	87 2351 66	4.90	2	1580	
P52A235A	2x35	T16(T5)	G5	6600	0.33	87 2951 66	6.10	2	1250	
P52A249A	2x49	T16(T5)	G5	8600	0.49	87 2951 66	6.10	2	1250	
P52A280A	2x80	T16(T5)	G5	12300	0.76	87 2951 66	6.10	2	1250	

V / Hz 220 - 240 / 50 - 60

Opsiyonlar	Options	Options
DIM edilebilir elektronik balast.	Dimmable electronic ballast.	Ballast électronique dimmable..

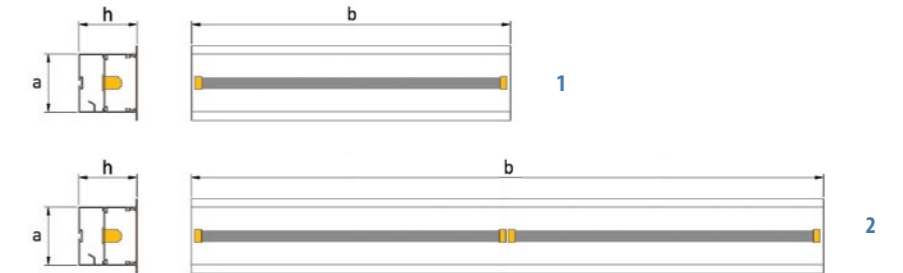



PROLINE

Renk Seçenekleri
Color Options
Options de Couleur



LED

Sıva Altı Difüzörlü Aydınlatma Armatürleri

Recessed Lighting Fixtures With Diffuser

Luminaire Encastrés Avec Diffuseur

UYGULAMA ALANLARI

Alışveriş Merkezleri
Marketler
Ofisler
Toplantı odaları
Mağazalar
Hastaneler
Okullar
Koridorlar

APPLICATION AREAS

Shopping Malls
Supermarkets
Offices
Meeting rooms
Stores
Hospitals
Schools
Corridors

DOMAINES D'UTILISATION

Centres Commerciaux
Supermarchés
Bureaux
Salles de Réunion
Magasins
Hopitaux
Ecoles
Couloirs

GÖVDE

Gümüş ve beyaz renkli, zarif tasarıma sahip, saten eloksallı kaplamalı alüminyum.

DİFÜZÖR

UV korumalı PC difüzör

KONVERTÖR

ENEC standartlarına uygun, uzun ömürlü sabit akımlı konvertör.

LED

50.000 saat ömürlü LUMILEDS / OSRAM / SEOUL marka LED'li LED modüller.

BODY

Anodized aluminum with satin finishing, elegant design with silver and white color.

DIFFUSER

UV stabilized PC diffuser.

CONVERTER

Long life, low power loss converter with constant current. Compatible with ENEC standards.

LED

LED modules with 50,000 hours lifetime LUMILEDS / OSRAM / SEOUL brand LEDs.

CORPS

Corps couleur argent et blanc en aluminium anodisé et satiné. Design élégant.

DIFFUSEUR

Diffuseur en PC anti UV.

CONVERTEUR

Convertisseur, conforme aux normes ENEC. Longue vie. Perte de puissance faible avec courant constant.

LED

Modules LED – Durée de vie 50.000 heures avec LED de marque LUMILEDS / OSRAM / SEOUL.

V / Hz	220 - 240 / 50 - 60
--------	---------------------

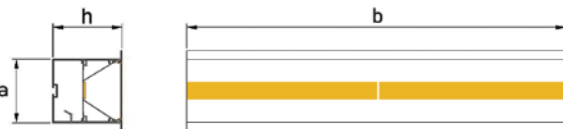

Opsiyonlar	Options	Options
DIM edilebilir konvertör.	Dimmable Converter.	Convertisseur dimmable.
Acil durum kiti.	Emergency kit.	Kit d'urgence.

Renk Geri Verim Indexi / Color Rendering Index / Indice de Rendu des Couleurs: (CRI): Ra>80

Kod Code	Güç Power Puissance (W)	LED Tipi LED Type Type De LED	LED Modül LED Module Module LED	Işık Akısı Lum. Flux Flux Lum. (lm)	Renk Sıcaklığı Color Temperature Température De Couleur (K)	Ölçüler Dimensions (mm)			Ağırlık Weight Poids (kg)	Ambalaj Adedi Packing Quantity Colisage	Adet/20" Konteyner Pcs./20" Container
						a	b	h			
PL2A12L15C	2x6,5	3535 SMD	PCB	1700	3000 / 4000 / 6500	85	573	85	1.1	2	6100
PL2A12L15CSB	2x6,5	3535 SMD	PCB	1700	3000 / 4000 / 6500	85	571	85	1.0	2	6100
PL2A12L15CSO	2x6,5	3535 SMD	PCB	1700	3000 / 4000 / 6500	85	570	85	0.9	2	6100
PL2A12L25C	2x12	3535 SMD	PCB	3100	3000 / 4000 / 6500	85	573	85	1.1	2	6100
PL2A12L25CSB	2x12	3535 SMD	PCB	3100	3000 / 4000 / 6500	85	571	85	1.0	2	6100
PL2A12L25CSO	2x12	3535 SMD	PCB	3100	3000 / 4000 / 6500	85	570	85	0.9	2	6100
PL2A13L15C	3x6,5	3535 SMD	PCB	2550	3000 / 4000 / 6500	85	861	85	1.7	2	4100
PL2A13L15CSB	3x6,5	3535 SMD	PCB	2550	3000 / 4000 / 6500	85	859	85	1.6	2	4100
PL2A13L15CSO	3x6,5	3535 SMD	PCB	2550	3000 / 4000 / 6500	85	858	85	1.5	2	4100
PL2A13L25C	3x12	3535 SMD	PCB	4650	3000 / 4000 / 6500	85	861	85	1.7	2	4100
PL2A13L25CSB	3x12	3535 SMD	PCB	4650	3000 / 4000 / 6500	85	859	85	1.6	2	4100
PL2A13L25CSO	3x12	3535 SMD	PCB	4650	3000 / 4000 / 6500	85	858	85	1.5	2	4100
PL2A14L15C	4x6,5	3535 SMD	PCB	3400	3000 / 4000 / 6500	85	1141	85	2.3	2	3100
PL2A14L15CSB	4x6,5	3535 SMD	PCB	3400	3000 / 4000 / 6500	85	1139	85	2.2	2	3100
PL2A14L15CSO	4x6,5	3535 SMD	PCB	3400	3000 / 4000 / 6500	85	1138	85	2.1	2	3100
PL2A14L25C	4x12	3535 SMD	PCB	6200	3000 / 4000 / 6500	85	1141	85	2.3	2	3100
PL2A14L25CSB	4x12	3535 SMD	PCB	6200	3000 / 4000 / 6500	85	1139	85	2.2	2	3100
PL2A14L25CSO	4x12	3535 SMD	PCB	6200	3000 / 4000 / 6500	85	1138	85	2.1	2	3100
PL2A15L15C	5x6,5	3535 SMD	PCB	4250	3000 / 4000 / 6500	85	1422	85	2.8	2	2470
PL2A15L15CSB	5x6,5	3535 SMD	PCB	4250	3000 / 4000 / 6500	85	1420	85	2.7	2	2470
PL2A15L15CSO	5x6,5	3535 SMD	PCB	4250	3000 / 4000 / 6500	85	1419	85	2.6	2	2470
PL2A15L25C	5x12	3535 SMD	PCB	7750	3000 / 4000 / 6500	85	1422	85	2.8	2	2470
PL2A15L25CSB	5x12	3535 SMD	PCB	7750	3000 / 4000 / 6500	85	1420	85	2.7	2	2470
PL2A15L25CSO	5x12	3535 SMD	PCB	7750	3000 / 4000 / 6500	85	1419	85	2.6	2	2470
PL2A16L15C	6x6,5	3535 SMD	PCB	5100	3000 / 4000 / 6500	85	1710	85	3.4	2	2060
PL2A16L15CSB	6x6,5	3535 SMD	PCB	5100	3000 / 4000 / 6500	85	1708	85	3.3	2	2060
PL2A16L15CSO	6x6,5	3535 SMD	PCB	5100	3000 / 4000 / 6500	85	1707	85	3.2	2	2060
PL2A16L25C	6x12	3535 SMD	PCB	9300	3000 / 4000 / 6500	85	1710	85	3.4	2	2060
PL2A16L25CSB	6x12	3535 SMD	PCB	9300	3000 / 4000 / 6500	85	1708	85	3.3	2	2060
PL2A16L25CSO	6x12	3535 SMD	PCB	9300	3000 / 4000 / 6500	85	1707	85	3.2	2	2060
PL2A17L15C	7x6,5	3535 SMD	PCB	5950	3000 / 4000 / 6500	85	1990	85	3.9	2	1760
PL2A17L15CSB	7x6,5	3535 SMD	PCB	5950	3000 / 4000 / 6500	85	1988	85	3.8	2	1760
PL2A17L15CSO	7x6,5	3535 SMD	PCB	5950	3000 / 4000 / 6500	85	1987	85	3.7	2	1760
PL2A18L15C	8x6,5	3535 SMD	PCB	6800	3000 / 4000 / 6500	85	2271	85	4.4	2	1540
PL2A18L15CSB	8x6,5	3535 SMD	PCB	6800	3000 / 4000 / 6500	85	2269	85	4.3	2	1540
PL2A18L15CSO	8x6,5	3535 SMD	PCB	6800	3000 / 4000 / 6500	85	2268	85	4.2	2	1540
PL2A19L15C	9x6,5	3535 SMD	PCB	7650	3000 / 4000 / 6500	85	2558	85	4.9	2	1360
PL2A19L15CSB	9x6,5	3535 SMD	PCB	7650	3000 / 4000 / 6500	85	2556	85	4.8	2	1360
PL2A19L15CSO	9x6,5	3535 SMD	PCB	7650	3000 / 4000 / 6500	85	2555	85	4.7	2	1360
PL2A10L15C	10x6,5	3535 SMD	PCB	8500	3000 / 4000 / 6500	85	2840	85	5.4	2	1220
PL2A10L15CSB	10x6,5	3535 SMD	PCB	8500	3000 / 4000 / 6500	85	2838	85	5.3	2	1220
PL2A10L15CSO	10x6,5	3535 SMD	PCB	8500	3000 / 4000 / 6500	85	2837	85	5.2	2	1220
PL2A11L15C	11x6,5	3535 SMD	PCB	9350	3000 / 4000 / 6500	85	3120	85	5.9	2	1110
PL2A11L15CSB	11x6,5	3535 SMD	PCB	9350	3000 / 4000 / 6500	85	3118	85	5.8	2	1110
PL2A11L15CSO	11x6,5	3535 SMD	PCB	9350	3000 / 4000 / 6500	85	3117	85	5.7	2	1110



PROLINE

T16 (T5)

Sıva Altı Tek Sıralı Difüzörlü
Aydınlatma Armatürleri

Recessed Single Line Lighting
Fixtures With Diffuser

Luminaires Encastrés Avec
Diffuseur - 1 ligne

UYGULAMA ALANLARI	APPLICATION AREAS	DOMAINES D'UTILISATION
Alışveriş Merkezleri Marketler Ofisler Toplantı odaları Mağazalar Hastaneler Okullar Koridorlar	Shopping Malls Supermarkets Offices Meeting rooms Stores Hospitals Schools Corridors	Centres Commerciaux Supermarchés Bureaux Salles de Réunion Magasins Hopitaux Ecoles Coulloirs

GÖVDE

Gümüş ve beyaz renkli, zarif tasarıma sahip, saten eloksallı alüminyum.

DİFÜZÖR

UV korumalı PC difüzör.

BALAST

ENEC standartlarına uygun, uzun ömürlü sabit ışık akısına sahip, düşük enerji kayıplı (EEI=A2) elektronik balast

BODY

Anodized aluminum with satin finishing, elegant design with silver and white color.

DIFFUSER

UV stabilized PC diffuser.

BALLAST

Electronic ballast with long life, low power loss EEI = A2 and constant flux. Compatible with ENEC standards.

CORPS

Corps couleur argent et blanc en aluminium anodisé et satiné. Design élégant.

DIFFUSEUR

Diffuseur en PC anti UV.

BALLAST

Ballast électronique a longue vie, perte de puissance réduite EEI = A2 et flux constant. Compatible avec les standards ENEC.



P52A135C

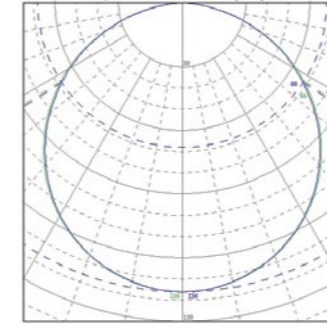

CO - C180
C90 - C270

Renk Seçenekleri
Color Options
Options de Couleur



Kod Code	Güç Power Puissance (W)	Ampul Tipi Lamp Type Type De Lampe	Duy Tipi Socket Type Type De Douille	Işık Akısı Lum. Flux Flux Lum. (lm)	Akım Current Courant (A)	Ölçüler Dimensions (mm)			Ağırlık Weight Poids (kg)	Ambalaj Adedi Packing Quantity Colisage	Adet/20" Konteyner Pcs./20" Container Pcs./20" Conteneur	Resim No Drawing No Dessin No
						a	b	h				
P52A114C	1x14	T16(T5)	G5	1200	0.08	85	578	85	1.20	2	6300	1
P52A114CSB	1x14	T16(T5)	G5	1200	0.08	85	513	85	1.20	2	6300	
P52A114CSO	1x14	T16(T5)	G5	1200	0.08	85	448	85	1.20	2	6300	
P52A124C	1x24	T16(T5)	G5	1750	0.12	85	578	85	1.20	2	6300	
P52A124CSB	1x24	T16(T5)	G5	1750	0.12	85	513	85	1.20	2	6300	
P52A124CSO	1x24	T16(T5)	G5	1750	0.12	85	448	85	1.20	2	6300	
P52A121C	1x21	T16(T5)	G5	1900	0.11	85	878	85	1.80	2	4150	
P52A121CSB	1x21	T16(T5)	G5	1900	0.11	85	813	85	1.80	2	4150	
P52A121CSO	1x21	T16(T5)	G5	1900	0.11	85	748	85	1.80	2	4150	
P52A128C	1x28	T16(T5)	G5	2600	0.14	85	1178	85	2.40	2	3100	
P52A128CSB	1x28	T16(T5)	G5	2600	0.14	85	1113	85	2.30	2	3100	
P52A128CSO	1x28	T16(T5)	G5	2600	0.14	85	1048	85	2.20	2	3100	
P52A154C	1x54	T16(T5)	G5	4450	0.26	85	1178	85	2.40	2	3100	
P52A154CSB	1x54	T16(T5)	G5	4450	0.26	85	1113	85	2.30	2	3100	
P52A154CSO	1x54	T16(T5)	G5	4450	0.26	85	1048	85	2.20	2	3100	
P52A135C	1x35	T16(T5)	G5	3300	0.17	85	1478	85	3.00	2	2470	
P52A135CSB	1x35	T16(T5)	G5	3300	0.17	85	1413	85	2.90	2	2470	
P52A135CSO	1x35	T16(T5)	G5	3300	0.17	85	1348	85	2.80	2	2470	
P52A149C	1x49	T16(T5)	G5	4300	0.24	85	1478	85	3.00	2	2470	
P52A149CSB	1x49	T16(T5)	G5	4300	0.24	85	1413	85	2.90	2	2470	
P52A149CSO	1x49	T16(T5)	G5	4300	0.24	85	1348	85	2.80	2	2470	
P52A180C	1x80	T16(T5)	G5	6150	0.38	85	1478	85	3.00	2	2470	
P52A180CSB	1x80	T16(T5)	G5	6150	0.38	85	1413	85	2.90	2	2470	
P52A180CSO	1x80	T16(T5)	G5	6150	0.38	85	1348	85	2.80	2	2470	
P52A228C	2x28	T16(T5)	G5	5200	0.26	85	2226	85	4.80	2	1580	
P52A228CSB	2x28	T16(T5)	G5	5200	0.26	85	2161	85	4.70	2	1580	
P52A228CSO	2x28	T16(T5)	G5	5200	0.26	85	2096	85	4.50	2	1580	
P52A254C	2x54	T16(T5)	G5	8900	0.50	85	2226	85	4.80	2	1580	
P52A254CSB	2x54	T16(T5)	G5	8900	0.50	85	2161	85	4.70	2	1580	
P52A254CSO	2x54	T16(T5)	G5	8900	0.50	85	2096	85	4.50	2	1580	
P52A235C	2x35	T16(T5)	G5	6600	0.33	85	2826	85	5.90	2	1250	
P52A235CSB	2x35	T16(T5)	G5	6600	0.33	85	2761	85	5.70	2	1250	
P52A235CSO	2x35	T16(T5)	G5	6600	0.33	85	2696	85	5.60	2	1250	
P52A249C	2x49	T16(T5)	G5	8600	0.49	85	2826	85	5.90	2	1250	
P52A249CSB	2x49	T16(T5)	G5	8600	0.49	85	2761	85	5.70	2	1250	
P52A249CSO	2x49	T16(T5)	G5	8600	0.49	85	2696	85	5.60	2	1250	
P52A280C	2x80	T16(T5)	G5	12300	0.76	85	2826	85	5.90	2	1250	
P52A280CSB	2x80	T16(T5)	G5	12300	0.76	85	2761	85	5.70	2	1250	
P52A280CSO	2x80	T16(T5)	G5	12300	0.76	85	2696	85	5.60	2	1250	

V / Hz 220 - 240 / 50 - 60

Opsiyonlar	Options	Options
DIM edilebilir elektronik balast. Acil durum kit.	Dimmable electronic ballast. Emergency kit.	Ballast électronique dimmable. Kit d'urgence.

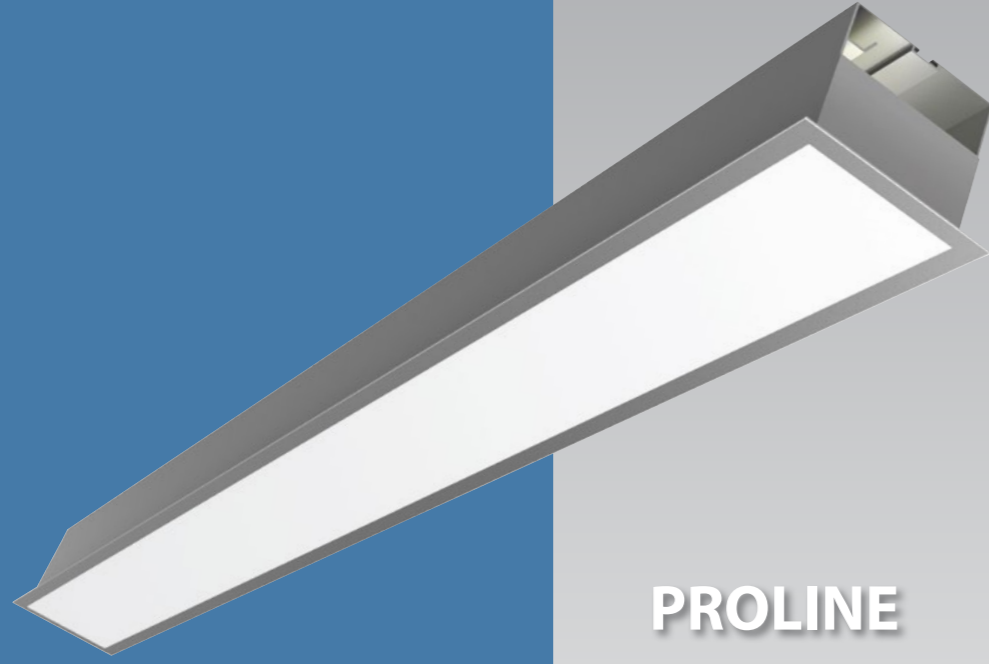

PROLINE

Renk Seçenekleri
Color Options
Options de Couleur



T16 (T5)

Sıva Altı Çift Sıralı Difüzörlü Aydınlatma Armatürleri

Recessed Double Line Lighting Fixtures With Diffuser

Luminaire Encastrés Avec Diffuseur - 2 Lignes

UYGULAMA ALANLARI

Alışveriş Merkezleri
Marketler
Ofisler
Toplantı odaları
Mağazalar
Hastaneler
Okullar
Koridorlar

APPLICATION AREAS

Shopping Malls
Supermarkets
Offices
Meeting rooms
Stores
Hospitals
Schools
Corridors

DOMAINES D'UTILISATION

Centres Commerciaux
Supermarchés
Bureaux
Salles de Réunion
Magasins
Hopitaux
Ecoles
Couloirs

GÖVDE

Gümüş ve beyaz renkli, zarif tasarıma sahip, saten eloksallı alüminyum.

DİFÜZÖR

UV korumalı PC difüzör.

BALAST

ENEC standartlarına uygun, uzun ömürlü sabit ışık akısına sahip, düşük enerji kayıplı (EEI=A2) elektronik balast.

BODY

Anodized aluminum with satin finishing, elegant design with silver and white color.

DIFFUSEUR

UV stabilized PC diffuser.

BALLAST

Electronic ballast with long life, low power loss EEI = A2 and constant flux. Compatible with ENEC standards.

CORPS

Corps couleur argent et blanc en aluminium anodisé et satiné. Design élégant.

DIFFUSEUR

Diffuseur en PC anti UV.

BALLAST

Ballast électronique a longue vie, perte de puissance réduite EEI = A2 et flux constant. Compatible avec les standards ENEC.

Kod Code	Güç Power Puissance (W)	Ampul Tipi Lamp Type Type De Lampe	Duy Tipi Socket Type Type De Douille	Işık Akısı Lum. Flux Flux Lum. (lm)	Akım Current Courant (A)	Ölçüler Dimensions (mm)			Ağırlık Weight Poids (kg)	Ambalaj Adedi Packing Quantity Colisage	Adet/20" Konteyner Pcs./20" Container Pcs./20" Conteneur
						a	b	h			
P52A228C2	2x28	T16(T5)	G5	5200	0.26	85	1178	85	4.60	2	3100
P52A254C2	2x54	T16(T5)	G5	8900	0.50	85	1178	85	4.60	2	3100
P52A235C2	2x35	T16(T5)	G5	6600	0.33	85	1478	85	5.70	2	2470
P52A249C2	2x49	T16(T5)	G5	8600	0.49	85	1478	85	5.70	2	2470
P52A280C2	2x80	T16(T5)	G5	12300	0.76	85	1478	85	5.70	2	2470

V / Hz 220 - 240 / 50 - 60

Opsiyonlar	Options	Options
DIM edilebilir elektronik balast.	Dimmable electronic ballast.	Ballast électronique dimmable.
Acil durum kiti.	Emergency kit.	Kit d'urgence.

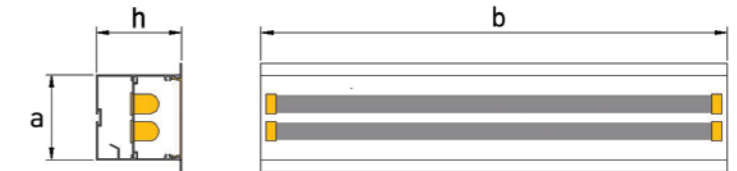



BANT / BATTEN / RÉGLETTES

T26 (T8)

Sıva Üstü Bant Tipi

Aydınlatma Armatürleri

Surface Mounted Batten Type

Lighting Fixtures

Luminaire Apparents

Réglettes

UYGULAMA ALANLARI

Alışveriş Merkezleri
Marketler
Ofisler
Toplantı odaları
Mağazalar
Hastaneler
Okullar
Koridorlar

APPLICATION AREAS

Shopping Malls
Supermarkets
Offices
Meeting rooms
Stores
Hospitals
Schools
Corridors

DOMAINES D'UTILISATION

Centres Commerciaux
Supermarchés
Bureaux
Salles de Réunion
Magasins
Hopitaux
Ecoles
Coulors

GÖVDE

RAL 9016 elektrostatik toz boyalı DKP sac.

BALAST

ENEC standartlarına uygun, uzun ömürlü sabit ışık akısına sahip, düşük enerji kayıplı (EEI=A2) elektronik balast

BODY

RAL 9016 electrostatic powder coated sheet metal.

BALLAST

Electronic ballast with long life, low power loss EEI = A2 and constant flux. Compatible with ENEC standards.

CORPS

RAL 9016 Feuille de métal peinte électrostatiquement .

BALLAST

Ballast électronique. Conforme aux normes ENEC. Longue vie. Perte de puissance faible (EEI=A2). Flux de lumière régulier.

Elektronik Balastlı / With Electronic Ballast / Avec Ballast Electronique

Kod Code	Güç Power Puissance (W)	Ampul Tipi Lamp Type Type De Lampe	Duy Tipi Socket Type Type De Douille	Işık Akısı Lum. Flux Flux Lum. (lm)	Akım Current Courant (A)	Ölçüler Dimensions (mm) a l h			Ağırlık Weight Poids (kg)	Ambalaj Adedi Packing Quantity Colisage	Adet/20" Konteyner Pcs./20" Container Pcs./20" Conteneur
P810U118C	1x18	T26(T8)	G13	1350	0,09	58	610	43	0,53	6	17000
P810U136C	1x36	T26(T8)	G13	3250	0,16	58	1220	43	0,93	6	8500
P810U158C	1x58	T26(T8)	G13	5200	0,24	58	1520	43	1,33	6	6800
P810U218C	2x18	T26(T8)	G13	2700	0,16	58	610	43	0,58	6	17000
P810U236C	2x36	T26(T8)	G13	6500	0,32	58	1220	43	0,98	6	8500
P810U258C	2x58	T26(T8)	G13	10400	0,48	58	1520	43	1,38	6	6800

Led Tüp Tesisatlı / With Led Tube Wiring / Avec Cablage Led Tube

Kod Code	Ampul Tipi Lamp Type Type De Lampe	Duy Tipi Socket Type Type De Douille	Ölçüler Dimensions (mm) a l h			Ağırlık Weight Poids (kg)	Ambalaj Adedi Packing Quantity Colisage	Adet/20" Konteyner Pcs./20" Container Pcs./20" Conteneur
P810U118LD	T26(T8)	G13	58	610	43	0,45	6	17000
P810U218LD	T26(T8)	G13	58	610	43	0,45	6	17000
P810U136LD	T26(T8)	G13	58	1220	43	0,85	6	8500
P810U236LD	T26(T8)	G13	58	1220	43	0,85	6	8500

V / Hz 220 - 240 / 50 - 60

Opsiyonlar	Options	Options
DIM edilebilir elektronik balast. Acil durum kiti.	Dimmable electronic ballast. Emergency kit.	Ballast électronique dimmable. Kit d'urgence.
Askı: 1mm çelik örgü tel ve nikel kaplamalı pirinç parçalardan mamul, askı boyu ayarlanabilir, şeffaf elektrik kablosu ve tavana monte edilen, estetik tasarıma sahip elektrik bağlantı kutusu ile birlikte.	Suspension: Composed of 1mm steel wire rope and nickel-plated brass components. Suspension height is adjustable. Supplied with transparent electric cord and ceiling mounted electrical junction box with aesthetic design.	Fixation: Comprend un cable en acier de 1 mm et des composants en laiton nickelé. Livré avec un cordon électrique transparent, une boîte de jonction électrique au design esthétique, a fixer au plafond.





 **pamir**[®]
aydınlık

WALL WASHER





WALL WASHER



LED

Aydınlatma Armatürleri

Lighting Fixtures

Luminaire

UYGULAMA ALANLARI	APPLICATION AREAS	DOMAINES D'UTILISATION
Açık Alanlar Tüneller	Outdoor Areas Tunnels	Espaces Extérieurs Tunnels

GÖVDE

Gümüş renkli, zarif tasarıma sahip, saten elok-sal kaplamalı alüminyum.

CAM

Temperli cam.

KONVERTÖR

ENEC standartlarına uygun, uzun ömürlü sabit akımlı konvertör.

LED

50.000 saat ömürlü LED modüller.

BODY

Anodized aluminum with satin finishing, elegant design with silver color.

GLASS

Tempered glass.

CONVERTER

Long life, low power loss converter with constant current. Compatible with ENEC standards.

LED

LED modules with 50,000 hours lifetime.

CORPS

Corps en aluminium anodisé, satiné. Design Elegant Couleur Argent.

VERRE

Verre trempé.

CONVERTEUR

Convertisseur, conforme aux normes ENEC. Longue vie. Perte de puissance faible avec courant constant.

LED

Modules LED – Durée de vie 50.000 heures.

Kod Code	Güç Power Puissance (W)	Ölçüler Dimensions (mm)			Ağırlık Weight Poids (kg)	Ambalaj Adedi Packing Quantity Colisage	Adet/20" Konteyner Pcs./20" Container Pcs./20" Conteneur
		a	l	h			
PWU3C	3x1	50	120	70	0,4	2	56240
PWU6C	6x1	50	190	70	0,6	2	36050
PWU9C	9x1	50	270	70	0,8	2	25560
PWU12C	12x1	50	350	70	1,1	2	19800
PWU18C	18x1	50	500	70	1,4	2	13920
PWU24C	24x1	50	650	70	1,7	2	10730
PWU30C	30x1	50	750	70	2,0	2	9310
PWU36C	36x1	50	1000	70	2,3	2	7000
PWU48C	48x1	50	1300	70	2,7	2	5390



V / Hz 220 - 240 / 50 - 60

Opsiyonlar / Options

Işık Renk Seçenekleri Light Color Options Options de Couleur Lumière	<input type="checkbox"/> 6500 K <input type="checkbox"/> 4000 K <input type="checkbox"/> 3000 K <input type="checkbox"/> Amber Ambre <input type="checkbox"/> Yeşil Green Vert <input type="checkbox"/> Kırmızı Red Rouge <input type="checkbox"/> Mavi Blue Bleu
Işık Hüzmeleri Beam Angles Angles de Faisceau	10°, 20°, 30°, 45°, 60°, 80°, 100°



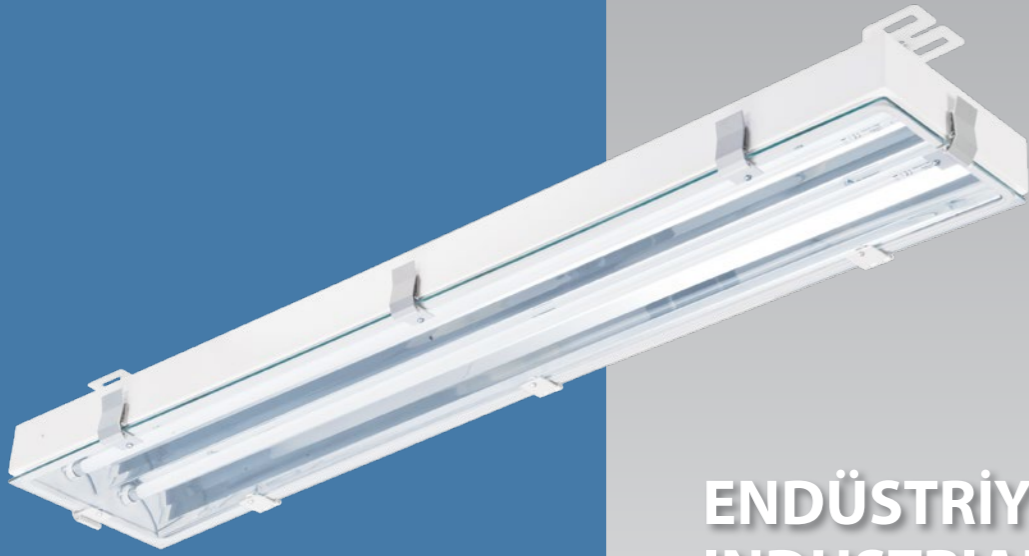

ENDÜSTRİYEL INDUSTRIAL INDUSTRIEL



LED / T16 (T5)

2X Yüksek Tavan

Aydınlatma Armatürleri

2X High Bay Lighting Fixtures

Luminaire Grande Hauteur 2X

UYGULAMA ALANLARI

Fabrikalar
Marketler
Depolar
Terminaller
Metrolar ve Tüneller
Spor Salonları
Kapalı Yüzme Havuzları

APPLICATION AREAS

Factories
Supermarkets
Warehouses
Stations
Subways and Tunnels
Sport Halls
Indoor Swimming
Pools

DOMAINES D'UTILISATION

Usines
Supermarchés
Hangars de stockage
Gares
Tunnels - Métros
Complexes sportifs
Piscines couvertes

GÖVDE

RAL 9016 elektrostatik toz boyalı DKP sac.

CAM

4mm temperli cam (kalite belgeli).

REFLEKTÖR

%99,9 Safılıkta, ayna yüzeyi parlaklığında ve yüksek yansıtma performansına ve ışığın verimli bir şekilde dağılımını sağlayan tasarıma sahip eloksallı kaplamalı alüminyum.

BALAST (T5 Modeller için)

ENEC standartlarına uygun, uzun ömürlü sabit ışık akısına sahip, düşük enerji kayıplı (EEI=A2) elektronik balast.

KONVERTÖR (LED'li Modeller için)

ENEC standartlarına uygun, uzun ömürlü sabit akımlı konvertör.

LED (LED'li Modeller için)

50.000 saat ömürlü LUMILEDS / OSRAM / SEOUL marka LED'li LED modülleri.

CONTA

Elastomer termoplastik.

CAM TUTUCULAR

Alüminyum.

BODY

RAL 9016 electrostatic powder coated sheet-metal.

GLASS

4mm tempered glass (with certificate).

REFLECTOR

Anodized aluminum with %99,9 purity and with mirror like glossy surface having high reflection performance and design enabling the efficient distribution of the light to the targeted area.

BALLAST (For T5 Models)

Electronic ballast with long life, low power loss EEI = A2 and constant flux. Compatible with ENEC standards.

CONVERTER (For LED Models)

Long life, low power loss converter with constant current. Compatible with ENEC standards.

LED (For LED Models)

LED modules with 50,000 hours lifetime LUMILEDS / OSRAM / SEOUL brand LEDs.

SEAL

Thermoplastic elastomer.

GLASS HOLDER LATCHES

Aluminium.

CORPS

RAL 9016 Feuille de métal peinte électrostatiquement.

VERRE

4 mm verre trempé (avec certificat).

REFLECTEUR

En aluminium anodisé à 99,99% de pureté et avec une surface brillante comme un miroir, assurant un niveau élevé de réflexion. Design élégant. Permet une répartition efficace de la lumière vers l'endroit ciblé.

BALLAST (Pour T5 Modèles)

Ballast électronique, conforme aux normes ENEC. Longue vie. Perte de puissance faible (EEI=A2). Flux de lumière régulier.

CONVERTEUR (Pour Modèles LED)

Convertisseur, conforme aux normes ENEC. Longue vie. Perte de puissance faible avec courant constant.

LED (Pour Modèles LED)

Modules LED – Durée de vie 50.000 heures avec LED de marque LUMILEDS / OSRAM / SEOUL.

JOINT

Elastomère thermoplastique.

CLAPETS DE MAINTIEN DU VERRE

Aluminium.

LED'li Tip / LED Type / Type LED

Renk Geri Verim Indexi / Color Rendering Index / Indice de Rendu des Couleurs: (CRI): Ra>80

Kod Code	Güç Power Puissance (W)	LED Tipi LED Type Type De LED	LED Modül LED Module Module LED	Işık Akısı Lum. Flux Flux Lum. (lm)	Renk Sıcaklığı Color Temperature Température De Couleur (K)	Ölçüler Dimensions (mm) a b h	Ağırlık Weight Poids (kg)	Ambalaj Adedi Packing Quantity Colisage	Adet/20 Konteyner Pcs./20 Container Pcs./20 Conteneur
EAL1U24L25C	8x12	3535 SMD	PCB	12400	3000 / 4000 / 6500	225 1200 70	7.5	1	900
EAL1U25L25C	10x12	3535 SMD	PCB	15500	3000 / 4000 / 6500	225 1500 70	9.0	1	730

T5 Floresanlı Tip / T5 Fluorescent Type / Type T5 Fluorescent

Kod Code	Güç Power Puissance (W)	Ampul Tipi Lamp Type Type De Lampe	Duy Tipi Socket Type Type De Douille	Işık Akısı Lum. Flux Flux Lum. (lm)	Akım Current Courant (A)	Ölçüler Dimensions (mm) a b h	Ağırlık Weight Poids (kg)	Ambalaj Adedi Packing Quantity Colisage	Adet/20 Konteyner Pcs./20 Container Pcs./20 Conteneur
EA51U254C	2x54	T16(T5)	G5	8900	0.50	225 1200 70	7.5	1	900
EA51U280C	2x80	T16(T5)	G5	12300	0.76	225 1500 70	9.0	1	730

V / Hz 220 - 240 / 50 - 60

Opsiyonlar	Options	Options
DIM edilebilir elektronik balast ya da konvertör.	Dimmable electronic ballast or converter.	Ballast électronique dimmable ou converteur.
Acil durum kiti.	Emergency kit.	Kit d'urgence.

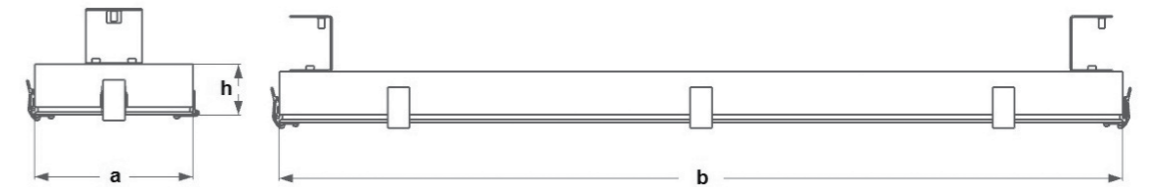

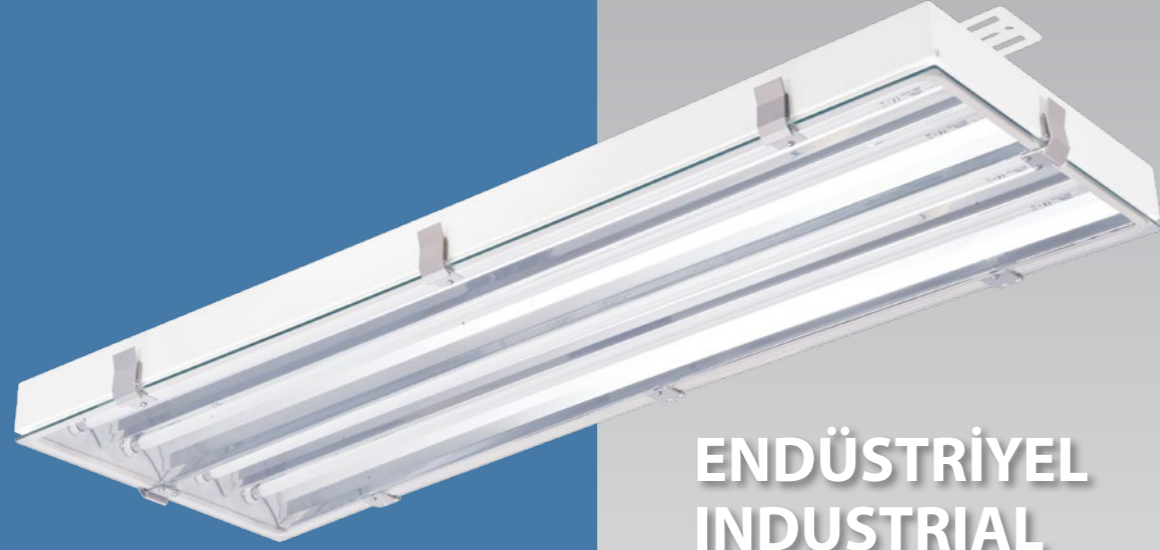

ENDÜSTRİYEL INDUSTRIAL INDUSTRIEL

LED / T16 (T5)

4X Yüksek Tavan
Aydınlatma Armatürleri

4X High Bay Lighting Fixtures

Luminaire Grande Hauteur 4X

UYGULAMA ALANLARI

Fabrikalar
Marketler
Depolar
Terminaller
Metrolar ve Tüneller
Spor Salonları
Kapalı Yüzme Havuzları

APPLICATION AREAS

Factories
Supermarkets
Warehouses
Stations
Subways and Tunnels
Sport Halls
Indoor Swimming
Pools

DOMAINES D'UTILISATION

Usines
Supermarchés
Hangars de stockage
Gares
Tunnels - Métros
Complexes sportifs
Piscines couvertes

GÖVDE

RAL 9016 elektrostatik toz boyalı DKP sac.

CAM

4mm temperli cam (kalite belgeli).

REFLEKTÖR

%99,9 Safılıkta, ayna yüzeyi parlaklığında ve yüksek yansıtma performansına ve ışığın verimli bir şekilde dağılımını sağlayan tasarıma sahip eloksallı kaplamalı alüminyum.

BALAST (T5 Modeller İçin)

ENEC standartlarına uygun, uzun ömürlü sabit ışık akısına sahip, düşük enerji kayıplı (EEI=A2) elektronik balast.

KONVERTÖR (LED'li Modeller İçin)

ENEC standartlarına uygun, uzun ömürlü sabit akımlı konvertör.

LED (LED'li Modeller İçin)

50.000 saat ömürlü LUMILEDS / OSRAM / SEOUL marka LED'li LED modülleri.

CONTA

Elastomer termoplastik.

CAM TUTUCULAR

Alüminyum.

BODY

RAL 9016 electrostatic powder coated sheet-metal.

GLASS

4mm tempered glass (with certificate).

REFLECTOR

Anodized aluminum with %99,9 purity and with mirror like glossy surface having high reflection performance and design enabling the efficient distribution of the light to the targeted area.

BALLAST (For T5 Models)

Electronic ballast with long life, low power loss EEI = A2 and constant flux. Compatible with ENEC standards.

CONVERTER (For LED Models)

Long life, low power loss converter with constant current. Compatible with ENEC standards.

LED (For LED Models)

LED modules with 50,000 hours lifetime LUMILEDS / OSRAM / SEOUL brand LEDs.

SEAL

Thermoplastic elastomer.

GLASS HOLDER LATCHES

Aluminium.

CORPS

RAL 9016 Feuille de métal peinte électrostatiquement.

VERRE

4 mm verre trempé (avec certificat).

REFLECTEUR

En aluminium anodisé à 99,99% de pureté et avec une surface brillante comme un miroir, assurant un niveau élevé de réflexion. Design élégant. Permet une répartition efficace de la lumière vers l'endroit ciblé.

BALLAST (Pour T5 Modèles)

Ballast électronique, conforme aux normes ENEC. Longue vie. Perte de puissance faible (EEI=A2). Flux de lumière régulier.

CONVERTEUR (Pour Modèles LED)

Convertisseur, conforme aux normes ENEC. Longue vie. Perte de puissance faible avec courant constant.

LED (Pour Modèles LED)

Modules LED - Durée de vie 50.000 heures avec LED de marque LUMILEDS / OSRAM / SEOUL.

JOINT

Elastomère thermoplastique.

CLAPETS DE MAINTIEN DU VERRE

Aluminium.

LED'li Tip / LED Type / Type LED

Renk Geri Verim Indexi / Color Rendering Index / Indice de Rendu des Couleurs: (CRI): Ra>80

Kod Code	Güç Power Puissance (W)	LED Tipi LED Type Type De LED	LED Modül LED Module Module LED	Işık Akısı Lum. Flux Flux Lum. (lm)	Renk Sıcaklığı Color Temperature Température De Couleur (K)	Ölçüler Dimensions (mm) a b h	Ağırlık Weight Poids (kg)	Ambalaj Adedi Packing Quantity Colisage	Adet/20" Konteyner Pcs./20" Container Pcs./20" Conteneur
EAL1U44L25C	16x12	3535 SMD	PCB	24800	3000 / 4000 / 6500	415 1200 70	12.1	1	540
EAL1U45L25C	20x12	3535 SMD	PCB	31000	3000 / 4000 / 6500	415 1500 70	15.1	1	430

T5 Floresanlı Tip / T5 Fluorescent Type / Type T5 Fluorescent

Kod Code	Güç Power Puissance (W)	Ampul Tipi Lamp Type Type De Lampe	Duy Tipi Socket Type Type De Douille	Işık Akısı Lum. Flux Flux Lum. (lm)	Akım Current Courant (A)	Ölçüler Dimensions (mm) a b h	Ağırlık Weight Poids (kg)	Ambalaj Adedi Packing Quantity Colisage	Adet/20" Konteyner Pcs./20" Container Pcs./20" Conteneur
EA51U454C	4x54	T16(T5)	G5	17800	1.00	415 1200 70	12.1	1	540
EA51U480C	4x80	T16(T5)	G5	24600	1.52	415 1500 70	15.1	1	430

V / Hz 220 - 240 / 50 - 60

Opsiyonlar	Options	Options
DIM edilebilir elektronik balast ya da konvertör.	Dimmable electronic ballast or converter.	Ballast électronique dimmable ou converteur.
Acil durum kiti.	Emergency kit.	Kit d'urgence.

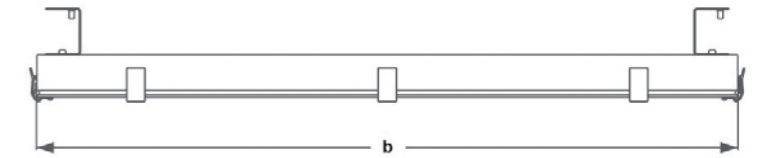
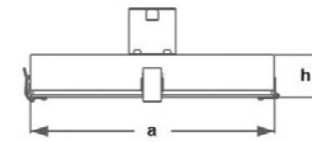



 **pamir**[®]
aydınlık

ETANJ / WATERPROOF / ETANCHE



ETANJ WATERPROOF ETANCHE

LED / T16 (T5)

1X Etanj Aydınlatma Armatürleri

1X Waterproof Lighting Fixtures

Luminaire Etanches 1X

UYGULAMA ALANLARI

Fabrikalar
Endüstriyel Mutfaklar
Çamaşırhaneler
Otoparklar
Açık Alanlar
Tüneller

APPLICATION AREAS

Factories
Industrial Kitchens
Laundries
Parking Areas
Outdoor Areas
Tunnels

DOMAINES D'UTILISATION

Usines
Cuisines Industrielles
Blanchisseries
Parkings
Espaces Extérieurs
Tunnels

GÖVDE

Polikarbon veya ABS gri renkli gövde ve polikarbon kilitlenme mandalları.

DİFÜZÖR

Yüksek ışık geçirgenliğine sahip polikarbon difüzör.

ASKI SACI

0.5 mm kalınlığında paslanmaz çelik sac.

REFLEKTÖR

Beyaz elektrostatik toz boyalı, 0.5 mm DKP sac.

BALAST (T5 Modeller İçin)

ENEC standartlarına uygun, uzun ömürlü sabit ışık akısına sahip, düşük enerji kayıplı (EEI=A2) elektronik balast.

KONVERTÖR (LED'li Modeller İçin)

ENEC standartlarına uygun, uzun ömürlü sabit akımlı konvertör.

LED (LED'li Modeller İçin)

50.000 saat ömürlü LUMILEDS / OSRAM / SEOUL marka LED'li LED modüller.

BODY

Polycarbonate or ABS body of gray color with polycarbonate diffuser holder.

DIFFUSER

Polycarbonate diffuser with high light transparency.

CEILING FIXING BRACE

Stainless steel sheet metal with 0.5 mm thickness.

REFLECTOR

White electrostatic powder coated, sheet metal with 0.5 mm thickness.

BALLAST (For T5 Models)

Electronic ballast with long life, low power loss EEI = A2 and constant flux. Compatible with ENEC standards.

CONVERTER (For LED Models)

Long life, low power loss converter with constant current. Compatible with ENEC standards.

LED (For LED Models)

LED modules with 50,000 hours lifetime LUMILEDS / OSRAM / SEOUL brand LEDs.

CORPS

Corps gris en Polycarbonate ou ABS avec porteur du diffuseur en polycarbonate.

DIFFUSEUR

En polycarbonate. Permet une tres grande diffusion de la lumière.

ACCOLADE DE FIXATION AU PLAFOND

Feuille d'acier inoxydable de 0.5 mm d'épaisseur.

REFLECTEUR

Feuille métallique de 0.5 mm d'épaisseur et peinte en blanc électrostatiquement.

BALLAST (Pour T5 Modèles)

Ballast électronique, conforme aux normes ENEC. Longue vie. Perte de puissance faible (EEI = A2). Flux de lumière régulier.

CONVERTEUR (Pour Modèles LED)

Convertisseur, conforme aux normes ENEC. Longue vie. Perte de puissance faible avec courant constant.

LED (Pour Modèles LED)

Modules LED - Durée de vie 50.000 heures avec LED de marque LUMILEDS / OSRAM / SEOUL.

LED'li Tip / LED Type / Type LED

Renk Geri Verim Indexi / Color Rendering Index / Indice de Rendu des Couleurs: (CRI): Ra>80

Kod Code	Güç Power Puissance (W)	LED Tipi LED Type Type De LED	LED Modül LED Module Module LED	Işık Akısı Lum. Flux Flux Lum. (lm)	Renk Sıcaklığı Color Temperature Température De Couleur (K)	Ölçüler Dimensions (mm) a b h	Ağırlık Weight Poids (kg)	Ambalaj Adedi Packing Quantity Colisage	Adet/20" Konteyner Pcs./20" Container Pcs./20" Conteneur
EAL12L15C	2x6,5	3535 SMD	PCB	1700	3000 / 4000 / 6500	670 95 102	1.2	9	4230
EAL14L15C	4x6,5	3535 SMD	PCB	3400	3000 / 4000 / 6500	1280 95 102	2.2	6	2250
EAL15L15C	5x6,5	3535 SMD	PCB	4250	3000 / 4000 / 6500	1570 95 102	2.6	6	1710

T5 Floresanlı Tip / T5 Fluorescent Type / Type T5 Fluorescent

Kod Code	Güç Power Puissance (W)	Ampul Tipi Lamp Type Type De Lampe	Duy Tipi Socket Type Type De Douille	Işık Akısı Lum. Flux Flux Lum. (lm)	Akım Current Courant (A)	Ölçüler Dimensions (mm) a b h	Ağırlık Weight Poids (kg)	Ambalaj Adedi Packing Quantity Colisage	Adet/20" Konteyner Pcs./20" Container Pcs./20" Conteneur
EAEB 128	1x28	T16(T5)	G5	2600	0.14	1280 95 102	1.70	9	2250
EAEB 154	1x54	T16(T5)	G5	4450	0.26	1280 95 102	1.70	9	2250
EAEB 135	1x35	T16(T5)	G5	3300	0.17	1570 95 102	2.05	6	1710
EAEB 149	1x49	T16(T5)	G5	4300	0.24	1570 95 102	2.05	6	1710
EAEB 180	1x80	T16(T5)	G5	6150	0.38	1570 95 102	2.05	6	1710

Opsiyonlar	Options	Options
DIM edilebilir elektronik balast ya da konvertör.	Dimmable electronic ballast or converter.	Ballast électronique dimmable ou converteur.
Acil durum kiti.	Emergency kit.	Kit d'urgence.

V / Hz 220 - 240 / 50 - 60

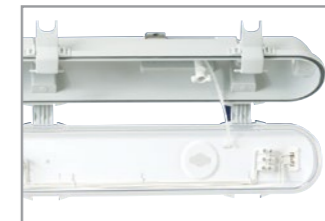
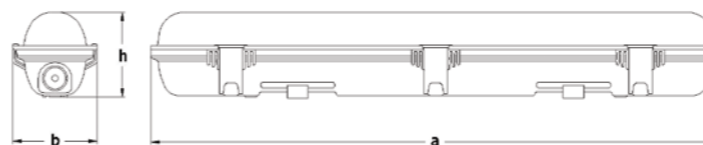

ETANJ WATERPROOF ETANCHE

LED / T16 (T5)

2X Etanj Aydınlatma Armatürleri

2X Waterproof Lighting Fixtures

Luminaire Etanches 2X

UYGULAMA ALANLARI

Fabrikalar
Endüstriyel Mutfaklar
Çamaşırhaneler
Otoparklar
Açık Alanlar
Tüneller

APPLICATION AREAS

Factories
Industrial Kitchens
Laundries
Parking Areas
Outdoor Areas
Tunnels

DOMAINES D'UTILISATION

Usines
Cuisines Industrielles
Blanchisseries
Parkings
Espaces Extérieurs
Tunnels

GÖVDE

Polikarbon veya ABS gri renkli gövde ve polikarbon kilitleme mandalları.

DİFÜZÖR

Yüksek ışık geçirgenliğine sahip polikarbon difüzör.

ASKI SACI

0.5 mm kalınlığında paslanmaz çelik sac.

REFLEKTÖR

Beyaz elektrostatik toz boyalı, 0.5 mm DKP sac.

BALAST (T5 Modeller için)

ENEC standartlarına uygun, uzun ömürlü sabit ışık akısına sahip, düşük enerji kayıplı (EEI=A2) elektronik balast.

KONVERTÖR (LED'li Modeller için)

ENEC standartlarına uygun, uzun ömürlü sabit akımlı konvertör.

LED (LED'li Modeller için)

50.000 saat ömürlü LUMILEDS / OSRAM / SEOUL marka LED'li LED modülleri.

BODY

Polycarbonate or ABS body of gray color with polycarbonate diffuser holder.

DIFFUSER

Polycarbonate diffuser with high light transparency.

CEILING FIXING BRACE

Stainless steel sheet metal with 0.5 mm thickness.

REFLECTOR

White electrostatic powder coated, sheet metal with 0.5 mm thickness.

BALLAST (For T5 Models)

Electronic ballast with long life, low power loss EEI = A2 and constant flux. Compatible with ENEC standards.

CONVERTER (For LED Models)

Long life, low power loss converter with constant current. Compatible with ENEC standards.

LED (For LED Models)

LED modules with 50,000 hours lifetime LUMILEDS / OSRAM / SEOUL brand LEDs.

CORPS

Corps gris en Polycarbonate ou ABS avec porteur du diffuseur en polycarbonate.

DIFFUSEUR

En polycarbonate. Permet une tres grande diffusion de la lumière.

ACCOLADE DE FIXATION AU PLAFOND

Feuille d'acier inoxydable de 0.5 mm d'épaisseur.

REFLECTEUR

Feuille métallique de 0.5 mm d'épaisseur et peinte en blanc électrostatiquement.

BALLAST (Pour T5 Modèles)

Ballast électronique, conforme aux normes ENEC. Longue vie. Perte de puissance faible (EEI = A2). Flux de lumière régulier.

CONVERTEUR (Pour Modèles LED)

Convertisseur, conforme aux normes ENEC. Longue vie. Perte de puissance faible avec courant constant.

LED (Pour Modèles LED)

Modules LED - Durée de vie 50.000 heures avec LED de marque LUMILEDS / OSRAM / SEOUL.

LED'li Tip / LED Type / Type LED

Renk Geri Verim Indexi / Color Rendering Index / Indice de Rendu des Couleurs: (CRI): Ra>80

Kod Code	Güç Power Puissance (W)	LED Tipi LED Type Type De LED	LED Modül LED Module Module LED	Işık Akısı Lum. Flux Flux Lum. (lm)	Renk Sıcaklığı Color Temperature Température De Couleur (K)	Ölçüler Dimensions (mm) a b h			Ağırlık Weight Poids (kg)	Ambalaj Adedi Packing Quantity Colisage	Adet/20" Konteyner Pcs./20" Conteneur
EAL22L15C	4x6,5	3535 SMD	PCB	3400	3000 / 4000 / 6500	670	140	102	1.2	9	3015
EAL24L15C	8x6,5	3535 SMD	PCB	6800	3000 / 4000 / 6500	1280	140	102	2.2	6	1560
EAL25L15C	10x6,5	3535 SMD	PCB	8500	3000 / 4000 / 6500	1570	140	102	2.6	6	1350

T5 Floresanlı Tip / T5 Fluorescent Type / Type T5 Fluorescent

Kod Code	Güç Power Puissance (W)	Ampul Tipi Lamp Type Type De Lampe	Duy Tipi Socket Type Type De Douille	Işık Akısı Lum. Flux Flux Lum. (lm)	Akım Current Courant (A)	Ölçüler Dimensions (mm) a b h			Ağırlık Weight Poids (kg)	Ambalaj Adedi Packing Quantity Colisage	Adet/20" Konteyner Pcs./20" Conteneur
EAEB 228	2x28	T16(T5)	G5	5200	0.26	1280	140	102	2.18	6	1560
EAEB 254	2x54	T16(T5)	G5	8900	0.50	1280	140	102	2.18	6	1560
EAEB 235	2x35	T16(T5)	G5	6600	0.33	1570	140	102	2.65	6	1350
EAEB 249	2x49	T16(T5)	G5	8600	0.49	1570	140	102	2.65	6	1350
EAEB 280	2x80	T16(T5)	G5	12300	0.76	1570	140	102	2.65	6	1350

Opsiyonlar	Options	Options
DIM edilebilir elektronik balast ya da konvertör.	Dimmable electronic ballast or converter.	Ballast électronique dimmable ou converteur.
Acil durum kit.	Emergency kit.	Kit d'urgence.

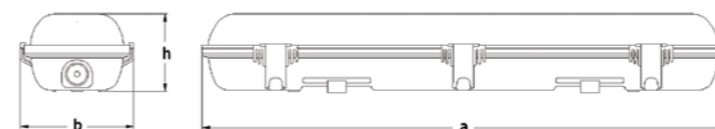

V / Hz 220 - 240 / 50 - 60

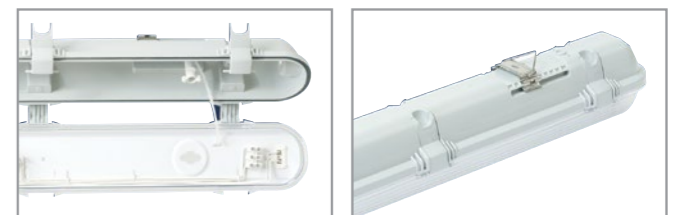

ETANJ WATERPROOF ETANCHE

T26 (T8)

1X Etanj Aydınlatma Armatürleri

1X Waterproof Lighting Fixtures

Luminaire Etanches 1X

UYGULAMA ALANLARI

Fabrikalar
Endüstriyel Mutfaklar
Çamaşırhaneler
Otoparklar
Açık Alanlar
Tüneller

APPLICATION AREAS

Factories
Industrial Kitchens
Laundries
Parking Areas
Outdoor Areas
Tunnels

DOMAINES D'UTILISATION

Usines
Cuisines Industrielles
Blanchisseries
Parkings
Espaces Extérieurs
Tunnels

GÖVDE

Polikarbon veya ABS gri renkli gövde ve polikarbon kilitleme mandalları.

DİFÜZÖR

Yüksek ışık geçirgenliğine sahip polikarbon difüzör.

ASKI SACI

0.5 mm kalınlığında paslanmaz çelik sac.

REFLEKTÖR

Beyaz elektrostatik toz boyalı, 0.5 mm DKP sac.

BALAST

EN normlarına uygun manyetik yada elektronik balast.

BODY

Polycarbonate or ABS body of gray color with polycarbonate diffuser holder.

DIFFUSER

Polycarbonate diffuser with high light transparency.

CEILING FIXING BRACE

Stainless steel sheet metal with 0.5 mm thickness.

REFLECTOR

White electrostatic powder coated, sheet metal with 0.5 mm thickness.

BALLAST

Electronic or magnetic ballast with EN norms.

CORPS

Corps gris en Polycarbonate ou ABS avec porteur du diffuseur en polycarbonate.

DIFFUSEUR

En polycarbonate. Permet une très grande diffusion de la lumière.

ACCOLADE DE FIXATION AU PLAFOND

Feuille d'acier inoxydable de 0.5 mm d'épaisseur.

REFLECTEUR

Feuille métallique de 0.5 mm d'épaisseur et peinte en blanc électrostatiquement.

BALLAST

Ballast électronique ou magnétique. Compatible avec les standards ENEC.

Kod Code	Güç Power Puissance (W)	Ampul Tipi Lamp Type Type De Lampe	Duy Tipi Socket Type Type De Douille	Işık Akısı Lum. Flux Flux Lum. (lm)	Akım Current Courant (A)	Ölçüler Dimensions (mm)			Ağırlık Weight Poids (kg)	Ambalaj Adedi Packing Quantity Colisage	Adet/20" Konteyner Pcs./20" Conteneur	Balast Tipi Ballast Type Type de Balast
						a	b	h				
EAMB 118	1x18	T26 (T8)	G13	1350	0.37	670	95	102	1.30	9	4230	Manyetik Magnétique
EAMB 136	1x36	T26 (T8)	G13	3250	0.43	1280	95	102	1.99	9	2250	Manyetik Magnétique
EAEB 118	1x18	T26 (T8)	G13	1350	0.08	670	95	102	0.99	9	4230	Elektronik Electronique
EAEB 136	1x36	T26 (T8)	G13	3250	0.17	1280	95	102	1.70	9	2250	Elektronik Electronique
EAEB 158	1x58	T26 (T8)	G13	5200	0.24	1570	95	102	2.05	6	1710	Elektronik Electronique

Led Tüp Tesisatlı / With Led Tube Wiring / Avec Cablage Led Tube

Kod Code	Ampul Tipi Lamp Type Type De Lampe	Duy Tipi Socket Type Type De Douille	Ölçüler Dimensions (mm)			Ağırlık Weight Poids (kg)	Ambalaj Adedi Packing Quantity Colisage	Adet/20" Konteyner Pcs./20" Conteneur
			a	b	h			
EA118LD	T26(T8)	G13	670	95	102	0,85	9	4230
EA136LD	T26(T8)	G13	1280	95	102	1,55	9	2250

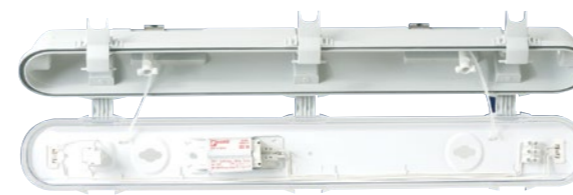

V / Hz 220 - 240 / 50 - 60

Opsiyonlar	Options	Options
DİM edilebilir elektronik balast .	Dimmable electronic ballast.	Ballast électronique dimmable.
Acil durum kit.	Emergency kit.	Kit d'urgence.

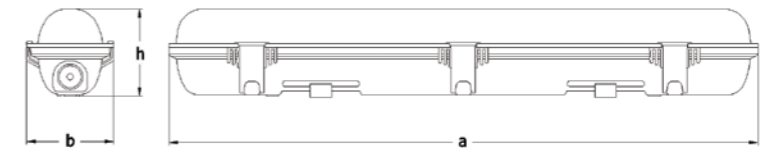



ETANJ WATERPROOF ETANCHE

T26 (T8)

2X Etanj Aydınlatma Armatürleri

2X Waterproof Lighting Fixtures

Luminares Etanches 2X

UYGULAMA ALANLARI

Fabrikalar
Endüstriyel Mutfaklar
Çamaşırhaneler
Otoparklar
Açık Alanlar
Tüneller

APPLICATION AREAS

Factories
Industrial Kitchens
Laundries
Parking Areas
Outdoor Areas
Tunnels

DOMAINES D'UTILISATION

Usines
Cuisines Industrielles
Blanchisseries
Parkings
Espaces Extérieurs
Tunnels

GÖVDE

Polikarbon veya ABS gri renkli gövde ve polikarbon kilitlenme mandalları.

DİFÜZÖR

Yüksek ışık geçirgenliğine sahip polikarbon difüzör.

ASKI SACI

0.5 mm kalınlığında paslanmaz çelik sac.

REFLEKTÖR

Beyaz elektrostatik toz boyalı, 0.5 mm DKP sac.

BALAST

EN normlarına uygun manyetik yada elektronik balast.

BODY

Polycarbonate or ABS body of gray color with polycarbonate diffuser holder.

DIFFUSER

Polycarbonate diffuser with high light transparency.

CEILING FIXING BRACE

Stainless steel sheet metal with 0.5 mm thickness.

REFLECTOR

White electrostatic powder coated, sheet metal with 0.5 mm thickness.

BALLAST

Electronic or magnetic ballast with EN norms.

CORPS

Corps gris en Polycarbonate ou ABS avec porteur du diffuseur en polycarbonate.

DIFFUSEUR

En polycarbonate. Permet une très grande diffusion de la lumière.

ACCOLADE DE FIXATION AU PLAFOND

Feuille d'acier inoxydable de 0.5 mm d'épaisseur.

REFLECTEUR

Feuille métallique de 0.5 mm d'épaisseur et peinte en blanc électrostatiquement.

BALLAST

Ballast électronique ou magnétique. Compatible avec les standards ENEC.

Kod Code	Güç Power Puissance (W)	Ampul Tipi Lamp Type Type De Lampe	Duy Tipi Socket Type Type De Douille	Işık Akısı Lum. Flux Flux Lum. (lm)	Akım Current Courant (A)	Ölçüler Dimensions (mm) a b h	Ağırlık Weight Poids (kg)	Ambalaj Adedi Packing Quantity Colisage	Adet/20" Konteyner Pcs./20" Conteneur	Balast Tipi Ballast Type Type de Balast
EAMB 218	2x18	T26 (T8)	G13	2700	0.37	670 140 102	1.59	9	3015	Manyetik Magnétique
EAMB 236	2x36	T26 (T8)	G13	6500	0.86	1280 140 102	2.96	9	1560	Manyetik Magnétique
EAEB 218	2x18	T26 (T8)	G13	2700	0.18	670 140 102	1.30	9	3015	Elektronik Electronique
EAEB 236	2x36	T26 (T8)	G13	6500	0.32	1280 140 102	2.18	9	1560	Elektronik Electronique
EAEB 258	2x58	T26 (T8)	G13	10400	0.48	1570 140 102	2.64	6	1350	Elektronik Electronique

Led Tüp Tesisatlı / With Led Tube Wiring / Avec Cablage Led Tube

Kod Code	Ampul Tipi Lamp Type Type De Lampe	Duy Tipi Socket Type Type De Douille	Ölçüler Dimensions (mm) a b h	Ağırlık Weight Poids (kg)	Ambalaj Adedi Packing Quantity Colisage	Adet/20" Konteyner Pcs./20" Conteneur
EA218LD	T26(T8)	G13	670 140 102	1,15	9	3015
EA236LD	T26(T8)	G13	1280 140 102	2,10	6	1560

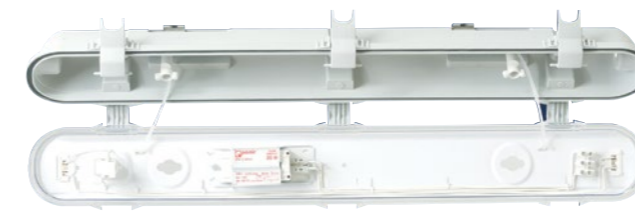

V / Hz 220 - 240 / 50 - 60

Opsiyonlar	Options	Options
DIM edilebilir elektronik balast .	Dimmable electronic ballast.	Ballast électronique dimmable.
Acil durum kit.	Emergency kit.	Kit d'urgence.

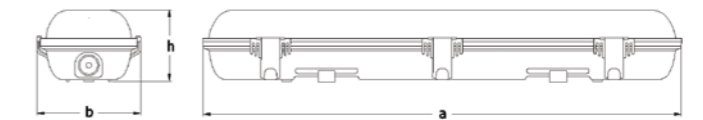





SAC GLOP



E27

Glop Armatürler

Glop Lamps

Hublots

GÖVDE

RAL 9016 elektrostatik toz boyalı DKP sac.

CAM

Buzlu cam.

BODY

RAL 9016 electrostatic powder coated sheetmetal.

GLASS

Frosted glass.

CORPS

RAL 9016 Feuille de métal peinte électrostatiquement.

VERRE

Verre givré.

UYGULAMA ALANLARI

Bina girişlerinde
Merdiven boşluklarında
Koridorlarda
Gerekli diğer tüm konumlarda

APPLICATION AREAS

Building entrances
Stairways
Corridors
All other necessary places

DOMAINES D'UTILISATION

Entrées de bâtiment
Escaliers
Corridors
Et tout autre lieu si nécessaire

Kod Code	Güç Power Puissance (W)	Ağırlık Weight Poids (kg)	Duy Tipi Socket Type Type De Douille	Ölçüler Dimensions (mm)		Ambalaj Adedi Packing Quantity Colisage	Adet/20" Konteyner Pcs./20" Container Pcs./20" Conteneur
GLS 10	1x60	0.8	1xE-27	250	100	12	4400
GLS 12	2x60	1.3	2xE-27	300	100	12	3100

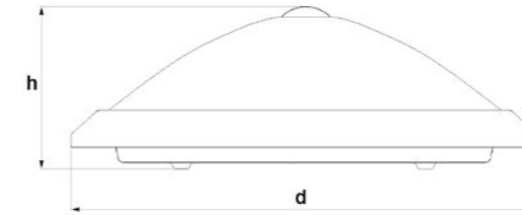



ALÜMİNYUM GLOP

Renk Seçenekleri
Color Options
Options de Couleur



LED / E27 / E14

Glop Armatürler

Glop Lamps

Hublots

UYGULAMA ALANLARI	APPLICATION AREAS	DOMAINES D'UTILISATION
Bina girişlerinde Merdiven boşluklarında Koridorlarda Gerekli diğer tüm konumlarda	Building entrances Stairways Corridors All other necessary places	Entrées de bâtiment Escaliers Corridors Et tout autre lieu si nécessaire

GÖVDE

Beyaz ve siyah renkli, zarif tasarıma sahip, saten eloksallı kaplamalı alüminyum.

CAM

Buzlu cam.

KONVERTÖR (LED'li Modeller için)

ENEC standartlarına uygun, uzun ömürlü sabit akımlı konvertör.

LED (LED'li Modeller için)

50.000 saat ömürlü LED modüller.

BODY

Anodized aluminum with satin finishing, elegant design with black and white color.

GLASS

Frosted glass.

CONVERTER (For LED Models)

Long life, low power loss converter with constant current. Compatible with ENEC standards.

LED (For LED Models)

LED modules with 50,000 hours lifetime.

CORPS

Corps en aluminium anodisé, satiné. Design elegant couleur blanc et noir.

VERRE

Verre givré

CONVERTEUR (Pour Modèles LED)

Convertisseur, conforme aux normes ENEC. Longue vie. Perte de puissance faible avec courant constant.

LED (Pour Modèles LED)

Modules LED – Durée de vie 50.000 heures.

Ampullü Tip / Bulb Type / Type d'ampoule

Kod Code	Güç Power Puissance (W)	Ağırlık Weight Poids (kg)	Duy Tipi Socket Type Type De Douille	Ölçüler Dimensions (mm) d h	Ambalaj Adedi Packing Quantity Colisage	Adet/20" Konteyner Pcs./20" Conteneur
AG 14	2x60	1.4	2xE-14	300 53	10	5000
AG 14R*	2x60	1.5	2xE-14	300 53	10	5000
AG 27	2x60	1.5	2xE-27	300 53	10	5000
AG 27R*	2x60	1.6	2xE-27	300 53	10	5000

LED'li Tip / LED Type / Type LED

Kod Code	Güç Power Puissance (W)	Ağırlık Weight Poids (kg)	LED Tipi LED Type Type De LED	Ölçüler Dimensions (mm) d h	Ambalaj Adedi Packing Quantity Colisage	Adet/20" Konteyner Pcs./20" Conteneur
AGL	20	1.5	3535 SMD	300 53	10	5000
AGLR*	20	1.6	3535 SMD	300 53	10	5000

Opsiyonlar	Options	Options
Ledli acil durum kit.	Emergency kit with led.	Kit d'urgence avec led.
*Radar Sensör	*Microwave Sensor	*Décteur de Micro Onde

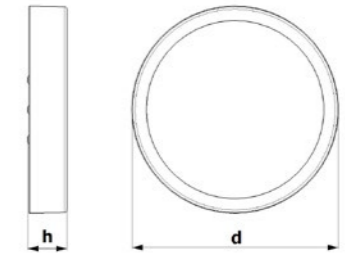



UFO GLOP

Renk Seçenekleri
Color Options
Options de Couleur



Beyaz/White/Blanc



Krom/Chrome



LED / E27

Glop Armatürler

Glop Lamps

Hublots

UYGULAMA ALANLARI	APPLICATION AREAS	DOMAINES D'UTILISATION
Bina girişlerinde Merdiven boşluklarında Koridorlarda Gerekli diğer tüm konumlarda	Building entrances Stairways Corridors All other necessary places	Entrées de bâtiment Escaliers Corridors Et tout autre lieu si nécessaire

GÖVDE

RAL 9016 elektrostatik toz boyalı DKP sac.

CAM

Buzlu cam.

KONVERTÖR (LED'li Modeller için)

ENEC standartlarına uygun, uzun ömürlü sabit akımlı konvertör.

LED (LED'li Modeller için)

50.000 saat ömürlü LED modüller.

BODY

RAL 9016 electrostatic powder coated sheetmetal.

GLASS

Frosted glass.

CONVERTER (For LED Models)

Long life, low power loss converter with constant current. Compatible with ENEC standards.

LED (For LED Models)

LED modules with 50,000 hours lifetime.

CORPS

RAL 9016 Feuille de métal peinte électrostatiquement.

VERRE

Verre givré.

CONVERTEUR (Pour Modèles LED)

Convertisseur, conforme aux normes ENEC. Longue vie. Perte de puissance faible avec courant constant.

LED (Pour Modèles LED)

Modules LED – Durée de vie 50.000 heures.

Ampullü Tip / Bulb Type / Type d'ampoule

Kod Code	Güç Power Puissance (W)	Renk Color Couleur	Ağırlık Weight Poids (kg)	Duy Tipi Socket Type Type De Douille	Ölçüler Dimensions (mm) d h	Ambalaj Adedi Packing Quantity Colisage	Adet/20" Konteyner Pcs./20" Container Pcs./20" Conteneur
GLS 20	1x60	Beyaz/White/Blanc	1.1	1xE-27	280 68	12	4700
GLS 22	1x60	Krom/Chrome	1.1	1xE-27	280 68	12	4700

LED'li Tip / LED Type / Type LED

Kod Code	Güç Power Puissance (W)	Renk Color Couleur	Ağırlık Weight Poids (kg)	LED Tipi LED Type Type De LED	Ölçüler Dimensions (mm) d h	Ambalaj Adedi Packing Quantity Colisage	Adet/20" Konteyner Pcs./20" Container Pcs./20" Conteneur
GLS 30	20	Beyaz/White/Blanc	1.0	2835 SMD	280 68	12	4700
GLS 32	20	Krom/Chrome	1.0	2835 SMD	280 68	12	4700

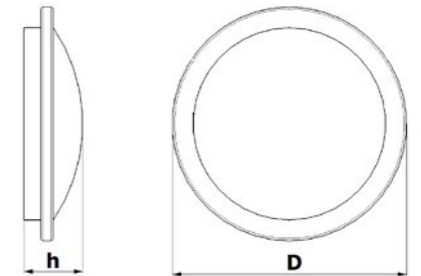



 **pamir**[®]
aydınlık

SENSÖR / SENSOR / DÉTECTEUR

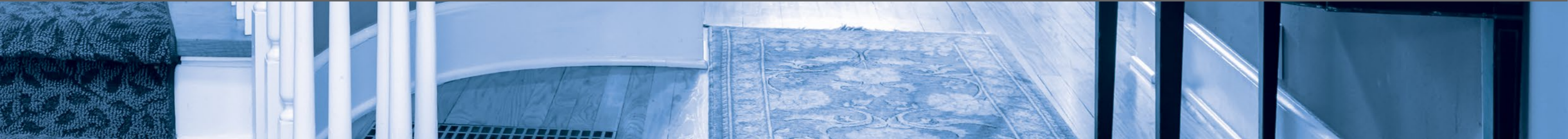



LED / E27

Hareket Sensörlü Tavan Armatürü

Motion Sensor Lamp

Hublot Avec Détecteur De Mouvement

UYGULAMA ALANLARI	APPLICATION AREAS	DOMAINES D'UTILISATION
Bina girişlerinde Merdiven boşluklarında Koridorlarda Gerekli diğer tüm konumlarda	Building entrances Stairways Corridors All other necessary places	Entrées de bâtiment Escaliers Corridors Et tout autre lieu si nécessaire

GÖVDE

RAL 9016 elektrostatik toz boyalı DKP sac.

CAM

Buzlu cam.

KONVERTÖR (LED'li Modeller için)

ENEC standartlarına uygun, uzun ömürlü sabit akımlı konvertör.

LED (LED'li Modeller için)

50.000 saat ömürlü LED modüller.

BODY

RAL 9016 electrostatic powder coated sheetmetal.

GLASS

Frosted glass.

CONVERTER (For LED Models)

Long life, low power loss converter with constant current. Compatible with ENEC standards.

LED (For LED Models)

LED modules with 50,000 hours lifetime.

CORPS

RAL 9016 Feuille de métal peinte électrostatiquement.

VERRE

Verre givré.

CONVERTEUR (Pour Modèles LED)

Convertisseur, conforme aux normes ENEC. Longue vie. Perte de puissance faible avec courant constant.

LED (Pour Modèles LED)

Modules LED – Durée de vie 50.000 heures.

Ampullü Tip / Bulb Type / Type d'ampoule

Kod Code	Güç Power Puissance (W)	Ağırlık Weight Poids (kg)	Duy Tipi Socket Type Type De Douille	Ölçüler Dimensions (mm) d h	Ambalaj Adedi Packing Quantity Colisage	Adet/20" Konteyner Pcs./20" Conteneur
SGS 10	2x25	1.1	2xE-27	300 105	12	3100
SGS 10K	2x25	1.2	2xE-27	300 105	12	3100

LED'li Tip / LED Type / Type LED

Kod Code	Güç Power Puissance (W)	Ağırlık Weight Poids (kg)	LED Tipi LED Type Type De LED	Ölçüler Dimensions (mm) d h	Ambalaj Adedi Packing Quantity Colisage	Adet/20" Konteyner Pcs./20" Conteneur
SGS 20	24	1.0	2835 SMD	300 105	12	3100
SGS 20K	24	1.1	2835 SMD	300 105	12	3100

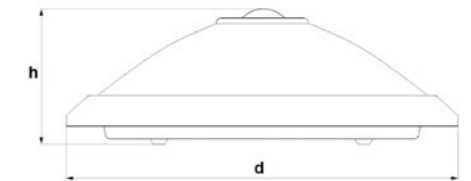

Opsiyonlar	Options	Options
Ledli acil durum kiti.	Emergency kit with led.	Kit d'urgence avec led.

Teknik Özellikleri	Technical Specifications	Spécifications Techniques
Gerilim: 230V ~ 50 Hz Algılama Açısı: 360° Montaj Yüksekliği: 3m ± 20cm Algılama Genişliği: 9m ± 40cm Zaman Aralığı: 15 - 45 s	Voltage: 230V ~ 50 Hz Detection Angle: 360° Optimum Mounting Height: 3m ± 20cm Detection Width: 9m ± 40cm Time Setting: 15 - 45 sec	Voltage: 230V ~ 50 Hz Angle de Détection: 360° Hauteur Optimale de Montage: 3m ± 20cm Largeur de Détection: 9m ± 40cm Durée Réglable: 15 - 45 sec

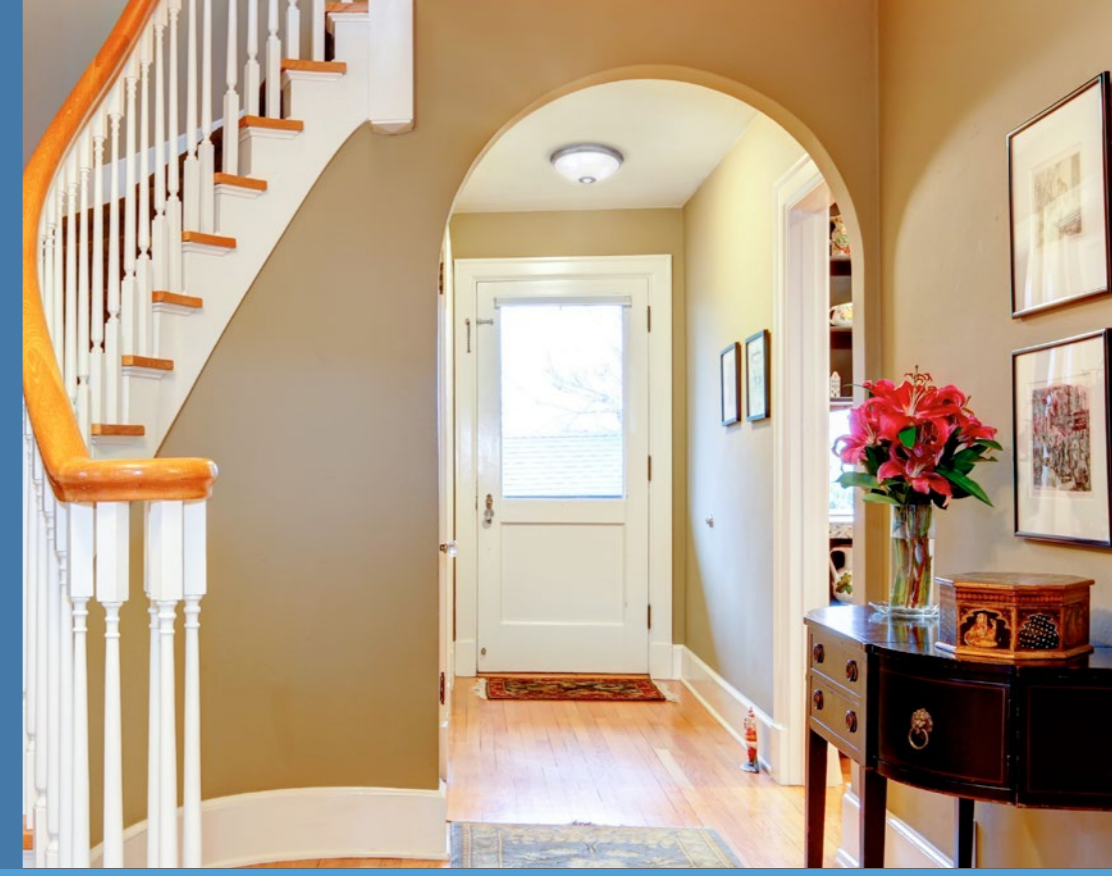

E27 Hareket Sensörlü Tavan Armatürü Motion Sensor Lamp Hublot Avec Détecteur De Mouvement

UYGULAMA ALANLARI	APPLICATION AREAS	DOMAINES D'UTILISATION
Bina girişlerinde Merdiven boşluklarında Koridorlarda Gerekli diğer tüm konumlarda	Building entrances Stairways Corridors All other necessary places	Entrées de bâtiment Escaliers Corridors Et tout autre lieu si nécessaire

Kod Code	Güç Power Puissance (W)	Ağırlık Weight Poids (kg)	Duy Tipi Socket Type Type De Douille	Ölçüler Dimensions (mm) d h	Ambalaj Adedi Packing Quantity Colisage	Adet/20" Konteyner Pcs./20" Container Pcs./20" Conteneur
SG 10	2x40	0.49	E-27	296 104	10	3100
SG 13C	2x40	0.49	E-27	296 104	10	3100
SG 13M	2x40	0.49	E-27	296 104	10	3100

Teknik Özellikleri	Technical Specifications	Spécifications Techniques
Gerilim: 230V ~ 50 Hz Algılama Açısı: 360° Montaj Yüksekliği: 3m ± 20cm Algılama Genişliği: 14m ± 40cm Zaman Aralığı: 8sec - 8 min	Voltage: 230V ~ 50 Hz Detection Angle: 360° Optimum Mounting Height: 3m ± 20cm Detection Width: 14m ± 40cm Time Setting: 8sec - 8 min	Voltage: 230V ~ 50 Hz Angle de Détection: 360° Hauteur Optimale de Montage: 3m + 20cm Largeur de Détection: 14m + 40cm Durée Réglable: 8sec - 8 min

PARÇALAR / PARTS / PARTIES	MALZEMELER / MATERIALS / MATIERES	RENK / COLOR / COULEUR
Gövde / Body / Corps	ABS	Beyaz- Kaplama / White - Coated / Blanc - Peint
Lamba Kapağı / Lamp Cover / Couvercle	PS	Şeffaf / Transparent
Duy / Lamp Holder / Douille	Porselen / Porcelain / Porcelaine	Beyaz / White / Blanc
Reflektör / Reflector / Réflecteur	Alüminyum / Aluminium	Metalik / Metallic / Métallisé

Ampul / Bulb / Ampoule  E-27
Pcs. Güç / Power / Puissance
2 40 W

Patent No: 2007 05409

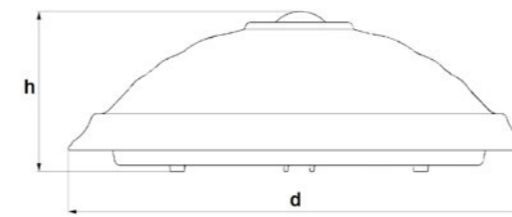



Hareket Sensörü

Motion Sensor

Décteur De Mouvement

UYGULAMA ALANLARI

Bina girişlerinde
Merdiven boşluklarında
Koridorlarda
Otoparklar
Gerekli diğer tüm
konumlarda

APPLICATION AREAS

Building entrances
Stairways
Corridors
Parking areas
All other necessary
places

DOMAINES D'UTILISATION

Entrées de bâtiment
Escaliers
Corridors
Parkings
Et tout autre lieu si
nécessaire

Kod Code	Ölçüler Dimensions (mm)		Ambalaj Adedi Pcs / Inner Packing Pcs / Emballage Interne	Kolideki Adet Pcs / Outer Packing Pcs / Emballage Externe	Adet/20" Konteyner Pcs./20" Container Pcs./20" Conteneur	Gövde Body Corps
	d	h				
SN-10	112	52	1	24	31080	ABS

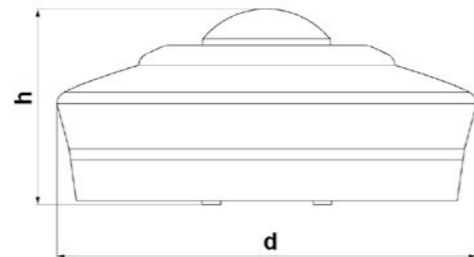

Teknik Özellikleri	Technical Specifications	Spécifications Techniques
Gerilim: 230V ~ 50 Hz IP 30 Güç: Max 1500W (Enkandesent Ampul) Max 750W (Floresan Ampul) Algılama Açısı: 360° Montaj Yüksekliği: 3m ± 20cm Algılama Genişliği: 14m ± 50 cm Zaman Aralığı: 8 sec - 8 min	Voltage: 230V ~ 50 Hz IP 30 Power: Max 1500W (Incandescent Bulbs) Max 750W (Fluorescent Lamps) Detection Angle: 360° Optimum Mounting Height: 3m ± 20cm Detection Width: 14m ± 50 cm Time Setting: 8 sec - 8 min	Voltage: 230V ~ 50 Hz IP 30 Puissance: Max 1500W (Ampoules Incandescentes) Max 750W (Lampes Fluorescentes) Angle de Détection: 360° Hauteur Optimale de Montage: 3m + 20cm Largeur de Détection: 14m + 40 cm Durée Réglable: 8 sec - 8 min



SN 10



Patent No: 2005 02393

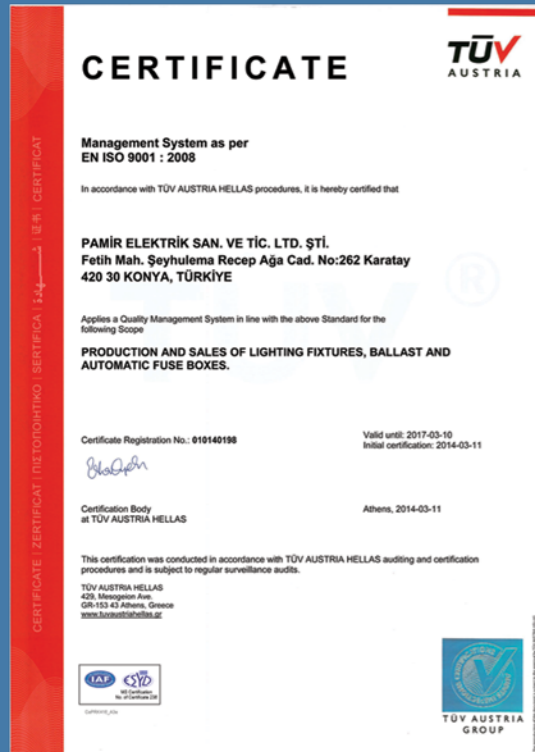
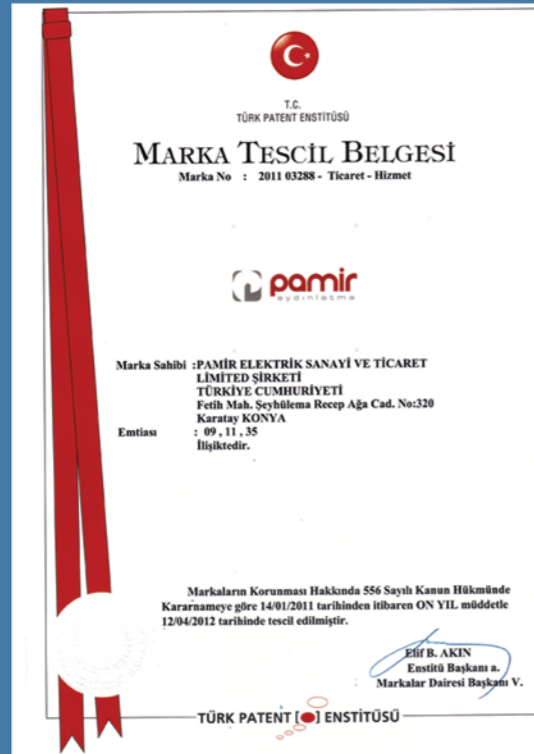

TÜRK STANDARTLARI ENSTİTÜSÜ

TSE-HYB

HİZMET YETERLİLİK BELGESİ

Belge No	:H24YB-627
İlk Veriliş Tarihi	:27.06.2008
Son Değerlendirme Tarihi	:27.06.2016
Firmanın Adı	: RAMİR ELEKTRİK SANAYİ VE TİCARET LTD.ŞTİ.
Firmanın Adresi	:FETHİ MAH. SEYİHÜLEMA REZERVAĞI CAD. NO:262 KARATAY KONYA/TÜRKİYE
Hizmet Yeri Adresi	:FETHİ MAH. SEYİHÜLEMA REZERVAĞI CAD. NO:262 KARATAY KONYA/TÜRKİYE
Sıklık	:25938

Verilen Hizmetin Kapsamı

1.758 (17.12.2008)YETKİLİ BİRİMLER – AYDINLATMA ARMATÜRLERİNE BAKIM ONARIMI VE MONTAJ – HİZMETİ
 VEREN ÜYELERİN HİZMET YETERLİLİK BELGESİ VERİLMESİNE İZAH KUTUPLER STANDARTINA UYGUN
 HİZMET YERİNE
 RAMİR ELEKTRİK SANAYİ VE TİCARET LTD. ŞTİ. YETKİLİ SERVİSİ (24291)
 (27.06.2008) (RAMİR) MARUFAI

15.06.2015

İMZA VE MÜHÜR AYDEMİR KONYA BELGELENDİRME MÜDÜRÜ

Organik Sanayi Bölgesi Yoluyla Cel. Kızılayın Sokağı 4200 KONYA Telefon: +90 332 239 54 80 (24) 0239 84 84 Faks: +90 332 239 54 80

ТАМОЖЕННЫЙ СОЮЗ

СЕРТИФИКАТ СООТВЕТСТВИЯ

№ ТС RU C-TR.M002.B.01541

Серия RU № 0244476

ОРГАН ПО СЕРТИФИКАЦИИ Организация Общества с ограниченной ответственностью «ПРОММАШ ТЕСТ». Место нахождения: 113114, Российская Федерация, город Москва, Дербовская набережная, дом 11, помещение 60. Фактический адрес: 113114, Российская Федерация, город Москва, Дербовская набережная, дом 11, помещение 60. Телефон: +7 (495) 775-48-45, факс: +7 (495) 775-48-43, адрес электронной почты: info@prommash.ru. Адрес аттестации регистрационный № РОСС RU.0001.11M002 выдан 01.12.2014 года Федеральной службой по аккредитации

ЗАЯВИТЕЛЬ «RAMİR ELEKTRİK SANAYİ VE TİCARET LTD.ŞTİ.» Место нахождения: Турция, Fethi Mah. Seyihulema Reser Aga Cad. No.262 Karatay-Konya Фактический адрес: Турция, Fethi Mah. Seyihulema Reser Aga Cad. No.262 Karatay-Konya Телефон: 903323558616, факс: 903323558612, адрес электронной почты: export@ramir.com.tr

ИЗГОТОВИТЕЛЬ «RAMİR ELEKTRİK SANAYİ VE TİCARET LTD.ŞTİ.» Место нахождения: Турция, Fethi Mah. Seyihulema Reser Aga Cad. No.262 Karatay-Konya Фактический адрес: Турция, Fethi Mah. Seyihulema Reser Aga Cad. No.262 Karatay-Konya

ПРОДУКЦИЯ Системный блок с сетевыми и коммутационными аппаратами торговой марки «RAMİR AYDINLATMA», изготовляемые по ИЕС 60598-1, 2006/95/ЕС, 2006/95/АТ, 2004/108/ЕС. Серебряный выпуск

КОД ТН ВЭД ТС 9405 10 910 9

СООТВЕТСТВУЕТ ТРЕБОВАНИЯМ Технического регламента Таможенного союза ТР ТС 004/2011 "О безопасности низковольтного оборудования"

СЕРТИФИКАТ ВЫДАН НА ОСНОВАНИИ протокола испытаний №М 227-02-15, 230-02-15 от 27.02.2015 года. Испытательный центр Общества с ограниченной ответственностью «АкадемСиб», аттестат аккредитации регистрационный № РОСС RU.0001.21A809 действителен до 01.08.2016 года, фактический адрес: 630024, Российская Федерация, Новосибирская область, город Новосибирск, улица Бетонная, дом 14; дата анализа состояния производства № 011819АТ от 02.02.2015 года органа по сертификации продукции Общества с ограниченной ответственностью «ПРОММАШ ТЕСТ»

ДОПОЛНИТЕЛЬНАЯ ИНФОРМАЦИЯ Срок службы 5-10 лет согласно технической документации изготовителя. Срок с момента выдачи в таможенно-сертификационной документации, утвержденной в установленном законодательстве. Организация с ограниченной ответственностью «СТАДАРТ ЭИЦ ПАУЗР» по договору № 8498 от 07.12.2013 года. Место нахождения: 107113, Россия, город Москва, улица Мухоморова, дом 14, корпус 3. Телефон: +7(495)2478116, факс: +7(495)2478116, адрес электронной почты: info@stadart.ru. Основной подконтрольный регистрационный номер 11279647833.

СРОК ДЕЙСТВИЯ С 04.03.2015 **ПО** 03.03.2018 **ВКЛЮЧИТЕЛЬНО**

М.П. Руководитель (подпись/подпись) А.П. Филатчев
 (инициалы, фамилия)
 Эксперт (подпись/подпись) Е.В. Морозова
 (инициалы, фамилия)

ТАМОЖЕННЫЙ СОЮЗ

СЕРТИФИКАТ СООТВЕТСТВИЯ

№ ТС RU C-TR.M002.B.01540

Серия RU № 0244475

ОРГАН ПО СЕРТИФИКАЦИИ Организация Общества с ограниченной ответственностью «ПРОММАШ ТЕСТ». Место нахождения: 113114, Российская Федерация, город Москва, Дербовская набережная, дом 11, помещение 60. Фактический адрес: 113114, Российская Федерация, город Москва, Дербовская набережная, дом 11, помещение 60. Телефон: +7 (495) 775-48-45, факс: +7 (495) 775-48-43, адрес электронной почты: info@prommash.ru. Адрес аттестации регистрационный № РОСС RU.0001.11M002 выдан 01.12.2014 года Федеральной службой по аккредитации

ЗАЯВИТЕЛЬ «RAMİR ELEKTRİK SANAYİ VE TİCARET LTD.ŞTİ.» Место нахождения: Турция, Fethi Mah. Seyihulema Reser Aga Cad. No.262 Karatay-Konya Фактический адрес: Турция, Fethi Mah. Seyihulema Reser Aga Cad. No.262 Karatay-Konya Телефон: 9033235 58616, факс: 903323558612, адрес электронной почты: export@ramir.com.tr

ИЗГОТОВИТЕЛЬ «RAMİR ELEKTRİK SANAYİ VE TİCARET LTD.ŞTİ.» Место нахождения: Турция, Fethi Mah. Seyihulema Reser Aga Cad. No.262 Karatay-Konya Фактический адрес: Турция, Fethi Mah. Seyihulema Reser Aga Cad. No.262 Karatay-Konya

ПРОДУКЦИЯ Системный блок с сетевыми и коммутационными аппаратами торговой марки «RAMİR AYDINLATMA», изготовляемые по ИЕС 60598-1, 2006/95/ЕС, 2006/95/АТ, 2004/108/ЕС. Серебряный выпуск

КОД ТН ВЭД ТС 9405 10 980 8

СООТВЕТСТВУЕТ ТРЕБОВАНИЯМ Технического регламента Таможенного союза ТР ТС 004/2011 "О безопасности низковольтного оборудования", Технического регламента Таможенного союза ТР ТС 020/2011 "Электромагнитная совместимость технических средств"

СЕРТИФИКАТ ВЫДАН НА ОСНОВАНИИ протокола испытаний №М 229-02-15, 230-02-15, 231-02-15, 232-02-15 от 27.02.2015 года. Испытательный центр Общества с ограниченной ответственностью «АкадемСиб», аттестат аккредитации регистрационный № РОСС RU.0001.21A809 действителен до 01.08.2016 года, фактический адрес: 630024, Российская Федерация, Новосибирская область, город Новосибирск, улица Бетонная, дом 14; дата анализа состояния производства № 011819АТ от 02.02.2015 года органа по сертификации продукции Общества с ограниченной ответственностью «ПРОММАШ ТЕСТ»

ДОПОЛНИТЕЛЬНАЯ ИНФОРМАЦИЯ Срок службы 5-10 лет согласно технической документации изготовителя. Срок с момента выдачи в таможенно-сертификационной документации, утвержденной в установленном законодательстве. Организация с ограниченной ответственностью «СТАДАРТ ЭИЦ ПАУЗР» по договору № 8498 от 07.12.2013 года. Место нахождения: 107113, Россия, город Москва, улица Мухоморова, дом 14, корпус 3. Телефон: +7(495)2478116, факс: +7(495)2478116, адрес электронной почты: info@stadart.ru. Основной подконтрольный регистрационный номер 11279647833.

СРОК ДЕЙСТВИЯ С 04.03.2015 **ПО** 03.03.2018 **ВКЛЮЧИТЕЛЬНО**

М.П. Руководитель (подпись/подпись) А.П. Филатчев
 (инициалы, фамилия)
 Эксперт (подпись/подпись) Е.В. Морозова
 (инициалы, фамилия)



Fabrika Merkez / Head Office Factory / Direction Générale Usine

Fetih Mah. Şeyhulema Recepağa Cad. No:262 42030 Karatay - Konya / TÜRKİYE
T : +90 332 355 86 16 - F : +90 332 355 86 12

Karaköy Showroom

Emekyemez Mahallesi, Okçumusa Cad. Tezgül İş Merkezi No:2/21 Kat: 2 34421
Şiřhane - Karaköy / İstanbul / TÜRKİYE
T: +90 212 245 05 60 - F: +90 212 245 05 63
E-mail : pamir@pamir.com.tr www.pamir.com.tr